

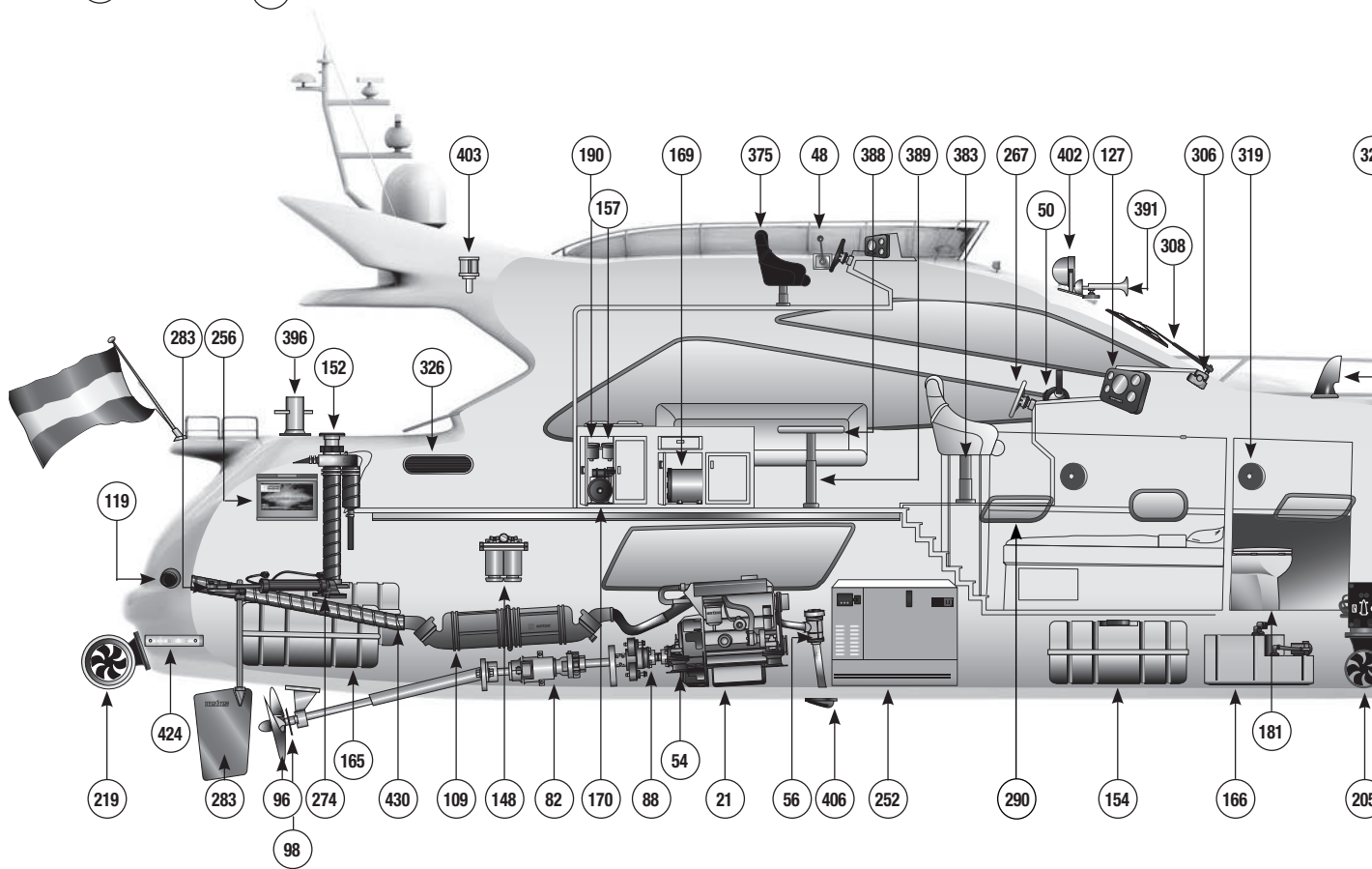

PRIJSLIJST 2022

GELDIG PER 01-04-2022

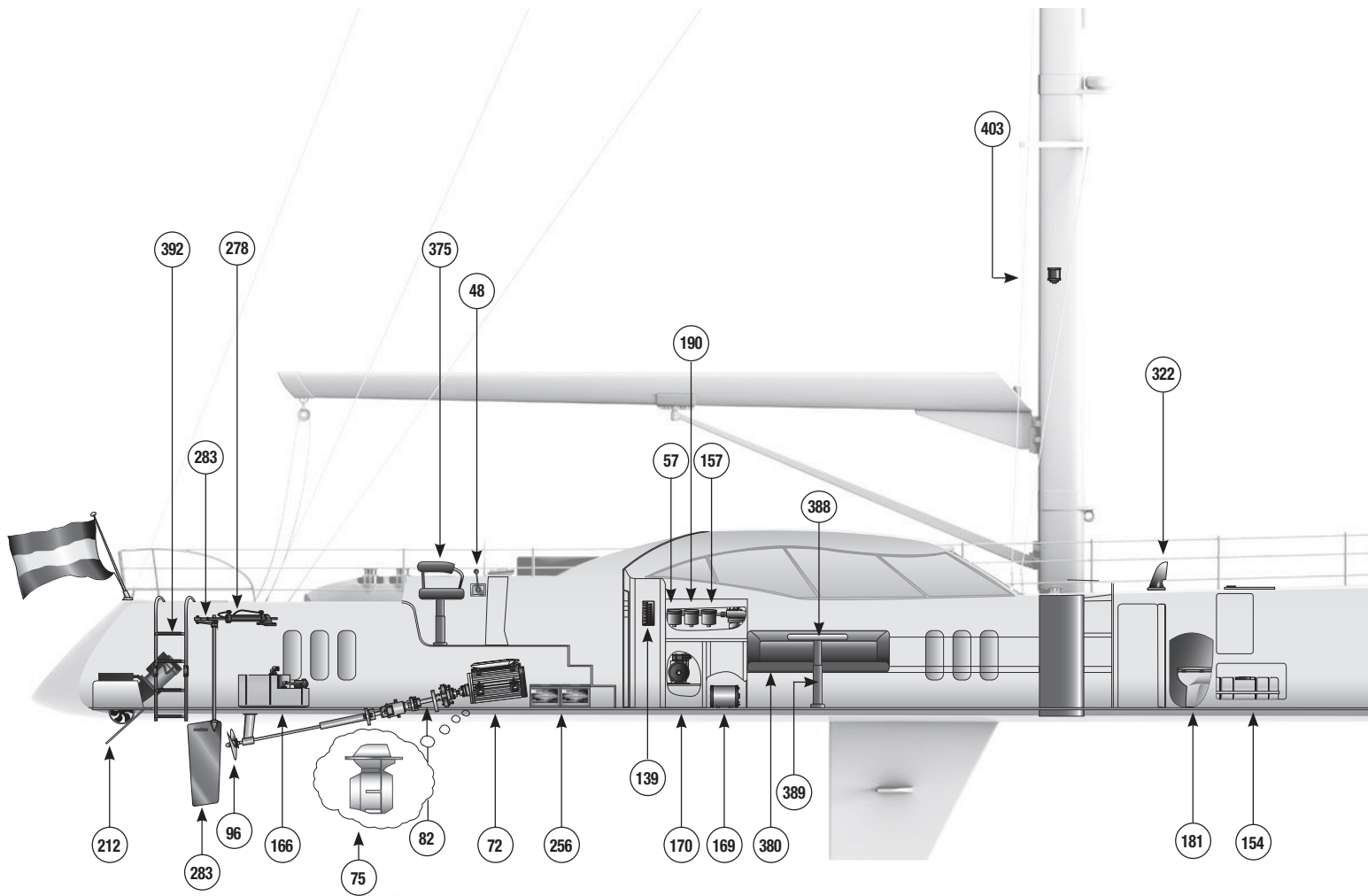

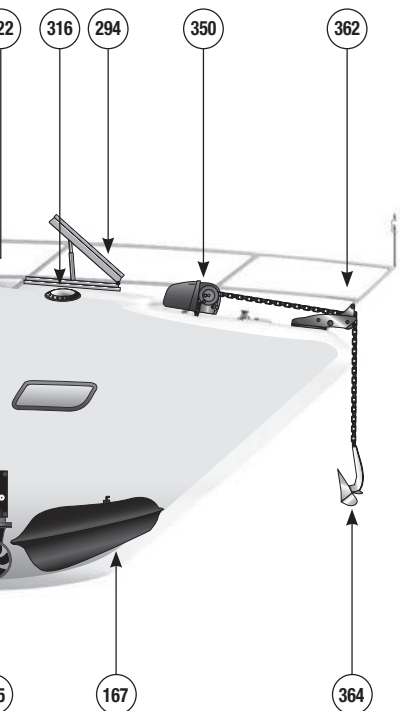
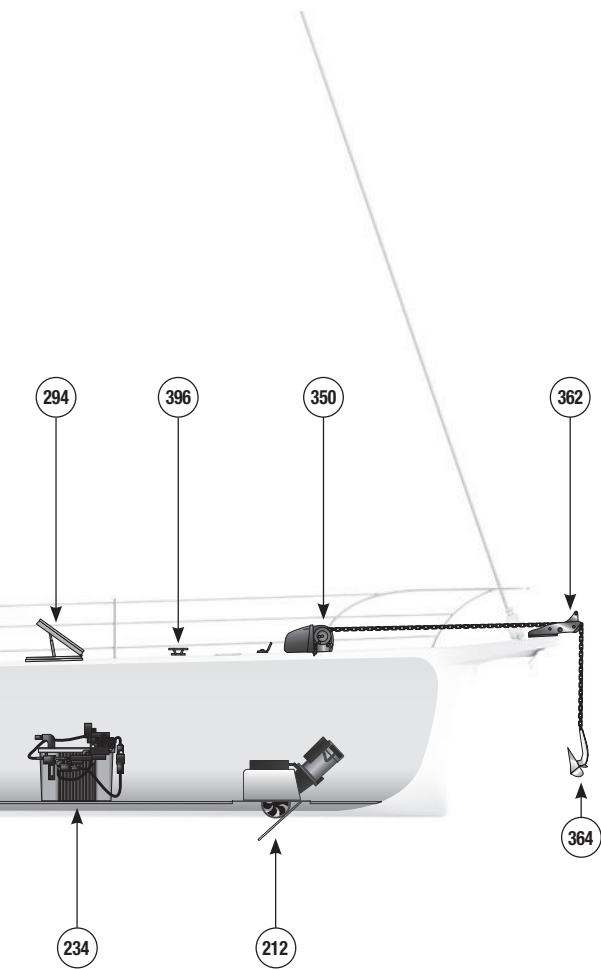

Motoren en rondom de motor
Elektrische voortstuwing
Schroefsystemen
Uitlaatsystemen
Scheepsinstrumenten
Brandstofsysteem
Watersystemen
Vuilwatersystemen
Boegschroefsystemen
Power hydraulica
Stroom aan boord
Stuursystemen
Scheepsbeglazing
Ventilatie
Maxwell ankersystemen
V-Quipment



**MOTOREN EN RONDOM DE MOTOR****SCHEEPSDIESELMOTOREN M-LINE EN H-LINE**

Indien u meer informatie wilt over VETUS dieselmotoren zenden wij u graag op verzoek onze separate documentatie en prijzen toe.

**SCHEEPSDIESELMOTOREN D-LINE EN F-LINE**

Indien u meer informatie wilt over VETUS dieselmotoren zenden wij u graag op verzoek onze separate documentatie en prijzen toe.

**V-CAN**

















9	BPCAB1HF	CAN kabel (halogeenvrij) 1 meter	A	32,19	38,95
	BPCAB5HF	CAN kabel (halogeenvrij) 5 meter	A	45,45	55,00
	BPCAB10HF	CAN kabel (halogeenvrij) 10 meter	A	61,98	75,00
	BPCAB15HF	CAN kabel (halogeenvrij) 15 meter	A	75,21	91,00
	BPCAB20HF	CAN kabel (halogeenvrij) 20 meter	A	91,74	111,00
	BPCAB25HF	CAN kabel (halogeenvrij) 25 meter	A	104,96	127,00
	BPCABCPC	CAN toevoerkabel	A	64,46	78,00
	CANT	CAN t-splitter	A	52,89	64,00
	CANVT	CAN termination resistor	A	29,71	35,95
	BPCBCGC	Verloop kabel	A	22,27	26,95
	BPCANHUB	CAN 3 point Hub	A	53,72	65,00
	CANJ2N1	CANverter 1-richting van J1939 naar NMEA2000	A	222,31	269,00
	CANV2N1	CANverter 1-richting van V-CAN naar NMEA2000	A	222,31	269,00
	CANV2N2	CANverter 2-richting van NMEA2000 naar V-CAN	A	222,31	269,00
	CANV2Y2	CANverter 2-richting van YanmarJ1939 naar V-CAN	A	230,58	279,00
	CANY2N1	CANverter 1-richting van NMEA2000 naar YanmarJ1939	A	230,58	279,00
Nieuw!	CANNS500	Digital Battery Monitoring Shunt NMEA2000 and WiFi connection, max. current 500A	EP	255,37	309,00
	CANNME7	Multifunctioneel display voor elektrische voorstuwing, 7" scherm, NMEA2000	EP	1.304,96	1579,00
10	CANNC01	NMEA2000 kabel stekker en contrastekker, 1 meter	A	23,93	28,95
	CANNC02	NMEA2000 kabel stekker en contrastekker, 2 meter	A	34,67	41,95
	CANNC05	NMEA2000 kabel stekker en contrastekker, 5 meter	A	69,42	84,00
	CANNC10	NMEA2000 kabel stekker en contrastekker, 10 meter	A	113,22	137,00
Nieuw!	DTCAN3M	CAN-bus datakabel 3 m	A	45,45	55,00
Nieuw!	DTCAN5M	CAN-bus datakabel 5 m	A	57,85	70,00
Nieuw!	DTCAN7,5M	CAN-bus datakabel 7,5 m	A	75,21	91,00
Nieuw!	DTCAN10M	CAN-bus datakabel 10 m	A	95,87	116,00
	DTCAN15M	CAN-bus datakabel 15 m	A	140,50	170,00
Nieuw!	DTCAN30M	CAN-bus datakabel 30 m	A	263,64	319,00
	CANNHUB	NMEA2000 drieweg hub stekker-contrastekker-stekker	A	39,63	47,95
Nieuw!	CANVHUB	V-CAN 3 point Hub	A	53,72	65,00
	CANNPSCM	NMEA2000 Stroomvoorziening met stekker, 3A zekering, 1 meter kabel	A	18,97	22,95
	CANNTF	NMEA2000 afsluitweerstand contrastekker - 120 Ohm	A	10,70	12,95
	CANNTM	NMEA2000 afsluitweerstand stekker - 120 Ohm	A	10,70	12,95

**MECHANISCHE MOTOR-AFSTANDSBEDIENING**









48	SISCO	Afstandsbediening zijmontage, huis en handel vervaardigd uit roestvast staal	B	338,02	409,00
	SISCOG	Afstandsbediening zijmontage, huis, handel en knop vervaardigd uit roestvast staal	B	362,81	439,00
	SICO	Afstandsbediening zijmontage, huis uit kunststof, handel uit roestvast staal	B	263,64	319,00
	SICOG	Afstandsbediening zijmontage, huis uit kunststof, handel en knop uit roestvast staal	B	271,90	329,00
	RCTOPS	Afstandsbediening voor 1 motor, topmontage, huis en handel roestvast staal	B	412,40	499,00
	RCTOPSG	Afstandsbediening voor 1 motor, topmontage, huis, handel en knop roestvast staal	B	437,19	529,00
	RCTOPTS	Afstandsbediening voor 2 motoren, topmontage, huis en handel roestvast staal	B	701,65	849,00
	RCTOPTSG	Afstandsbediening voor 2 motoren, topmontage, huis, handel en knop roestvast staal roestvast staal	B	734,71	889,00
49	RCTOPTB	Afstandsbediening voor 2 motoren, topmontage aluminium huis, zwart	B	668,60	809,00
	RCTOPTBG	Afstandsbediening voor 2 motoren, topmontage aluminium huis, zwart, rvs hendel en knop	B	693,39	839,00
	RCTOPB	Afstandsbediening voor 1 motor, topmontage aluminium huis, zwart	B	338,02	409,00
	RCTOPBG	Afstandsbediening voor 1 motor, topmontage aluminium huis, zwart, roestvast stalen hendel en knop	B	362,81	439,00
	AFSTTOPT	Afstandsbediening voor 2 motoren, topmontage kunststof huis (excl. neutraal-schakelaar)	B	751,24	909,00
	AFSTTOP	Afstandsbediening voor 1 motor, topmontage kunststof huis (excl. neutraal-schakelaar)	B	387,60	469,00
	AFSTZIJ	Afstandsbediening voor 1 motor, zijmontage kunststof huis (excl. neutraal-schakelaar)	B	288,43	349,00

**ELECTRONISCHE AFSTANDSBEDIENING VOOR DE MOTOR****TYPE EC4 en EC3**

50	EC4H1	Bedieningshendel roestvrij staal voor 1 motor	B	1.139,67	1379,00
	EC4H1R	Bedieningshendel roestvrij staal (rechts) voor 1 motor	B	1.139,67	1379,00

	EC4HT1	Bedieningshendel roestvrij staal voor 1 motor met TRIM	B	1.197,52	1449,00	
	EC4H2	Bedieningshendel roestvrij staal voor 2 motoren	B	1.197,52	1449,00	
	EC4HT2	Bedieningshendel roestvrij staal voor 2 motoren met TRIM	B	1.263,64	1529,00	
51	EC3UMM1	Schakelkast voor 1 mechanische motor + 1 mechanische keerkoppeling, 12/24 Vdc	B	2.354,55	2849,00	
	EC4UMM1	Schakelkast voor 1 mechanische motor + 1 mechanische keerkoppeling, 12/24 Vdc	B	2.354,55	2849,00	
	EC3UMMT1	Schakelkast voor 1 mechanische motor + 1 mechanische keerkoppeling met TRIM/Flap, 12/24 Volt	B	2.809,09	3399,00	
	EC4UMMT1	Schakelkast voor 1 mechanische motor + 1 mechanische keerkoppeling met TRIM/Flap, 12/24 Volt	B	2.809,09	3399,00	
	EC3UME1	Schakelkast voor 1 mechanische motor + 1 elektronische keerkoppeling, 12/24 Vdc	B	2.147,93	2599,00	
	EC3UME2	Schakelkast voor 2 mechanische motor + 1 elektronische keerkoppeling, 12/24 Vdc	B	3.222,31	3899,00	
	EC3UMET1	Schakelkast voor 1 mechanische motor + 1 elektronische keerkoppeling met TRIM / Flap, 12/24 Vdc	B	2.561,16	3099,00	
	EC4UMET1	Schakelkast voor 1 mechanische motor + 1 elektronische keerkoppeling met TRIM / Flap, 12/24 Vdc	B	2.561,16	3099,00	
	EC3UMET2	Schakelkast voor 2 mechanische motor + 1 elektronische keerkoppeling met TRIM / Flap, 12/24 Vdc	B	3.718,18	4499,00	
	EC4UMET2	Schakelkast voor 2 mechanische motor + 1 elektronische keerkoppeling met TRIM / Flap, 12/24 Vdc	B	3.718,18	4499,00	
	EC3UMETR1	Schakelkast voor 1 mechanische motor en 1 elektronische keerkoppeling met trolling optie	B	3.594,21	4349,00	
	EC4UMETR1	Schakelkast voor 1 mechanische motor en 1 elektronische keerkoppeling met trolling optie	B	3.594,21	4349,00	
	EC312EE	Schakelkast voor elektronische bediening	B	1.511,57	1829,00	
	EC4UEE	Schakelkast voor elektronische bediening	B	1.511,57	1829,00	
	EC312EET	Schakelkast voor elektronische bediening met trolling optie en trim	B	2.726,45	3299,00	
	EC4EETR	Schakelkast voor elektronische bediening met trolling optie en trim	B	2.726,45	3299,00	
	EC312EM1	Schakelkast voor elektronische bediening en mechanische keerkoppeling zonder TRIM	B	1.511,57	1829,00	
	EC4UEM1	Schakelkast voor elektronische bediening en mechanische keerkoppeling zonder TRIM	B	1.511,57	1829,00	
	EC312EMT1	Schakelkast voor elektronische bediening en mechanische keerkoppeling met TRIM	B	1.817,36	2199,00	
	EC4EMT1	Schakelkast voor elektronische bediening en mechanische keerkoppeling met TRIM	B	1.817,36	2199,00	
	EC3E3U	Universele elektronische gaskabel L=3M	B	56,20	68,00	
	EC3E3M	Elektronische gaskabel voor VF motor L=3M	B	80,99	98,00	
	EC3E3MD	Elektronische gaskabel voor VD motor L=3M	B	57,85	70,00	
Nieuw!	ECG3/6	Schakelkabel 3M 6 draads	ST	82,64	100,00	
Nieuw!	ECG5/6	Schakelkabel 5M 6 draads	ST	97,52	118,00	
Nieuw!	ECG7/6	Schakelkabel 7M 6 draads	ST	80,99	98,00	
	EC3T3	Trim/trolling kabel L=3M	B	57,85	70,00	
	EC3TM	Trim/trolling kabel L=3M	B	57,85	70,00	
	EC3T3MM	Elektrische kabel regelkast - Mercruiser TRIM, L = 3 mt	B	139,67	169,00	











TYPE ECS

52	ECSH1	ECS bedieningshendel 1 motor	K	1.693,39	2049,00	
	ECSH2	ECS bedieningshendel 2 motoren	K	1.693,39	2049,00	
	ECSCU	ECS Control unit	K	693,39	839,00	
	ECSSWH	ECS enkele kabelboom	K	561,16	679,00	
	ECSTWH	ECS dubbele kabelboom	K	941,32	1139,00	
	ECSA12	ECS actuator 12VDC	K	619,01	749,00	
	ECSA24	ECS actuator 24VDC	K	676,86	819,00	
	CABL15	Trek-/drukkabel type LF (Low Friction), lengte 1,5 m	C	56,20	68,00	
	CABL20	Trek-/drukkabel type LF (Low Friction), lengte 2,0 m	C	57,02	69,00	
	KOGELGEWR	Kogelgewricht voor kabels type 33 en LF	C	9,88	11,95	
	KABELKL	Kabelklem voor kabels type 33 en LF	C	5,74	6,95	
	ECSPC5	ECS voedingskabel 5m	K	40,45	48,95	
	ECSPC10	ECS voedingskabel 10m	K	69,42	84,00	
	ECSBC01	ECS bus kabel (hendel en aandrijving) 1m	K	91,74	111,00	
	ECSBC05	ECS bus kabel (hendel en aandrijving) 5m	K	100,83	122,00	
	ECSBC10	ECS bus kabel (hendel en aandrijving) 10m	K	119,01	144,00	
	ECSBC15	ECS bus kabel (hendel en aandrijving) 15m	K	135,54	164,00	
	ECSBC20	ECS bus kabel (hendel en aandrijving) 20m	K	159,50	193,00	
	ECSBC30	ECS bus kabel (hendel en aandrijving) 30m	K	194,21	235,00	
	ECSBCC	ECS Bus conversie kabel	K	47,11	57,00	
	ECSBTR	ECS bus afsluit weerstand	K	14,83	17,95	
	ECSGCM10	ECS koppeling kabel mechanisch. 10m	K	66,12	80,00	
	ECSGCSV05	ECS koppeling kabel geen connector. 5m	K	94,21	114,00	
	ECSGCSV10	ECS koppeling kabel elektrische klep 10m	K	109,92	133,00	
	ECSTC4210	ECS gas kabel 4-20mA 10m	K	63,64	77,00	
	ECSTC4220	ECS gas kabel 4-20mA 20m	K	100,00	121,00	
	ECSTC0510	ECS gas kabel 0-5V 10m	K	63,64	77,00	
	ECSTC0520	ECS gas kabel 0-5V 20m	K	100,00	121,00	
	ECSTCPW10	ECS gas kabel PWM 10m	K	63,64	77,00	
	ECSTCPW20	ECS gas kabel PWM 20m	K	100,00	121,00	
	ECSCS110	ECS hulp kabel start vergrendeling 10m	K	114,05	138,00	







	ECSCSIC10	ECS kabel start vergrendeling contact veiligheid stop, high stationair 10m	K	175,21	212,00
	ECSCAM10	ECS kabel alarm en monitor interface 10m	K	49,59	60,00
	ECSPCI20	ECS voedingskabel ontsteking 20m	K	85,95	104,00
	ECSTRPWM	ECS Trolling/PWM (alleen op speciaal verzoek)	B	891,74	1079,00

TREK-/DRUKKABELS TYPE 33C















	53	CABLF05	Trek-/drukkabel type LF (Low Friction), lengte 0,5 m	C	54,55	66,00
		CABLF075	Trek-/drukkabel type LF (Low Friction), lengte 0,75 m	C	56,20	68,00
		CABLF10	Trek-/drukkabel type LF (Low Friction), lengte 1,0 m	C	57,02	69,00
		CABLF15	Trek-/drukkabel type LF (Low Friction), lengte 1,5 m	C	56,20	68,00
		CABLF20	Trek-/drukkabel type LF (Low Friction), lengte 2,0 m	C	57,02	69,00
		CABLF25	Trek-/drukkabel type LF (Low Friction), lengte 2,5 m	C	61,98	75,00
		CABLF30	Trek-/drukkabel type LF (Low Friction), lengte 3,0 m	C	64,46	78,00
		CABLF35	Trek-/drukkabel type LF (Low Friction), lengte 3,5 m	C	66,94	81,00
		CABLF40	Trek-/drukkabel type LF (Low Friction), lengte 4,0 m	C	70,25	85,00
		CABLF45	Trek-/drukkabel type LF (Low Friction), lengte 4,5 m	C	71,90	87,00
		CABLF50	Trek-/drukkabel type LF (Low Friction), lengte 5,0 m	C	74,38	90,00
		CABLF55	Trek-/drukkabel type LF (Low Friction), lengte 5,5 m	C	75,21	91,00
		CABLF60	Trek-/drukkabel type LF (Low Friction), lengte 6,0 m	C	77,69	94,00
		CABLF65	Trek-/drukkabel type LF (Low Friction), lengte 6,5 m	C	80,17	97,00
		CABLF70	Trek-/drukkabel type LF (Low Friction), lengte 7,0 m	C	85,12	103,00
		CABLF75	Trek-/drukkabel type LF (Low Friction), lengte 7,5 m	C	87,60	106,00
		CABLF80	Trek-/drukkabel type LF (Low Friction), lengte 8,0 m	C	87,60	106,00
		CABLF85	Trek-/drukkabel type LF (Low Friction), lengte 8,5 m	C	90,08	109,00
		CABLF90	Trek-/drukkabel type LF (Low Friction), lengte 9,0 m	C	93,39	113,00
		CABLF95	Trek-/drukkabel type LF (Low Friction), lengte 9,5 m	C	94,21	114,00
		CABLF100	Trek-/drukkabel type LF (Low Friction), lengte 10,0 m	C	99,17	120,00
		CABLF105	Trek-/drukkabel type LF (Low Friction), lengte 10,5 m	C	106,61	129,00
		CABLF110	Trek-/drukkabel type LF (Low Friction), lengte 11 m	C	114,88	139,00
		CABLF120	Trek-/drukkabel type LF (Low Friction), lengte 12 m	C	128,10	155,00
		CABLF130	Trek-/drukkabel type LF (Low Friction), lengte 13 m	C	140,50	170,00
		CABLF140	Trek-/drukkabel type LF (Low Friction), lengte 14 m	C	146,28	177,00
		CABLF150	Trek-/drukkabel type LF (Low Friction), lengte 15 m	C	153,72	186,00
		CABLE05A	Kabel type 33C, 0,5 m	Q	23,10	27,95
		CABLE10A	Kabel type 33C, 1,0 m	Q	23,10	27,95
		CABLE15A	Kabel type 33C, 1,5 m	Q	24,75	29,95
		CABLE20A	Kabel type 33C, 2,0 m	Q	27,23	32,95
		CABLE25A	Kabel type 33C, 2,5 m	Q	28,88	34,95
		CABLE30A	Kabel type 33C, 3,0 m	Q	30,54	36,95
		CABLE35A	Kabel type 33C, 3,5 m	Q	31,36	37,95
		CABLE40A	Kabel type 33C, 4,0 m	Q	35,50	42,95
		CABLE45A	Kabel type 33C, 4,5 m	Q	36,32	43,95
		CABLE50A	Kabel type 33C, 5,0 m	Q	38,80	46,95
		KABELKL	Kabelklem voor kabels type 33 en LF	C	5,74	6,95
		KOGELGEWR	Kogelgewricht voor kabels type 33 en LF	C	9,88	11,95
		DC	Stopknop type DC	B	38,80	46,95
		DSKITF	Differentiaal-apparaat voor brandstofpomp	B	33,02	39,95
		DS	Differentiaal-apparaat voor keerkoppeling	B	101,65	123,00

MOTOR TRILLINGSDEMPERS

	54	KSTEUN25V	Trillingdemper type K25V	B	57,85	70,00
		KSTEUN35V	Trillingdemper type K35V	B	57,85	70,00
		KSTEUN40A	Trillingdemper type K40A	B	57,85	70,00
		KSTEUN50V	Trillingdemper type K50V	B	57,85	70,00
		KSTEUN75V	Trillingdemper type K75V	B	57,85	70,00
		KSTEUN80V	Trillingdemper type K80V	B	57,85	70,00
		KSTEUN100V	Trillingdemper type K100V	B	57,85	70,00
	55	MITSTEUN	Hydro trillingdemper	B	181,82	220,00
		HY100	Trillingdemper type HY100	B	85,12	103,00
		HY150	Trillingdemper type HY150	B	85,12	103,00
		HY230	Trillingdemper type HY230	B	85,12	103,00
		LMX140	Trillingdemper type LMX 140	B	163,64	198,00
		LMX210	Trillingdemper type LMX 210	B	163,64	198,00
		LMX340	Trillingdemper type LMX 340	B	183,47	222,00
		LMX500	Trillingdemper type LMX 500	B	183,47	222,00

KOELWATERFILTERS

56	FTR140/13	Koelwaterfilter type 140, slangaansluiting Ø 12,7 mm	C	88,43	107,00	
	FTR140/16	Koelwaterfilter type 140, slangaansluiting Ø 15,9 mm	C	88,43	107,00	
	FTR140/19	Koelwaterfilter type 140, slangaansluiting Ø 19,1 mm	C	88,43	107,00	
Nieuw!	FTR140FM	Fijnmazig metaalfilterelement geschikt voor de FTR140/..	C	18,97	22,95	
	FILTER150	Koelwaterfilter type 150, slangaansluiting Ø 28,5 mm	C	44,63	54,00	
57	FTR330/13	Koelwaterfilter type 330, slangaansluitingen Ø 12,7 mm	C	106,61	129,00	
	FTR330/16	Koelwaterfilter type 330, slangaansluitingen Ø 15,9 mm	C	106,61	129,00	
	FTR330/19	Koelwaterfilter type 330, slangaansluitingen Ø 19,1 mm	C	106,61	129,00	
	FTR330/25	Koelwaterfilter type 330, slangaansluitingen Ø 25,4 mm	C	106,61	129,00	
	FTR330/32	Koelwaterfilter type 330, slangaansluitingen Ø 31,8 mm	C	106,61	129,00	
	FTR330/38	Koelwaterfilter type 330, slangaansluitingen Ø 38,0 mm	C	106,61	129,00	
	FTR470/13	Koelwaterfilter type 470-12,7 mm	C	108,26	131,00	
	FTR470/16	Koelwaterfilter type 470-15,9 mm	C	108,26	131,00	
	FTR470/19	Koelwaterfilter type 470-19,1 mm	C	108,26	131,00	
	FTR470/25	Koelwaterfilter type 470-25,4 mm	C	108,26	131,00	
	FTR470/32	Koelwaterfilter type 470-31,8 mm	C	108,26	131,00	
	FTR470/38	Koelwaterfilter type 470-38,1 mm	C	108,26	131,00	
	FTR132038	Koelwaterfilter type 1320, G 1½ voor slang Ø 38 mm	C	296,69	359,00	
	FTR132050	Koelwaterfilter type 1320, G 2 voor slang Ø 50 mm	C	296,69	359,00	
	FTR132063	Koelwaterfilter type 1320, G 2½ voor slang Ø 63 mm	C	296,69	359,00	
58	FTR190063	Koelwaterfilter type 1900, G 2½ (geschikt voor slang Ø 63 mm)	A	519,83	629,00	
	FTR190076	Koelwaterfilter type 1900, G 3 (geschikt voor slang Ø 76 mm)	A	519,83	629,00	
	FTR33019M	Koelwaterfilter type 330 met aluminium deksel, slangaansluitingen Ø 19,0 mm	C	201,65	244,00	
	FTR33025M	Koelwaterfilter type 330 met aluminium deksel, slangaansluitingen Ø 25,0 mm	C	201,65	244,00	
	FTR33032M	Koelwaterfilter type 330 met aluminium deksel, slangaansluitingen Ø 32,0 mm	C	201,65	244,00	
	FTR33038M	Koelwaterfilter type 330 met aluminium deksel, slangaansluitingen Ø 38,0 mm	C	201,65	244,00	
59	CWS1	Koelwaterfilter met 1 inch aansluiting	A	329,75	399,00	
	CWS11/4	Koelwaterfilter met 1 1/4 inch aansluiting	A	329,75	399,00	
	CWS11/2	Koelwaterfilter met 1 1/2 inch aansluiting	A	329,75	399,00	
	Nieuw! CWSCSET	Koelwaterfilter afdekking binnenzijde (set)	ST	26,40	31,95	
	FTR525	Koelwaterfilter uit RVS 316, type 525, G 1½ voor slang Ø 38 mm	A	693,39	839,00	
60	WKIT33013	Waterfilterset 330 - 13 mm (zonder filter)	C	69,42	84,00	
	WKIT33016	Waterfilterset 330 - 16 mm (zonder filter)	C	61,16	74,00	
	WKIT33019	Waterfilterset 330 - 19 mm (zonder filter)	C	98,35	119,00	
	WKIT33025	Waterfilterset 330 - 25 mm (zonder filter)	C	114,05	138,00	
	WKIT33032	Waterfilterset 330 - 32 mm (zonder filter)	C	164,46	199,00	
	WKIT33038	Waterfilterset 330 - 38 mm (zonder filter)	C	157,85	191,00	
	BKIT33013	Waterfilterset type 330, 13 mm aansluiting, in brons	C	82,64	100,00	
	BKIT33019	Waterfilterset type 330, 19 mm aansluiting, in brons	C	101,65	123,00	
	BKIT33025	Waterfilterset type 330, 25 mm aansluiting, in brons	C	111,57	135,00	
	BKIT33032	Waterfilterset type 330, 32 mm aansluiting, in brons	C	177,69	215,00	
	BKIT33038	Waterfilterset type 330, 38 mm aansluiting, in brons	C	190,08	230,00	
	CONN330	Koppelkit voor twee FTR330/32 filters(zonder waterfilters)	C	114,88	139,00	
	BISEP19	Lenswater-olie afscheider 19 mm. slangaansluiting	C	130,58	158,00	
	BISEP19F2	Reserve filterelement voor lenswater-olie afscheider BISEP19, set van 15 stuks	C	27,23	32,95	
	61	FIREPORTB	Fireport voor motorkamer met zwarte afwerkrand	C	33,02	
MWHOSE19		Koelwaterslang inw. Ø 19 mm. (Rol van 20 meter, Prijs per meter)	C	30,54	36,95	
MWHOSE25		Koelwaterslang inw. Ø 25 mm. (Rol van 20 meter, Prijs per meter)	C	33,02	39,95	
MWHOSE32		Koelwaterslang inw. Ø 32 mm. (Rol van 20 meter, Prijs per meter)	C	37,98	45,95	
MWHOSE38		Koelwaterslang inw. Ø 38 mm. (Rol van 20 meter, Prijs per meter)	C	43,80	53,00	
MWHOSE51		Koelwaterslang inw. Ø 51 mm. (Rol van 20 meter, Prijs per meter)	C	54,55	66,00	
ISOLATIEMATERIAAL						
62	ST020A	Geluidisolatie 20 mm Sonitech, Aluminium (600 x 1000 mm)	B	31,36	37,95	
	ST040A	Geluidisolatie 40 mm Sonitech, Aluminium (600 x 1000 mm)	B	40,45	48,95	
	ST020W	Geluidisolatie 20 mm Sonitech, Wit (600 x 1000 mm)	B	30,54	36,95	
	ST040W	Geluidisolatie 40 mm Sonitech, Wit (600 x 1000 mm)	B	40,45	48,95	
	ST135A	Geluidisolatie 35 mm Sonitech single, Aluminium (600 x 1000 mm)	B	56,20	68,00	
	ST145A	Geluidisolatie 45 mm Sonitech single, Aluminium (600 x 1000 mm)	B	61,16	74,00	

	ST135W	Geluidisolatie 35 mm Sonitech single, wit (600 x 1000 mm)	B	65,29	79,00
	ST145W	Geluidisolatie 45 mm Sonitech single, wit (600 x 1000 mm)	B	68,60	83,00
	PT112A	Geluidisolatie 12 mm Prometech single, Aluminium (600 x 1000 mm)	B	54,55	66,00
	PT135A	Geluidisolatie 35 mm Prometech single, Aluminium (600 x 1000 mm)	B	75,21	91,00
	PT145A	Geluidisolatie 45 mm Prometech single, Aluminium (600 x 1000 mm)	B	82,64	100,00
	PT112W	Geluidisolatie 12 mm Prometech single, wit (600 x 1000 mm)	B	61,98	75,00
	PT135W	Geluidisolatie 35 mm Prometech single, wit (600 x 1000 mm)	B	84,30	102,00
	PT145W	Geluidisolatie 45 mm Prometech single, wit (600 x 1000 mm)	B	94,21	114,00
	PT225S	Geluidisolatie 30 mm Prometech double, zilver	B	113,22	137,00
	PT245S	Geluidisolatie 45 mm Prometech double, zilver	B	128,10	155,00
	PT260S	Geluidisolatie 60 mm Prometech double, zilver	B	162,81	197,00
	PT225W	Geluidisolatie 30 mm Prometech double, wit	B	113,22	137,00
	PT245W	Geluidisolatie 45 mm Prometech double, wit	B	128,10	155,00
	PT260W	Geluidisolatie 60 mm Prometech double, wit	B	143,80	174,00
	64 GF140S	Geluidpendende glaswol plaat 1200 x 800 x 40 mm, met alu afdeklaag(prijs per plaat)	B	230,58	279,00
	PU130S	Geluidpendende pu-schuim platen, 4 stuks van 500 x 1000 x 30 mm met alu afdeklaag	B	137,19	166,00
	65 ARM10X12	Ontdreuningsplaat, 1000 x 1200 x 4 mm (prijs per plaat)	B	41,32	50,00
	TAPEG30	Zelfklevende afwerktape, grijs, per rol van 30 meter	B	14,83	17,95
	TAPEW30	Zelfklevende afwerktape, wit, per rol van 30 meter	B	14,83	17,95
	TAPEA30	Zelfklevende afwerktape, aluminium, per rol van 30 meter	B	16,49	19,95
	TAPEGF50	Zelfklevende afwerktape, glasvezel, per rol van 50 meter	B	95,04	115,00
	66 FIXP	Bevestigingsrozetten voor geluidpendende plaat (per 15 stuk)	B	14,83	17,95
	MBSET01	Montagebeugelset A, M5 x 35, geschikt voor ASD	C	31,36	37,95
	MBSET02	Montagebeugelset A, geschikt voor ASDV/H & AIRVENTV/H	C	27,23	32,95
	MBSET03	Montagebeugelset A, geschikt voor FTR140, WS180, WS270 & NSFS	C	27,23	32,95
	MBSET04	Montagebeugelset A, M6 x 35, geschikt voor VT7	C	20,62	24,95
	MBSET05	Montagebeugelset A, geschikt voor FTR330, FILTER150 & NSF	C	31,36	37,95
ELEKTRISCH VOORSTUWING					
	70 ELINE050	E-LINE elektrische voorstuwing, inboard, 5kW 48V, vloeistof gekoeld. Vermogen in Normale stand max. 5,6kW	EP	4.709,92	5699,00
	ELINE075	E-LINE elektrische voorstuwing, inboard, 7,5kW 48V, vloeistof gekoeld. Vermogen in Normale stand max. 8,4kW	EP	5.288,43	6399,00
	ELINE100	E-LINE elektrische voorstuwing, inboard, 10kW 48V, vloeistof gekoeld. Vermogen in Normale stand max. 11,3kW	EP	6.197,52	7499,00
	EPOD100	E-POD elektrische voorstuwing, 10kW alles-in-een plug&play set. 48V, max. Vermogen max. 11,3kW	EPO	8.676,86	10499,00
MOTORPANELEN					
	72 MPE1KB	V-CAN paneel voor elektrische voortstuwing met sleutel, zwart	EP	197,52	239,00
	MPE1MB	V-CAN paneel voor elektrische voortstuwing, zwart	EP	222,31	269,00
	76 EIP12	Elektrische impeller pomp 12V	A	140,50	170,00
	ELPS	Bediening voor elektrische voortstuwing, zijmontage, V-CAN	EP	693,39	839,00
V-CAN KABELS					
	77 CANNME7	Multifunctioneel display voor elektrische voorstuwing, 7" scherm, NMEA2000	EP	1.304,96	1579,00
	CANV2N1	CANverter 1-richting van V-CAN naar NMEA2000	A	222,31	269,00
Nieuw!	CANNS500	Digital Battery Monitoring Shunt NMEA2000 and WiFi connection, max. current 500A	EP	255,37	309,00
	CANNPSCM	NMEA2000 Stroomvoorziening met stekker, 3A zekering, 1 meter kabel	A	18,97	22,95
	CANNCO1	NMEA2000 kabel stekker en contrastekker, 1 meter	A	23,93	28,95
	CANNCO2	NMEA2000 kabel stekker en contrastekker, 2 meter	A	34,67	41,95
	CANNCO5	NMEA2000 kabel stekker en contrastekker, 5 meter	A	69,42	84,00
	CANNCO10	NMEA2000 kabel stekker en contrastekker, 10 meter	A	113,22	137,00
Nieuw!	DTCAN3M	CAN-bus datakabel 3 m	A	45,45	55,00
Nieuw!	DTCAN5M	CAN-bus datakabel 5 m	A	57,85	70,00
Nieuw!	DTCAN7,5M	CAN-bus datakabel 7,5 m	A	75,21	91,00
Nieuw!	DTCAN10M	CAN-bus datakabel 10 m	A	95,87	116,00
Nieuw!	DTCAN15M	CAN-bus datakabel 15 m	A	140,50	170,00
Nieuw!	DTCAN30M	CAN-bus datakabel 30 m	A	263,64	319,00
	CANNHUB	NMEA2000 drieweg hub stekker-contrastekker-stekker	A	39,63	47,95
	CANNTF	NMEA2000 afsluitweerstand contrastekker - 120 Ohm	A	10,70	12,95
	CANNTM	NMEA2000 afsluitweerstand stekker - 120 Ohm	A	10,70	12,95

SCHROEFASSYSTEMEN

FLEXIBELE KOPPELING TYPE COMBIFLEX

85	COMFL1225	Flexibele koppeling type Combiflex 12, as Ø 25 mm	A	288,43	349,00
	COMFL1230	Flexibele koppeling type Combiflex 12, as Ø 30 mm	A	288,43	349,00
	COMFL1325	Flexibele koppeling type Combiflex 13, as Ø 25 mm	A	288,43	349,00
	COMFL1330	Flexibele koppeling type Combiflex 13, as Ø 30 mm	A	288,43	349,00

FLEXIBELE KOPPELING TYPE 6

	KO51	Type 6, asgat Ø 25 mm	A	288,43	349,00
	KO52	Type 6, asgat Ø 30 mm	A	288,43	349,00
	KO53	Type 6, asgat Ø 35 mm	A	288,43	349,00
	KO54	Type 6, Ø 20 mm voorgeboord	A	247,11	299,00

FLEXIBELE KOPPELING TYPE UNIFLEX

	UNIFL1320	Type Uniflex 13, voor asdiameter Ø 20 mm	A	354,55	429,00
	UNIFL1325	Type Uniflex 13, voor asdiameter Ø 25 mm	A	461,98	559,00
	UNIFL1330	Type Uniflex 13 voor asdiameter Ø 30 mm	A	461,98	559,00
	UNIFL1630	Type Uniflex 16, voor asdiameter Ø 30 mm	A	709,92	859,00
	UNIFL1635	Type Uniflex 16, voor asdiameter Ø 35 mm	A	709,92	859,00
	UNIFL1640	Type Uniflex 16, voor asdiameter Ø 40 mm	A	709,92	859,00
	SET64	Set bouten voor koppeling type 6, voor flens 4"	A	10,70	12,95
	SET65	Set bouten voor koppeling type 6, voor flens 5"	A	22,27	26,95
	UNISET4/5	Set tapeinden voor Uniflex 12 -13 -16 en Bullflex 1 - 8, aansluiting 4" en 5"	A	18,14	21,95

FLEXIBELE KOPPELING TYPE BULLFLEX, ASDIAMETER IN mm

86	BULFL011	Type Bullflex 1, voor asdiameter Ø 1"	A	379,34	459,00
	BULFL021	Type Bullflex 2, voor asdiameter Ø 1"	A	395,87	479,00
	BULFL041	Type Bullflex 4, voor asdiameter Ø 1"	A	470,25	569,00
	BULFL0814	Type Bullflex 8, voor asdiameter Ø 1¼"	A	800,83	969,00
	BULFL0812	Type Bullflex 8, voor asdiameter Ø 1½"	A	800,83	969,00
	BULFL1212	Type Bullflex 12, voor asdiameter Ø 1½"	A	1.090,08	1319,00
	BULFL1213	Type Bullflex 12, voor asdiameter Ø 1¾"	A	1.090,08	1319,00
	BULFL1612	Type Bullflex 16, voor asdiameter Ø 1½"	A	1.197,52	1449,00
	BULFL1613	Type Bullflex 16, voor asdiameter Ø 1¾"	A	1.197,52	1449,00
	BULFL162	Type Bullflex 16, voor asdiameter Ø 2"	A	1.197,52	1449,00
	BULFL3213	Type Bullflex 32, voor asdiameter Ø 1¾"	A	1.858,68	2249,00
	BULFL322	Type Bullflex 32, voor asdiameter Ø 2"	A	1.858,68	2249,00

FLEXIBELE KOPPELING TYPE BULLFLEX, ASDIAMETER IN INCHES

87	BULFL0120	Type Bullflex 1, voor asdiameter Ø 20 mm	A	387,60	469,00
	BULFL0125	Type Bullflex 1, voor asdiameter Ø 25 mm	A	387,60	469,00
	BULFL0220	Type Bullflex 2, voor asdiameter Ø 20 mm	A	395,87	479,00
	BULFL0225	Type Bullflex 2, voor asdiameter Ø 25 mm	A	395,87	479,00
	BULFL0425	Type Bullflex 4, voor asdiameter Ø 25 mm	A	495,04	599,00
	BULFL0430	Type Bullflex 4, voor asdiameter Ø 30 mm	A	495,04	599,00
	BULFL0830	Type Bullflex 8, voor asdiameter Ø 30 mm	A	742,98	899,00
	BULFL0835	Type Bullflex 8, voor asdiameter Ø 35 mm	A	742,98	899,00
	BULFL0840	Type Bullflex 8, voor asdiameter Ø 40 mm	A	742,98	899,00
	BULFL1235	Type Bullflex 12, voor asdiameter Ø 35 mm	A	858,68	1039,00
	BULFL1240	Type Bullflex 12, voor asdiameter Ø 40 mm	A	858,68	1039,00
	BULFL1245	Type Bullflex 12, voor asdiameter Ø 45 mm	A	858,68	1039,00
	BULFL1640	Type Bullflex 16, voor asdiameter Ø 40 mm	A	1.048,76	1269,00
	BULFL1645	Type Bullflex 16, voor asdiameter Ø 45 mm	A	1.048,76	1269,00
	BULFL1650	Type Bullflex 16, voor asdiameter Ø 50 mm	A	1.048,76	1269,00
	BULFL3245	Type Bullflex 32, voor asdiameter Ø 45 mm	A	1.900,00	2299,00
	BULFL3250	Type Bullflex 32, voor asdiameter Ø 50 mm	A	1.900,00	2299,00
	BULFL3260	Type Bullflex 32, voor asdiameter Ø 60 mm	A	1.900,00	2299,00
	BULFL3270	Type Bullflex 32, voor asdiameter Ø 70 mm	A	1.900,00	2299,00
	BUL16SET	Set tapeinden voor Bullflex type 12 en 16	A	64,46	78,00
	BUL32SET	Set tapeinden voor Bullflex type 32	A	23,10	27,95
	TMCSET	Set tapeinden voor Uniflex/Bullflex en Technodrive keerkoppeling	A	7,81	9,45
	UNISET4/5	Set tapeinden voor Uniflex 12 -13 -16 en Bullflex 1 - 8, aansluiting 4" en 5"	A	18,14	21,95

HOMOKINEET MET INGEBOUWD DRUKLAGER

88	VDR210254	Type 2, As 25, homokineet 10, 4"	K	1.255,37	1519,00
	VDR210255	Type 2, As 25, homokineet 10, 5"	K	1.313,22	1589,00



	VDR210304	Type 2, As 30, homokineet 10, 4"	K	1.255,37	1519,00	
	VDR210305	Type 2, As 30, homokineet 10, 5"	K	1.313,22	1589,00	
	VDR215254	Type 2, As 25, homokineet 15, 4"	K	1.445,45	1749,00	
	VDR215255	Type 2, As 25, homokineet 15, 5"	K	1.453,72	1759,00	
	VDR215304	Type 2, As 30, homokineet 15, 4"	K	1.445,45	1749,00	
	VDR215305	Type 2, As 30, homokineet 15, 5"	K	1.453,72	1759,00	
	VDR215354	Type 2, As 35, homokineet 15, 4"	K	1.511,57	1829,00	
	VDR215355	Type 2, As 35, homokineet 15, 5"	K	1.519,83	1839,00	
	VDR221304	Type 2, As 30, homokineet 21, 4"	K	2.065,29	2499,00	
	VDR221305	Type 2, As 30, homokineet 21, 5"	K	2.354,55	2849,00	
	VDR221354	Type 2, As 35, homokineet 21, 4"	K	2.106,61	2549,00	
	VDR221355	Type 2, As 35, homokineet 21, 5"	K	2.106,61	2549,00	
Nieuw!	VDR421355	Type 4, As 35, homokineet 21, 5"	K	2.933,06	3549,00	
	VDR221404	Type 2, As 40, homokineet 21, 4"	K	2.106,61	2549,00	
	VDR221405	Type 2, As 40, homokineet 21, 5"	K	2.106,61	2549,00	
	VDR421404	Type 4, As 40, homokineet 21, 4"	K	3.180,99	3849,00	
	VDR421405	Type 4, As 40, homokineet 21, 5"	K	3.180,99	3849,00	
	VDR421454	Type 4, As 45, homokineet 21, 4"	K	3.222,31	3899,00	
	VDR421455	Type 4, As 45, homokineet 21, 5"	K	3.222,31	3899,00	
	VDR421505	Type 4, As 50, homokineet 21, 5"	K	3.222,31	3899,00	
	VDR430404	Type 4, As 50, homokineet 40, 4"	K	6.032,23	7299,00	
	VDR430405	Type 4, As 50, homokineet 40, 5"	K	6.032,23	7299,00	
	VDR430454	Type 4, As 50, homokineet 45, 4"	K	6.032,23	7299,00	
	VDR430455	Type 4, As 50, homokineet 45, 5"	K	6.032,23	7299,00	
	VDR430504	Type 4, As 50, homokineet 30, 4"	K	5.908,26	7149,00	
	VDR430505	Type 4, As 50, homokineet 30, 5"	K	5.990,91	7249,00	
	VDR630505	Type 6, As 50, homokineet 30, 5"	K	8.015,70	9699,00	
	VDR630605	Type 6, As 60, homokineet 30, 5"	K	8.718,18	10549,00	
	VDR630705	Type 6, As 70, homokineet 30, 5"	K	8.842,15	10699,00	
	VDR630506	Type 6, As 50, homokineet 30, 6"	K	8.718,18	10549,00	
	VDR630606	Type 6, As 60, homokineet 30, 5"	K	8.842,15	10699,00	
	VDR630706	Type 6, As 70, homokineet 30, 6"	K	8.883,47	10749,00	
	VDR642505	Type 6, As 50, homokineet 42, 5"	K	13.098,35	15849,00	
	VDR642605	Type 6, As 50, homokineet 42, 6"	K	13.263,64	16049,00	
	VDR642705	Type 6, As 70, homokineet 42, 5"	K	9.296,69	11249,00	
	VDR642506	Type 6, As 50, homokineet 42, 6"	K	13.180,99	15949,00	
	VDR642606	Type 6, As 60, homokineet 42, 6"	K	13.304,96	16099,00	
	VDR642706	Type 6, As 70, homokineet 42, 6"	K	13.470,25	16299,00	
	89	FLANGE1	Tussenflens voor Yanmar KM2C; KMP2P; KM3P, Kanzaki KC30; KC45 en KC100	A	98,35	119,00
		FLANGE2	Tussenflens voor Volvo MS10A/L; MS15A/L en MS25A/L	A	86,78	105,00
		FLANGE2A	Tussenflens boordenknoop voor Volvo MS; MSB en alle types MS2	A	148,76	180,00
		FLANGE3	Tussenflens voor Yanmar KM4A; KM4A1; KMH4A; KBW20-1; KBW21 en Kanzaki KC180	A	148,76	180,00

SCHROEFASINSTALLATIES

RVS SCHROEFASSEN UIT REMANIT 4462

90	SA25/1000	Schroefas met dopmoer en zinkanode Ø 25 mm. lengte 1000 mm	A	238,84	289,00
	SA25/+	Meerprijs per 500 mm	A	65,29	79,00
	SA30/1000	Schroefas met dopmoer en zinkanode Ø 30 mm. lengte 1000 mm	A	313,22	379,00
	SA30/+	Meerprijs per 500 mm	A	90,91	110,00
	SA35/1000	Schroefas met dopmoer en zinkanode Ø 35 mm. lengte 1000 mm	A	420,66	509,00
	SA35/+	Meerprijs per 500 mm	A	112,40	136,00
	SA40/1000	Schroefas met dopmoer en zinkanode Ø 40 mm. lengte 1000 mm	A	561,16	679,00
	SA40/+	Meerprijs per 500 mm	A	156,20	189,00
	SA45/1000	Schroefas met dopmoer en zinkanode Ø 45 mm. lengte 1000 mm	A	676,86	819,00
	SA45/+	Meerprijs per 500 mm	A	185,12	224,00
	SA50/1000	Schroefas met dopmoer en zinkanode Ø 50 mm. lengte 1000 mm	A	809,09	979,00
	SA50/+	Meerprijs per 500 mm	A	238,84	289,00
	SA60/1000	Schroefas met dopmoer en zinkanode Ø 60 mm. lengte 1000 mm	A		Prijs op aanvraag
	SA60/+	Meerprijs per 500 mm	A		Prijs op aanvraag

BELANGRIJK:

Gezien de sterk fluctuerende wereld-markt prijzen van RVS kunnen aan bovengenoemde prijzen voor schroefassen geen rechten worden ontleend.

SCHROEFASAFDICHTINGEN VOOR BRONZEN, STALEN EN POLYESTER SCHROEFASKOKERS

ZWB25I	Schroefasafdichting, brons zwevend Ø 25 mm, met tweevoudige lipafdichting	A	222,31	269,00	
ZWB30I	Schroefasafdichting, brons zwevend Ø 30 mm, met tweevoudige lipafdichting	A	437,19	529,00	
ZWB35A	Schroefasafdichting, brons zwevend Ø 35 mm, met tweevoudige lipafdichting	A	238,84	289,00	
ZWB40A	Schroefasafdichting, brons zwevend Ø 40 mm, met tweevoudige lipafdichting	A	271,90	329,00	
ZWB45A	Schroefasafdichting, brons zwevend Ø 45 mm, met tweevoudige lipafdichting	A	313,22	379,00	
ZWB50A	Schroefasafdichting, brons zwevend Ø 50 mm, met tweevoudige lipafdichting	A	321,49	389,00	
ZWB60	Schroefasafdichting, brons zwevend Ø 60 mm, met tweevoudige lipafdichting	A	387,60	469,00	



Tweevoudige lipseals als vervanging van stopbuspakking

ZWB2540	Vervangingsset voor 25 mm zwevend lager met stopbuspakking	A	247,11	299,00	
ZWB3044	Vervangingsset voor 30 mm zwevend lager met stopbuspakking	A	157,02	190,00	



Zelf uitlijnende lager met driedubbele Schroefasafdichting

91	ZWBH25	Flexibele Schroefasafdichting met 3-voudige lip 25 mm	A	83,47	101,00	
	ZWBH30	Flexibele Schroefasafdichting met 3-voudige lip 30 mm	A	94,21	114,00	
	ZWBH35	Flexibele Schroefasafdichting met 3-voudige lip 35 mm	A	104,96	127,00	





WATERSCHEPSET VOOR BRONZEN, STALEN EN POLYESTER KOKERS

WCAPSET	Waterschepset voor Ø 25-30-35 mm Schroefassen	A	41,28	49,95	
WCAPS1/2	Waterschepset voor Ø 40-45-50 mm Schroefassen	A	48,76	59,00	
ZWBKIT	Complete set voor conversie naar watergesmeerde Schroefas	A	14,83	17,95	



MONTAGEFLENZEN VOOR BRONZEN SCHROEFASKOKERS

FLK25	Montageflens voor Schroefaskoker Ø 25 mm.	A	47,93	58,00	
FLK30	Montageflens voor Schroefaskoker Ø 30 mm.	A	55,37	67,00	
	Grotere maten worden standaard meegeleverd met de Schroefaskoker				
FLK35	Montageflens Schroefaskoker Ø 35 mm, type BL	A	84,30	102,00	
FLK40	Montageflens Schroefaskoker Ø 40 mm, type BL	A	89,26	108,00	
FLK45	Montageflens Schroefaskoker Ø 45 mm, type BL	A	94,21	114,00	
FLK50	Montageflens Schroefaskoker Ø 50 mm, type BL	A	162,81	197,00	
FLK60	Montageflens Schroefaskoker Ø 60 mm, type BL	A		Prijs op aanvraag	



BRONZEN SCHROEFASSYSTEMEN

		Voor toebehoren zie 'toebehoren Schroefassystemen' hieronder.				
92	BL25/500	Schroefaskoker brons en buitenlager met rubberlager Ø 25 mm, lengte 500 mm.	A	321,49	389,00	
	BL25/+	Meerprijs per 500 mm	A	39,63	47,95	
	BL30/500	Schroefaskoker brons en buitenlager met rubberlager Ø 30 mm, lengte 500 mm.	A	412,40	499,00	
	BL30/+	Meerprijs per 500 mm	A	49,59	60,00	
	BL35/1000	Schroefaskoker, brons met rubberlager Ø 35 mm, lengte 1000 mm	A	718,18	869,00	
	BL35/+	Meerprijs per 500 mm	A	78,51	95,00	
	BL40/1000	Schroefaskoker, brons met rubberlager Ø 40 mm, lengte 1000 mm	A	792,56	959,00	
	BL40/+	Meerprijs per 500 mm	A	103,31	125,00	
	BL45/1000	Schroefaskoker, brons met rubberlager Ø 45 mm, lengte 1000 mm	A	1.073,55	1299,00	
	BL45/+	Meerprijs per 500 mm	A	110,74	134,00	
	BL50/1000	Schroefaskoker, brons met rubberlager Ø 50 mm, lengte 1000 mm	A	1.304,96	1579,00	
	BL50/+	Meerprijs per 500 mm	A	118,18	143,00	
	BL60/1000	Schroefaskoker, brons met rubberlager Ø 60 mm, lengte 1000 mm	A		Prijs op aanvraag	
	BL60/+	Meerprijs per 500 mm	A		Prijs op aanvraag	

VOORLAGERS VOOR BRONZEN, STALEN EN POLYESTER KOKERS

BR225	Voorlager voor Schroefaskoker Ø 25 mm	A	45,45	55,00	
BR230	Voorlager voor Schroefaskoker Ø 30 mm	A	46,28	56,00	
BR235	Voorlager voor Schroefaskoker Ø 35 mm	A	57,85	70,00	
BR240	Voorlager voor Schroefaskoker Ø 40 mm	A	61,98	75,00	
BR245	Voorlager voor Schroefaskoker Ø 45 mm	A	87,60	106,00	
BR250	Voorlager voor Schroefaskoker Ø 50 mm	A	99,17	120,00	
BR260	Voorlager voor Schroefaskoker Ø 60 mm	A		Prijs op aanvraag	

TUSSENLAGERS VOOR BRONZEN SCHROEFASKOKERS

BR325	Tussenlagers voor Schroefaskoker Ø 25 mm	A	98,35	119,00	
BR330	Tussenlagers voor Schroefaskoker Ø 30 mm	A	98,35	119,00	
BR335	Tussenlager voor Schroefaskoker Ø 35 mm	A	118,18	143,00	
BR340	Tussenlager voor Schroefaskoker Ø 40 mm	A	123,97	150,00	
BR345	Tussenlager voor Schroefaskoker Ø 45 mm	A	145,45	176,00	
BR350	Tussenlager voor Schroefaskoker Ø 50 mm	A	154,55	187,00	
BR360	Tussenlager voor Schroefaskoker Ø 60 mm	A		Prijs op aanvraag	

POLYESTER SCHROEFASSYSTEMEN

Voor toebehoren zie 'toebehoren schroefassystemen' hieronder.

93	BG25/0500	Glasvezelversterkt kunststof schroefaskoker met lager, Ø 25 mm, 500 mm lang	A	65,29	79,00
	BG25/+	Meerprijs per 500 mm (tot 2000 mm maximaal)	A	19,79	23,95
	BG30/0500	Schroefaskoker, polyester met rubberlager Ø 30 mm. lengte 500 mm.	A	80,17	97,00
	BG30/+	Meerprijs per 500 mm (tot 2000 mm maximaal)	A	23,10	27,95
	BG35/0500	Schroefaskoker, polyester met rubberlager Ø 35 mm. lengte 500 mm.	A	88,43	107,00
	BG35/+	Meerprijs per 500 mm (tot 2000 mm maximaal)	A	24,75	29,95
	BG40/0500	Schroefaskoker, polyester met rubberlager Ø 40 mm. lengte 500 mm.	A	100,00	121,00
	BG40/+	Meerprijs per 500 mm (tot 2000 mm maximaal)	A	26,40	31,95

VOORLAGERS VOOR BRONZEN, STALEN EN POLYESTER KOKERS

BR225	Voorlager voor schroefaskoker Ø 25 mm	A	45,45	55,00
BR230	Voorlager voor schroefaskoker Ø 30 mm	A	46,28	56,00
BR235	Voorlager voor schroefaskoker Ø 35 mm	A	57,85	70,00
BR240	Voorlager voor schroefaskoker Ø 40 mm	A	61,98	75,00

TUSSENLAGERS VOOR BRONZEN SCHROEFASKOKERS

BR325	Tussenlagers voor schroefaskoker Ø 25 mm	A	98,35	119,00
BR330	Tussenlagers voor schroefaskoker Ø 30 mm	A	98,35	119,00
BR335	Tussenlager voor schroefaskoker Ø 35 mm	A	118,18	143,00
BR340	Tussenlager voor schroefaskoker Ø 40 mm	A	123,97	150,00

SCHROEFASSYSTEMEN VOOR STALEN SCHEPEN

Voor toebehoren zie 'toebehoren schroefassystemen' hieronder.

94	BS25/0500	Stalen schroefaskoker met rubberlager Ø 25 mm, lengte 500 mm	A	167,77	203,00
	BS25/+	Meerprijs per 500 mm	A	39,63	47,95
	BS30/0500	Stalen schroefaskoker met rubberlager Ø 30 mm, lengte 500 mm	A	177,69	215,00
	BS30/+	Meerprijs per 500 mm	A	77,69	94,00
	BL35S1000	Stalen schroefaskoker met rubberlager Ø 35 mm, lengte 1000 mm	A	191,74	232,00
	BL35S/+	Meerprijs per 500 mm	A	32,19	38,95
	BL40S1000	Stalen schroefaskoker met rubberlager Ø 40 mm, lengte 1000 mm	A	204,96	248,00
	BL40S/+	Meerprijs per 500 mm	A	38,80	46,95
	BL45S1000	Stalen schroefaskoker met rubberlager Ø 45 mm, lengte 1000 mm	A	288,43	349,00
	BL45S/+	Meerprijs per 500 mm	A	45,45	55,00
	BL50S1000	Stalen schroefaskoker met rubberlager Ø 50 mm, lengte 1000 mm	A	362,81	439,00
	BL50S/+	Meerprijs per 500 mm	A	46,28	56,00
	BL60S1000	Stalen schroefaskoker met rubberlager Ø 60 mm, lengte 1000 mm	A		Prijs op aanvraag
	BL60S/+	Meerprijs per 500 mm	A		Prijs op aanvraag

VOORLAGERS VOOR BRONZEN, STALEN EN POLYESTER KOKERS

BR225	Voorlager voor schroefaskoker Ø 25 mm	A	45,45	55,00
BR230	Voorlager voor schroefaskoker Ø 30 mm	A	46,28	56,00
BR235	Voorlager voor schroefaskoker Ø 35 mm	A	57,85	70,00
BR240	Voorlager voor schroefaskoker Ø 40 mm	A	61,98	75,00
BR245	Voorlager voor schroefaskoker Ø 45 mm	A	87,60	106,00
BR250	Voorlager voor schroefaskoker Ø 50 mm	A	99,17	120,00
BR260	Voorlager voor schroefaskoker Ø 60 mm	A		Prijs op aanvraag

TUSSENLAGERS VOOR BRONZEN SCHROEFASKOKERS

BR325S	Tussenlagers voor schroefaskoker Ø 25 mm	A	109,09	132,00
BR330S	Tussenlagers voor schroefaskoker Ø 30 mm	A	114,88	139,00
BR335S	Tussenlager voor schroefaskoker Ø 35 mm	A	119,01	144,00
BR340S	Tussenlager voor schroefaskoker Ø 40 mm	A	125,62	152,00
BR345S	Tussenlager voor schroefaskoker Ø 45 mm	A	157,02	190,00
BR350S	Tussenlager voor schroefaskoker Ø 50 mm	A	162,81	197,00
BR360S	Tussenlager voor schroefaskoker Ø 60 mm	A		Prijs op aanvraag

SCHEEPSSCHROEVEN

3-BLADS SCHEEPSSCHROEVEN, TYPE P3B



97	P3B12X...	Type P3B, Ø12"	B	296,69	359,00
	P3B13X...	Type P3B, Ø13"	B	321,49	389,00
	P3B14X...	Type P3B, Ø14"	B	346,28	419,00
	P3B15X...	Type P3B, Ø15"	B	412,40	499,00
	P3B16X...	Type P3B, Ø16"	B	453,72	549,00
	P3B17X...	Type P3B, Ø17"	B	511,57	619,00

P3B18X...	Type P3B, Ø18"	B	561,16	679,00	
P3B19X...	Type P3B, Ø19"	B	619,01	749,00	
P3B20X...	Type P3B, Ø20"	B	660,33	799,00	
P3B21X...	Type P3B, Ø21"	B	776,03	939,00	
P3B22X...	Type P3B, Ø22"	B	916,53	1109,00	
P3B23X...	Type P3B, Ø23"	B	1.073,55	1299,00	
P3B24X...	Type P3B, Ø24"	B	1.205,79	1459,00	
P3B25X...	Type P3B, Ø25"	B	1.346,28	1629,00	



3-BLADS SCHEEPSSCHROEVEN, TYPE P3C

P3C12X...	Type P3C, Ø12"	B	379,34	459,00	
P3C13X...	Type P3C, Ø13"	B	387,60	469,00	
P3C14X...	Type P3C, Ø14"	B	420,66	509,00	
P3C15X...	Type P3C, Ø15"	B	461,98	559,00	
P3C16X...	Type P3C, Ø16"	B	528,10	639,00	
P3C17X...	Type P3C, Ø17"	B	610,74	739,00	
P3C18X...	Type P3C, Ø18"	B	660,33	799,00	
P3C19X...	Type P3C, Ø19"	B	751,24	909,00	
P3C20X...	Type P3C, Ø20"	B	858,68	1039,00	
P3C21X...	Type P3C, Ø21"	B	1.015,70	1229,00	
P3C22X...	Type P3C, Ø22"	B	1.172,73	1419,00	
P3C23X...	Type P3C, Ø23"	B	1.313,22	1589,00	
P3C24X...	Type P3C, Ø24"	B	1.478,51	1789,00	
P3C25X...	Type P3C, Ø25"	B	1.652,07	1999,00	

4-BLADS SCHEEPSSCHROEVEN, TYPE P4E





P4E14X...	Type P4E, Ø14"	B	544,63	659,00	
P4E15X...	Type P4E, Ø15"	B	594,21	719,00	
P4E16X...	Type P4E, Ø16"	B	619,01	749,00	
P4E17X...	Type P4E, Ø17"	B	685,12	829,00	
P4E18X...	Type P4E, Ø18"	B	809,09	979,00	
P4E19X...	Type P4E, Ø19"	B	924,79	1119,00	
P4E20X...	Type P4E, Ø20"	B	1.048,76	1269,00	
P4E21X...	Type P4E, Ø21"	B	1.156,20	1399,00	
P4E22X...	Type P4E, Ø22"	B	1.280,17	1549,00	
P4E23X...	Type P4E, Ø23"	B	1.437,19	1739,00	
P4E24X...	Type P4E, Ø24"	B	1.619,01	1959,00	

4-BLADS SCHEEPSSCHROEVEN, TYPE P4G

P4G16X..	Type P4G, Ø 16"	B	842,15	1019,00	
P4G17X..	Type P4G, Ø 17"	B	891,74	1079,00	
P4G18X..	Type P4G, Ø 18"	B	1.007,44	1219,00	
P4G19X..	Type P4G, Ø 19"	B	1.106,61	1339,00	
P4G20X..	Type P4G, Ø 20"	B	1.255,37	1519,00	
P4G21X..	Type P4G, Ø 21"	B	1.470,25	1779,00	
P4G22X..	Type P4G, Ø 22"	B	1.693,39	2049,00	
P4G23X..	Type P4G, Ø 23"	B	1.900,00	2299,00	
P4G24X..	Type P4G, Ø 24"	B	2.106,61	2549,00	
ASGAT20+	Nabewerken van asgat	B	167,77	203,00	

Specificeer a.u.b. de spoed en draairichting bij het bestellen

RESERVE ZINK ANODES

98	SN25B	Reserve zink anode voor Ø 25 mm asmoer	A	10,70	12,95	
	SN30B	Reserve zink anode voor Ø 30 mm schroefas	A	18,14	21,95	
	SN35B	Reserve zink anode voor Ø 35 mm asmoer	A	22,27	26,95	
	SN40B	Reserve zink anode voor Ø 40 mm asmoer	A	28,06	33,95	
	SN45B	Reserve zink anode voor Ø 45 mm asmoer	A	28,88	34,95	
	SN50B	Reserve zink anode voor Ø 50 mm asmoer	A	34,67	41,95	
	SN60B	Reserve zink anode voor Ø 60 mm asmoer	A	44,63	54,00	
	VRC25	Trossensnijder voor as Ø 25 mm	A	138,02	167,00	
	VRC30	Trossensnijder voor as Ø 30 mm	A	138,02	167,00	

RUBBERLAGERS

RUBBERLAGER MET ASMAAT IN mm EN BUITENMAAT IN INCHES

99	RULAGER20	Rubberlager voor as Ø 20 mm, buitenmaat Ø 1 ¼", lengte 76 mm, met messing huis	K	63,64	77,00
	RULAGER22	Rubberlager voor as Ø 22 mm, buitenmaat Ø 1 ¼", lengte 76 mm, met messing huis	K	63,64	77,00
	RULAGER25	Rubberlager voor as Ø 25 mm, buitenmaat Ø 1 ½", lengte 100 mm, met messing huis	B	28,88	34,95
	RULAGER30	Rubberlager voor as Ø 30 mm, buitenmaat Ø 1 ¾", lengte 120 mm, met messing huis	B	41,28	49,95
	RULAGER35	Rubberlager voor as Ø 35 mm, buitenmaat Ø 1 ¾", lengte 140 mm, met messing huis	B	46,28	56,00
	RULAGER40	Rubberlager voor as Ø 40 mm, buitenmaat Ø 2 ¼", lengte 160 mm, met messing huis	B	61,98	75,00
	RULAGER45	Rubberlager voor as Ø 45 mm, buitenmaat Ø 2 ¾", lengte 180 mm, met messing huis	B	83,47	101,00
	RULAGER50	Rubberlager voor as Ø 50 mm, buitenmaat Ø 2 ¾", lengte 200 mm, met messing huis	B	98,35	119,00
	RULAGER60	Rubberlager voor as Ø 60 mm, buitenmaat Ø 3", lengte 240 mm, met messing huis	B	173,55	210,00
	RULAGER65	Rubberlager voor as Ø 65 mm, buitenmaat Ø 3 ¾", lengte 260 mm, met messing huis	B	263,64	319,00
	RULAGER70	Rubberlager voor as Ø 70 mm, buitenmaat Ø 3 ½", lengte 280 mm, met messing huis	B	420,66	509,00
	RULAGER80	Rubberlager voor as Ø 80 mm, buitenmaat Ø 4", lengte 320 mm, met messing huis	B	428,93	519,00

RUBBERLAGER MET ASMAAT IN mm EN BUITENMAAT IN mm

	RL2540	Rubberlager voor as Ø 25 mm, buitenmaat Ø 40 mm, lengte 100 mm, met messing huis	B	34,67	41,95
	RL3045	Rubberlager voor as Ø 30 mm, buitenmaat Ø 45 mm, lengte 120 mm, met messing huis	B	41,28	49,95
	RL3550	Rubberlager voor as Ø 35 mm, buitenmaat Ø 50 mm, lengte 140 mm, met messing huis	B	57,85	70,00
	RL4055	Rubberlager voor as Ø 40 mm, buitenmaat Ø 55 mm, lengte 160 mm, met messing huis	B	100,83	122,00
	RL4565	Rubberlager voor as Ø 45 mm, buitenmaat Ø 65 mm, lengte 180 mm, met messing huis	B	138,02	167,00
	RL5070	Rubberlager voor as Ø 50 mm, buitenmaat Ø 70 mm, lengte 200 mm, met messing huis	B	156,20	189,00
	RL6080	Rubberlager voor as Ø 60 mm, buitenmaat Ø 80 mm, lengte 240 mm, met messing huis	B	197,52	239,00
	RL7090	Rubberlager voor as Ø 70 mm, buitenmaat Ø 90 mm, lengte 280 mm, met messing huis	B	255,37	309,00
	RL8010	Rubberlager voor as Ø 80 mm, buitenmaat Ø 100 mm, lengte 320 mm, met messing huis	B	346,28	419,00
	RL9011	Rubberlager voor as Ø 90 mm, buitenmaat Ø 110 mm, lengte 360 mm, met messing huis	B	511,57	619,00
	RL1012	Rubberlager voor as Ø100 mm, buitenmaat Ø 125 mm, lengte 400 mm, met messing huis	B	610,74	739,00
	RL2540PH	Rubberlager voor as Ø 25 mm, buitenmaat Ø 40 mm, lengte 100 mm, met kunststof huis	B	48,76	59,00
	RL3045PH	Rubberlager voor as Ø 30 mm, buitenmaat Ø 45 mm, lengte 120 mm, met kunststof huis	B	58,68	71,00
	RL3550PH	Rubberlager voor as Ø 35 mm, buitenmaat Ø 50 mm, lengte 140 mm, met kunststof huis	B	66,12	80,00
	RL4055PH	Rubberlager voor as Ø 40 mm, buitenmaat Ø 55 mm, lengte 160 mm, met kunststof huis	B	82,64	100,00
	RL4565PH	Rubberlager voor as Ø 45 mm, buitenmaat Ø 65 mm, lengte 180 mm, met kunststof huis	B	96,69	117,00
	RL5070PH	Rubberlager voor as Ø 50 mm, buitenmaat Ø 70 mm, lengte 200 mm, met kunststof huis	B	107,44	130,00
	RL6080PH	Rubberlager voor as Ø 60 mm, buitenmaat Ø 80 mm, lengte 240 mm, met kunststof huis	B	123,97	150,00
	RL7090PH	Rubberlager voor as Ø 70 mm, buitenmaat Ø 90 mm, lengte 280 mm, met kunststof huis	B	158,68	192,00
	RL8010PH	Rubberlager voor as Ø 80 mm, buitenmaat Ø 100 mm, lengte 320 mm, met kunststof huis	B	163,64	198,00
	RL9011PH	Rubberlager voor as Ø 90 mm, buitenmaat Ø 110 mm, lengte 360 mm, met kunststof huis	B	247,11	299,00
	RL1012PH	Rubberlager voor as Ø100 mm, buitenmaat Ø 125 mm, lengte 400 mm, met kunststof huis	B	346,28	419,00
	RL1PH	Rubberlager voor as Ø 1", buitenmaat 1 ½", lengte 4", met kunststof huis	B	52,89	64,00
	RL11/8PH	Rubberlager voor as Ø 1 ¼", buitenmaat 1 ¾", lengte 4 ½", met kunststof huis	B	190,08	230,00
	RL11/4PH	Rubberlager voor as Ø 1 ¼", buitenmaat 1 ¾", lengte 5", met kunststof huis	B	60,33	73,00
	RL13/8PH	Rubberlager voor as Ø 1 ¾", buitenmaat 1 ¾", lengte 5 ½", met kunststof huis	B	64,46	78,00
	RL11/2PH	Rubberlager voor as Ø 1 ½", buitenmaat 2", lengte 6", met kunststof huis	B	66,94	81,00
	RL13/4PH	Rubberlager voor as Ø 1 ¾", buitenmaat 2 ¾", lengte 7", met kunststof huis	B	80,17	97,00
	RL2PH	Rubberlager voor as Ø 2", buitenmaat 2 ¾", lengte 8", met kunststof huis	B	93,39	113,00
	RL21/4PH	Rubberlager voor as Ø 2 ¼", buitenmaat 3", lengte 9", met kunststof huis	B	100,83	122,00
	RL21/2PH	Rubberlager voor as Ø 2 ½", buitenmaat 3 ¼", lengte 10", met kunststof huis	B	119,83	145,00
	RL23/4PH	Rubberlager voor as Ø 2 ¾", buitenmaat 3 ¾", lengte 11", met kunststof huis	B	177,69	215,00
	RL3PH	Rubberlager voor as Ø 3", buitenmaat 4", lengte 12", met kunststof huis	B	201,65	244,00
	RL31/2PH	Rubberlager voor as Ø 3 ½", buitenmaat 4 ½", lengte 14", met kunststof huis	B	685,12	829,00
	RL4PH	Rubberlager voor as Ø 4", buitenmaat 5", lengte 16", met kunststof huis	B	362,81	439,00

RUBBERLAGER MET ASMAAT IN INCHES EN BUITENMAAT IN INCHES

	RULAG1	Rubberlager voor as Ø1", buitenmaat 1 ½", lengte 4", met messing huis	B	28,06	33,95
	RULAG11/8	Rubberlager voor as Ø 1 ¼", buitenmaat 1 ¾", lengte 4 ½", met messing huis	B	41,28	49,95
	RULAG11/4	Rubberlager voor as Ø 1 ¼", buitenmaat 1 ¾", lengte 5", met messing huis	B	42,15	51,00
	RULAG13/8	Rubberlager voor as Ø 1 ¾", buitenmaat 1 ¾", lengte 5 ½", met messing huis	B	45,45	55,00
	RULAG11/2	Rubberlager voor as Ø 1 ½", buitenmaat 2", lengte 6", met messing huis	B	47,93	58,00
	RULAG15/8	Rubberlager voor as Ø1 ¾", 2 ¼" buitenmaat lengte 6 ½" met messing huis	B	602,48	729,00
	RULAG13/4	Rubberlager voor as Ø 1 ¾", buitenmaat 2", lengte 6", met messing huis	B	137,19	166,00
	RULAG2	Rubberlager voor as Ø 2", buitenmaat 2 ¾", lengte 8", met messing huis	B	150,41	182,00
	RULAG21/4	Rubberlager voor as Ø 2 ¼", buitenmaat 3", lengte 9", met messing huis	B	178,51	216,00
	RULAG21/2	Rubberlager voor as Ø 2 ½", buitenmaat 3 ¼", lengte 10", met messing huis	B	203,31	246,00
	RULAG23/4	Rubberlager voor as Ø 2 ¾", buitenmaat 3 ¾", lengte 11", met messing huis	B	296,69	359,00
	RULAG3	Rubberlager voor as Ø 3", buitenmaat 4", lengte 12", met messing huis	B	395,87	479,00
	RULAG31/2	Rubberlager voor as Ø 3 ½", buitenmaat 4 ½", lengte 14", met messing huis	B	883,47	1069,00

RULAG4	Rubberlager voor as Ø 4", buitenmaat 5", lengte 16", met messing huis	B	1.090,08	1319,00
RULAG25PH	Rubberlager voor as Ø 25 mm, buitenmaat Ø 1 ½", lengte 100 mm, met kunststof huis	B	52,89	64,00
RULAG30PH	Rubberlager voor as Ø 30 mm, buitenmaat Ø 1 ¾", lengte 120 mm, met kunststof huis	B	59,50	72,00
RULAG35PH	Rubberlager voor as Ø 35 mm, buitenmaat Ø 1 ⅞", lengte 140 mm, met kunststof huis	B	61,16	74,00
RULAG40PH	Rubberlager voor as Ø 40 mm, buitenmaat Ø 2 ⅛", lengte 160 mm, met kunststof huis	B	73,55	89,00
RULAG45PH	Rubberlager voor as Ø 45 mm, buitenmaat Ø 2 ¾", lengte 180 mm, met kunststof huis	B	91,74	111,00
RULAG50PH	Rubberlager voor as Ø 50 mm, buitenmaat Ø 3", lengte 200 mm, met kunststof huis	B	98,35	119,00
RULAG60PH	Rubberlager voor as Ø 60 mm, buitenmaat Ø 3 ½", lengte 240 mm, met kunststof huis	B	118,18	143,00
RULAG70PH	Rubberlager voor as Ø 70 mm, buitenmaat Ø 4", lengte 280 mm, met kunststof huis	B	171,90	208,00
RULAG80PH	Rubberlager voor as Ø 80 mm, buitenmaat Ø 4", lengte 320 mm, met kunststof huis	B	371,07	449,00

Andere maten op aanvraag leverbaar

UITLAATSYSTEMEN

WATERLOCK TYPE LP

106	WLOCKLP30	Kunststof waterlock LP30	C	142,98	173,00
	WLOCKL40R	Waterlock, kunststof LP40, met draaibare inlaat	C	152,07	184,00
	WLOCKL45R	Waterlock, kunststof LP45, met draaibare inlaat	C	152,07	184,00
	WLOCKL50R	Waterlock, kunststof LP50, met draaibare inlaat	C	152,07	184,00
	WLOCKL50S	Waterlock, kunststof LP50 "Super"	C	263,64	319,00
	WLOCKLP60	Waterlock, kunststof LP60	C	263,64	319,00
	WLOCKLP75	Waterlock, kunststof LP75	C	263,64	319,00
	WLOCKLP90	Waterlock, kunststof LP90	C	263,64	319,00

WATERLOCKS VOOR LANGE UITLAATLEIDINGEN

107	LSS40A	Waterlock, kunststof LSS40, Ø 40 mm, met draaibare in-en uitlaat	C	263,64	319,00
	LSS45A	Waterlock, kunststof LSS45, Ø 45 mm, met draaibare in-en uitlaat	C	263,64	319,00
	LSS50A	Waterlock, kunststof LSS50, Ø 50 mm, met draaibare in-en uitlaat	C	263,64	319,00
	LSL60	Waterlock, kunststof LSL60	C	199,17	241,00
	LSL75	Waterlock, kunststof LSL75	C	199,17	241,00
	LSL90	Waterlock, kunststof LSL90	C	199,17	241,00
	LSG60	Waterlock, kunststof LSG60, Ø 60 mm, met draaibare in-en uitlaat	C	453,72	549,00
	LSG75	Waterlock, kunststof LSG75, Ø 75 mm, met draaibare in-en uitlaat	C	453,72	549,00
	LSG90	Waterlock, kunststof LSG90, Ø 90 mm, met draaibare in-en uitlaat	C	453,72	549,00

WATERLOCK/ GELUIDDEMPER TYPE NLP

108	NLP40	Waterlock, kunststof type NLP40	C	214,05	259,00
	NLP45	Waterlock, kunststof type NLP45	C	214,05	259,00
	NLP50	Waterlock, kunststof type NLP50	C	214,05	259,00
	NLP50S	Waterlock, kunststof type NLP50 S "Super"	C	304,96	369,00
	NLP60	Waterlock, kunststof type NLP60	C	304,96	369,00
Nieuw!	NLP65	Waterlock, kunststof type NLP65	C	304,96	369,00
	NLP75	Waterlock, kunststof type NLP75	C	304,96	369,00
	NLP90	Waterlock, kunststof type NLP90	C	304,96	369,00









GELUIDDEMPER/ZWANENHALS

109	NLPH40	Waterlock / Geluiddemper type NLPH, horizontaal, kunststof, 40 mm	C	204,96	248,00
	NLPH45	Waterlock / Geluiddemper type NLPH, horizontaal, kunststof, 45 mm	C	204,96	248,00
	NLPH50	Waterlock / Geluiddemper type NLPH, horizontaal, kunststof, 50 mm	C	204,96	248,00
	NLPH60	Waterlock / Geluiddemper type NLPH, horizontaal, kunststof, 60 mm	C	304,96	369,00
	NLPH75	Waterlock / Geluiddemper type NLPH, horizontaal, kunststof, 75 mm	C	304,96	369,00
	NLPH90	Waterlock / Geluiddemper type NLPH, horizontaal, kunststof, 90 mm	C	304,96	369,00

WATERLOCK/GELUIDDEMPER type NLP-3



	NLP340	Waterlock/geluiddemper type NLP340, 3-kamer, kunststof, 40 mm	C	263,64	319,00
	NLP345	Waterlock/ geluiddemper type NLP345, 3-kamer, kunststof, 45 mm	C	263,64	319,00
	NLP350	Waterlock/ geluiddemper type NLP350, 3-kamer, kunststof, 50 mm	C	263,64	319,00
	NLP360	Waterlock/geluiddemper type NLP360, 3-kamer, kunststof, 60 mm	C	362,81	439,00
	NLP375	Waterlock/ geluiddemper type NLP375, 3-kamer, kunststof, 75 mm	C	362,81	439,00
	NLP390	Waterlock/ geluiddemper type NLP390, 3-kamer, kunststof, 90 mm	C	362,81	439,00
	NLP36015L	Waterlock/geluiddemper type NLP360 (15 L), 3-kamer, kunststof, 60 mm	C	437,19	529,00
	NLP37515L	Waterlock/ geluiddemper type NLP375 (15 L), 3-kamer, kunststof, 75 mm	C	437,19	529,00
	NLP39015L	Waterlock/ geluiddemper type NLP390 (15 L), 3-kamer, kunststof, 90 mm	C	437,19	529,00



		WATERLOCKS VOOR UITLATEN VAN Ø 90 TOT EN MET Ø 250 mm.			
	110	MGP9090	Waterlock, kunststof type MGP, inlaat 90 mm -45 graden, uitlaat 90 mm.	C 726,45 879,00	
		MGP102102	Waterlock, kunststof type MGP, inlaat 102 mm -45 graden, uitlaat 102 mm.	C 726,45 879,00	
		MGP5455	Waterlock, kunststof type MGP, inlaat 127 mm -45 graden, uitlaat 127 mm.	C 726,45 879,00	
		MGP102127	Waterlock, kunststof type MGP, inlaat 102 mm -45 graden, uitlaat 127 mm.	C 726,45 879,00	
			MGS5455A	Waterlock, kunststof type MGS, inlaat 127 mm -45 graden, uitlaat 127 mm.	C 842,15 1019,00
			MGS5456A	Waterlock, kunststof type MGS, inlaat 127 mm -45 graden, uitlaat 152 mm.	C 842,15 1019,00
			MGS6456A	Waterlock, kunststof type MGS, inlaat 152 mm -45 graden, uitlaat 152 mm.	C 842,15 1019,00
			MGL6458A	Waterlock, kunststof type MGL, inlaat 152 mm -45 graden, uitlaat 203 mm.	C 957,85 1159,00
			MGL8458A	Waterlock, kunststof type MGL, inlaat 203 mm -45 graden, uitlaat 203 mm.	C 957,85 1159,00
			MGL84510A	Waterlock, kunststof type MGL, inlaat 203 mm -45 graden, uitlaat 254 mm.	C 957,85 1159,00
		UITLAATSYSTEMEN VOOR SNELLE SCHEPEN			
	111	MV090	Demper, kunststof type MV090, Ø 90 mm	C 536,36 649,00	
		MV100	Demper, kunststof type MV100, Ø 100 mm	C 536,36 649,00	
		MV125	Demper, kunststof type MV125, Ø 125 mm	C 718,18 869,00	
		MV150	Demper, kunststof type MV150, Ø 150 mm	C 718,18 869,00	
			MF090	Demper, kunststof type MF090, Ø 90 mm	C 420,66 509,00
			MF100	Demper, kunststof type MF100, Ø 100 mm	C 420,66 509,00
			MF125	Demper, kunststof type MF125, Ø 125 mm	C 594,21 719,00
			MF150	Demper, kunststof type MF150, Ø 150 mm	C 594,21 719,00
				'HEAVY DUTY COMPOSITE' NLP WATERLOCKS	
	113	NLP40HD	Zwarte HD Composite Waterlock, type NLP40	C 222,31 269,00	
		NLP45HD	Zwarte HD Composite Waterlock, type NLP45	C 222,31 269,00	
		NLP50HD	Zwarte HD Composite Waterlock, type NLP50	C 222,31 269,00	
		NLP50SHD	Zwarte HD Composite Waterlock, type NLP50S	C 338,02 409,00	
		NLP60HD	Zwarte HD Composite Waterlock, type NLP60	C 338,02 409,00	
		NLP75HD	Zwarte HD Composite Waterlock, type NLP75	C 338,02 409,00	
		NLP90HD	Zwarte HD Composite Waterlock, type NLP90	C 338,02 409,00	
		HEAVY DUTY COMPOSITET HPW WATERLOCKS			
		HPW102	High performance Waterlock met Ø 102 mm inlaat	A 1.387,60 1679,00	
		HPW127	High performance Waterlock met Ø 127 mm inlaat	A 1.387,60 1679,00	
		HPW152	High performance Waterlock met Ø 152 mm inlaat	A 1.387,60 1679,00	
		HPW127152	High performance Waterlock met Ø 127 mm inlaat, Ø 152 mm uitlaat	A 1.387,60 1679,00	
		GELUIDDEMPER			
	114	DEMPMP40	Geluiddemper, kunststof MP40	C 114,88 139,00	
		DEMPMP45	Geluiddemper, kunststof MP45	C 114,88 139,00	
		DEMPMP50	Geluiddemper, kunststof MP50	C 114,88 139,00	
		DEMPMP60	Geluiddemper, kunststof MP60	C 114,88 139,00	
		DEMPMP75	Geluiddemper, kunststof MP75	C 190,91 231,00	
		DEMPMP90	Geluiddemper, kunststof MP90	C 190,91 231,00	
		DEMPMP100	Geluiddemper, kunststof MP100	C 338,02 409,00	
			GELUIDDEMPER/ZWANENHALS		
		NLPG40	Geluiddemper / Zwanenhals type NLPG, kunststof, 40 mm	C 204,96 248,00	
		NLPG45	Geluiddemper / Zwanenhals type NLPG, kunststof, 45 mm	C 204,96 248,00	
		NLPG50	Geluiddemper / Zwanenhals type NLPG, kunststof, 50 mm	C 204,96 248,00	
		NLPG60	Geluiddemper / Zwanenhals type NLPG, kunststof, 60 mm	C 304,96 369,00	
		NLPG75	Geluiddemper / Zwanenhals type NLPG, kunststof, 75 mm	C 304,96 369,00	
		NLPG90	Geluiddemper / Zwanenhals type NLPG, kunststof, 90 mm	C 304,96 369,00	
		ZWANENHALS			
	115	WLOCKLT40	Zwanenhals, kunst LT40	C 133,88 162,00	
		WLOCKLT45	Zwanenhals, kunst LT45	C 133,88 162,00	
		WLOCKLT50	Zwanenhals, kunst LT50	C 133,88 162,00	
		WLOCKLT60	Zwanenhals, kunst LT60	C 133,88 162,00	
		LT6565	Zwanenhals, kunststof met ingang van Ø 65 mm en uitgang van Ø 65 mm	C 271,90 329,00	
		LT6575	Zwanenhals, kunststof met ingang van Ø 65 mm en uitgang van Ø 75 mm	C 271,90 329,00	
		LT7575	Zwanenhals, kunststof met ingang van Ø 75 mm en uitgang van Ø 75 mm	C 271,90 329,00	
		LT9090	Zwanenhals, kunststof met ingang van Ø 90 mm en uitgang van Ø 90 mm	C 304,96 369,00	
		LT90110	Zwanenhals, kunststof met ingang van Ø 90 mm en uitgang van Ø 110 mm	C 178,51 216,00	
		LT102	Zwanenhals, kunststof met ingang van Ø 102 mm en uitgang van Ø 102 mm	C 338,02 409,00	

LT110110	Zwanenhals, kunststof met ingang van Ø 110 mm en uitgang van Ø 110 mm	C	178,51	216,00	
LT127	Zwanenhals, kunststof met ingang van Ø 127 mm en uitgang van Ø 127 mm	C	280,17	339,00	
LT152	Zwanenhals, kunststof met ingang van Ø 152 mm en uitgang van Ø 152 mm	C	280,17	339,00	

BELUCHTER

116	ASDV	Beluchter type ASD 13/19/25/32 mm, met klep	C	103,31	125,00	
	ASDH	Beluchter type ASD 13/19/25/32 mm, met slang	C	103,31	125,00	
	ASDVS	Reserveset ASDV/H kleppen	ST	17,31	20,95	
117	ASD38V	Beluchter type ASD 38 mm, met klep	C	103,31	125,00	
	ASD38H	Beluchter type ASD 38 mm, met slang	C	103,31	125,00	
	AIRVENTV	Beluchter, type AIRVENT, 13/19/25/32 mm, met klep	C	103,31	125,00	
	AIRVENTH	Beluchter, type AIRVENT, 13/19/25/32 mm, met slang.	C	103,31	125,00	
	AV006	Klep beluchter	ST	14,01	16,95	



GAS/WATER-SCHEIDER

118	LGS4038	Uitlaatgasseparator 38 met 2 draaibare slangaansluitingen van Ø 40 mm	C	338,02	409,00	
	LGS4538	Uitlaatgasseparator 38 met 2 draaibare slangaansluitingen van Ø 45 mm	C	338,02	409,00	
	LGS5038	Uitlaatgasseparator 38 met 2 draaibare slangaansluitingen van Ø 50 mm	C	338,02	409,00	
	LGS6050	Uitlaatgasseparator 50 met 2 draaibare slangaansluitingen van Ø 60 mm	C	420,66	509,00	
	LGS7550	Uitlaatgasseparator 50 met 2 draaibare slangaansluitingen van Ø 75 mm	C	420,66	509,00	
	LGS9075	Uitlaatgasseparator 75 met 2 draaibare slangaansluitingen van Ø 90 mm	C	420,66	509,00	



UITLAAT-SPIEGELDOORVOEREN

119	TRC40R	Uitlaat-spiegeldoover, rubber, Ø 40 mm	C	65,29	79,00	
	TRC45R	Uitlaat-spiegeldoover, rubber, Ø 45 mm	C	74,38	90,00	
	TRC50R	Uitlaat-spiegeldoover, rubber, Ø 50 mm	C	74,38	90,00	
	TRC60R	Uitlaat-spiegeldoover, rubber, Ø 60 mm	C	74,38	90,00	
	TRC7590R	Uitlaat-spiegeldoover, rubber, Ø 76 of 90 mm	C	171,07	207,00	
	TRC40PV	Uitlaat-spiegeldoover met terugslagklep, kunststof, Ø 40 mm.	C	33,84	40,95	
	TRC45PV	Uitlaat-spiegeldoover met terugslagklep, kunststof, Ø 45 mm.	C	34,67	41,95	
	TRC50PV	Uitlaat-spiegeldoover met terugslagklep, kunststof, Ø 50 mm.	C	42,98	52,00	
	TRC60PV	Uitlaat-spiegeldoover met terugslagklep, kunststof, Ø 60 mm.	C	42,98	52,00	
	TRC75PV	Uitlaat-spiegeldoover met terugslagklep, kunststof, Ø 76 mm.	C	80,99	98,00	
	TRC90PV	Uitlaat-spiegeldoover met terugslagklep, kunststof, Ø 90 mm.	C	82,64	100,00	
	TRC40SV	Uitlaat-spiegeldoover met terugslagklep, roestvast staal, Ø 40 mm	C	90,91	110,00	
	TRC45SV	Uitlaat-spiegeldoover met terugslagklep, roestvast staal, Ø 45 mm	C	101,65	123,00	
	TRC50SV	Uitlaat-spiegeldoover met terugslagklep, roestvast staal, Ø 50 mm	C	100,83	122,00	
	TRC60SV	Uitlaat-spiegeldoover met terugslagklep, roestvast staal, Ø 60 mm	C	112,40	136,00	
	TRC75SV	Uitlaat-spiegeldoover met terugslagklep, roestvast staal, Ø 76 mm	C	147,11	178,00	
	TRC90SV	Uitlaat-spiegeldoover met terugslagklep, roestvast staal, Ø 90 mm	C	170,25	206,00	
	TRC100SV	Uitlaat-spiegeldoover met terugslagklep, roestvast staal, Ø 102 mm	C	222,31	269,00	
	TRC125SV	Uitlaat-spiegeldoover met terugslagklep, roestvast staal, Ø 127 mm	C	395,87	479,00	
	TRC150SV	Uitlaat-spiegeldoover met terugslagklep, roestvast staal, Ø 152 mm	C	478,51	579,00	
	TC090	Uitlaat-spiegeldoover met terugslagklep, kunststof, Ø 90 mm	C	104,13	126,00	
	TC100	Uitlaat-spiegeldoover met terugslagklep, kunststof, Ø102 mm	C	135,54	164,00	
	TC125	Uitlaat-spiegeldoover met terugslagklep, kunststof, Ø127 mm	C	182,64	221,00	
	TC150	Uitlaat-spiegeldoover met terugslagklep, kunststof, Ø152 mm	C	194,21	235,00	





UITLAATTEMPERATUUR ALARM

120	XHI12B	Uitlaattemperatuur-alarmsysteem 12 Volt, zwart (excl.sensor)	C	88,43	107,00	
	XHI24B	Uitlaattemperatuur-alarmsysteem 24 Volt, zwart (excl.sensor)	C	88,43	107,00	
	XHI12W	Uitlaattemperatuur-alarmsysteem 12 Volt, beige (excl.sensor)	C	88,43	107,00	
	XHI24W	Uitlaattemperatuur-alarmsysteem 24 Volt, beige (excl.sensor)	C	88,43	107,00	
	XHSM	Sensor voor uitlaatalarm te monteren op MF/MV/LSG/LSS/MGS/MGL/MGP	C	119,01	144,00	
	XHSH	Sensor voor uitlaatalarm te monteren op uitlaatslang	C	119,01	144,00	





SILICONESLANG

121	SIHOSE25	Silicone slang inw. Ø 25,4 mm (1") (Rol van 20 meter, Prijs per meter)	C	52,07	63,00	
	SIHOSE32	Silicone slang inw. Ø 32 mm (1 1/4") (Rol van 20 meter, Prijs per meter)	C	60,33	73,00	
	SIHOSE38	Silicone slang inw. Ø 38 mm (1 1/2") (Rol van 20 meter, Prijs per meter)	C	67,77	82,00	
	SIHOSE51	Silicone slang inw. Ø 50,8 mm (2") (Rol van 20 meter, Prijs per meter)	C	104,13	126,00	
	SIHOSE63	Silicone slang inw. Ø 63,5 mm (2 1/2") (Rol van 20 meter, Prijs per meter)	C	125,62	152,00	
	SIHOSE76	Silicone slang inw. Ø 76,2 mm (3") (Rol van 20 meter, Prijs per meter)	C	157,02	190,00	
	SIHOSE102	Silicone slang inw. Ø 101,6 mm (4") (Rol van 20 meter, Prijs per meter)	C	230,58	279,00	









UITLAATSLANGEN (Lloyd's goedgekeurd. Voldoet aan SAE-J 2006 R2)

	SLANG30	Rubberen uitlaatslang, inw. Ø30 mm (Rol van 20 meter, Prijs per meter)	C	36,32	43,95
	SLANG40	Rubberen uitlaatslang, inw. Ø40 mm (Rol van 20 meter, Prijs per meter)	C	40,45	48,95
	SLANG45	Rubberen uitlaatslang, inw. Ø45 mm (Rol van 20 meter, Prijs per meter)	C	43,80	53,00
	SLANG50	Rubberen uitlaatslang, inw. Ø51 mm (Rol van 20 meter, Prijs per meter)	C	46,28	56,00
	SLANG57	Rubberen uitlaatslang, inw. Ø57 mm (Rol van 20 meter, Prijs per meter)	C	50,41	61,00
	SLANG60	Rubberen uitlaatslang, inw. Ø60 mm (Rol van 20 meter, Prijs per meter)	C	52,89	64,00
	SLANG65	Rubberen uitlaatslang, inw. Ø65 mm (Rol van 20 meter, Prijs per meter)	C	59,50	72,00
	SLANG75	Rubberen uitlaatslang, inw. Ø76 mm (Rol van 20 meter, Prijs per meter)	C	65,29	79,00
	SLANG90	Rubberen uitlaatslang, inw. Ø90 mm (Rol van 20 meter, Prijs per meter)	C	72,73	88,00
	SLANG100	Rubberen uitlaatslang, inw. Ø102 mm (Rol van 20 meter, Prijs per meter)	C	76,03	92,00
	SLANG110	Rubberen uitlaatslang, inw. Ø110 mm (Rol van 20 meter, Prijs per meter)	C	90,91	110,00
	SLANG125	Rubberen uitlaatslang, inw. Ø127 mm (Rol van 20 meter, Prijs per meter)	C	109,09	132,00
	SLANG150	Rubberen uitlaatslang, inw. Ø152 mm (Rol van 20 meter, Prijs per meter)	C	131,40	159,00
	SLANG200	Rubberen uitlaatslang, inw. Ø203 mm (rol van 12 m, prijs per meter)	C	166,12	201,00
	SLANG250	Rubberen uitlaatslang, inw. Ø254 mm (rol van 12m, prijs per meter)	C	263,64	319,00
	SLANG300	Rubberen uitlaatslang, inw. Ø305 mm (rol van 12 m, prijs per meter)	C	313,22	379,00

UITLAATSLANGEN (RINA goedgekeurd)

	Nieuw!	SLANG30R	Rubberen uitlaatslang, inw. Ø30 mm (Rol van 20 meter, Prijs per meter)	C	36,32	43,95
	Nieuw!	SLANG40R	Rubberen uitlaatslang, inw. Ø40 mm (Rol van 20 meter, Prijs per meter)	C	42,98	52,00
	Nieuw!	SLANG45R	Rubberen uitlaatslang, inw. Ø45 mm (Rol van 20 meter, Prijs per meter)	C	43,80	53,00
	Nieuw!	SLANG50R	Rubberen uitlaatslang, inw. Ø51 mm (Rol van 20 meter, Prijs per meter)	C	46,28	56,00
	Nieuw!	SLANG60R	Rubberen uitlaatslang, inw. Ø60 mm (Rol van 20 meter, Prijs per meter)	C	51,24	62,00
	Nieuw!	SLANG65R	Rubberen uitlaatslang, inw. Ø65 mm (Rol van 20 meter, Prijs per meter)	C	59,50	72,00
	Nieuw!	SLANG75R	Rubberen uitlaatslang, inw. Ø76 mm (Rol van 20 meter, Prijs per meter)	C	64,46	78,00
	Nieuw!	SLANG90R	Rubberen uitlaatslang, inw. Ø90 mm (Rol van 20 meter, Prijs per meter)	C	71,90	87,00
	Nieuw!	SLANG100R	Rubberen uitlaatslang, inw. Ø102 mm (Rol van 20 meter, Prijs per meter)	C	79,34	96,00
	Nieuw!	SLANG110R	Rubberen uitlaatslang, inw. Ø110 mm (Rol van 20 meter, Prijs per meter)	C	82,64	100,00
	Nieuw!	SLANG125R	Rubberen uitlaatslang, inw. Ø127 mm (Rol van 20 meter, Prijs per meter)	C	104,96	127,00
	Nieuw!	SLANG150R	Rubberen uitlaatslang, inw. Ø152 mm (Rol van 20 meter, Prijs per meter)	C	132,23	160,00

KUNSTSTOF SLANGVERBINDERS

	122	SLVBR40K	Plastic slangverbinding recht Ø 40 mm	C	10,70	12,95
		SLVBR45K	Plastic slangverbinding recht Ø 45 mm	C	11,53	13,95
		SLVBR50K	Plastic slangverbinding recht Ø 50 mm	C	13,18	15,95
		SLVBR60K	Plastic slangverbinding recht Ø 60 mm	C	23,10	27,95
		SLVBR65K	Plastic slangverbinding recht Ø 65 mm	C	25,58	30,95
		SLVBR75K	Plastic slangverbinding recht Ø 75 mm	C	27,23	32,95
		SLVBR90K	Plastic slangverbinding recht Ø 90 mm	C	36,32	43,95
		SLVBR100K	Plastic slangverbinding recht Ø 100 mm	C	37,98	45,95
		SLVBR110K	Plastic slangverbinding recht Ø 110 mm	C	39,63	47,95
		SLVBR125K	Plastic slangverbinding recht Ø 125 mm	C	42,98	52,00
		SLVBR150K	Plastic slangverbinding recht Ø 150 mm	C	46,28	56,00
		SLVBG40K	Plastic slangverbindingen 60° gebogen Ø 40 mm	C	15,66	18,95
		SLVBG45K	Plastic slangverbindingen 60° gebogen Ø 45 mm	C	15,66	18,95
		SLVBG50K	Plastic slangverbindingen 60° gebogen Ø 50 mm	C	15,66	18,95
		SLVBG60K	Plastic slangverbindingen 60° gebogen Ø 60 mm	C	46,28	56,00
		SLVBG65K	Plastic slangverbindingen 60° gebogen Ø 65 mm	C	46,28	56,00
		SLVBG75K	Plastic slangverbindingen 60° gebogen Ø 75 mm	C	46,28	56,00
		SLVBG90K	Plastic slangverbindingen 60° gebogen Ø 90 mm	C	49,59	60,00
		SLVBG100K	Plastic slangverbindingen 60° gebogen Ø 100 mm	C	49,59	60,00
		SLVBG110K	Plastic slangverbindingen 60° gebogen Ø 110 mm	C	49,59	60,00
		SLVBG125K	Plastic slangverbindingen 60° gebogen Ø 125 mm	C	67,77	82,00
		SLVBG150K	Plastic slangverbindingen 60° gebogen Ø 150 mm	C	67,77	82,00
		ELB90127	Plastic slangverbindingen 90° gebogen Ø 127 mm	C	98,35	119,00
		ELB90152	Plastic slangverbindingen 90° gebogen Ø 152 mm	C	112,40	136,00
		ELB90203	Plastic slangverbindingen 90° gebogen Ø 203 mm	C	166,12	201,00
		ELB90254	Plastic slangverbindingen 90° gebogen Ø 254 mm	C	199,17	241,00
		MGVIB45	Trillingsdemper voor MGP	C	102,48	124,00
		MGVIB55	Trillingsdemper voor MGS en MGL	C	102,48	124,00
		MIXER090	Waterwervelaar voor uitlaatslang Ø 90 mm.	C	128,10	155,00
		MIXER100	Waterwervelaar voor uitlaatslang Ø 100 mm.	C	134,71	163,00
		MIXER125	Waterwervelaar voor uitlaatslang Ø 125 mm.	C	158,68	192,00
		MIXER150	Waterwervelaar voor uitlaatslang Ø 150 mm.	C	185,95	225,00

SCHEEPSINSTRUMENTEN

ALUMINIUM MOTORPANELEN

TYPE MPA34

	MPA34BW4	Aluminium motorpaneel type MPA34, 24V, 4 witte instrumenten (0-4000 tpm)	A	734,71	889,00
	MPA34CANBS2	Aluminium motorpaneel type MPA34 CAN, 12V, 4 zwarte instrumenten (0-4000 tpm)	A	850,41	1029,00
	MPA34CANBS4	Aluminium motorpaneel type MPA34 CAN, 24V, 4 zwarte instrumenten (0-4000 tpm)	A	850,41	1029,00

UITBREIDINGSPANEEL

	MPA1XB	Aluminium uitbreidingspaneel voor 2 instrumenten 2" (excl. instrumenten)	A	62,81	76,00
--	---------------	--------------------------------------------------------------------------	---	-------	-------

TYPE MPA22

128	MPA22KBS2	Aluminium motorpaneel type MPA22, 12V, 2 zwarte instrumenten (0-4000 tpm)	A	561,16	679,00
	MPA22KBS25	Aluminium motorpaneel type MPA22 gen 2, 12 V, 2 zwarte instrumenten (0-5000 tpm)	A	561,16	679,00
	MPA22KBW2	Aluminium motorpaneel type MPA22, 12V, 2 witte instrumenten (0-4000 tpm)	A	561,16	679,00
	MPA22KBW25	Aluminium motorpaneel type MPA22 gen 2, 12 V, 2 witte instrumenten (0-5000 tpm)	A	569,42	689,00

UITBREIDINGSPANEEL

	MPA1XB	Aluminium uitbreidingspaneel voor 2 instrumenten 2" (excl. instrumenten)	A	62,81	76,00
	MPA10	Aluminium motorpaneel 12V, zwart	A	412,40	499,00

KUNSTSTOF MOTORPANELEN

Type MP22

	MP22KBS2	2e gen motorpaneel type MP22, 12V, 2 zwarte meters, (0-4000 tpm)	0	519,83	629,00
	MP22KBS2D	2e gen motorpaneel type MP22, 12V, 2 zwarte meters, (0-4000 tpm), geschikt voor gebruik van tweede dynamo	0	519,83	629,00
	MP22KBS4	2e gen motorpaneel type MP22, 24V, 2 zwarte meters, (0-4000 tpm)	0	495,04	599,00
	MP22KBW2	2e gen motorpaneel type MP22, 12V, 2 witte meters, (0-4000 tpm)	0	495,04	599,00

Type MP34

	MP34KBS2	2e gen motorpaneel type MP34, 12V, 4 zwarte meters, (0-4000 tpm)	0	668,60	809,00
	MP34KBS2D	2e gen motorpaneel type MP34, 12V, 4 zwarte meters, (0-4000 tpm), geschikt voor gebruik van tweede dynamo	0	668,60	809,00
	MP34KBS4	2e gen motorpaneel type MP34, 24V, 4 zwarte meters, (0-4000 tpm)	0	668,60	809,00
	MP34KBW2	2e gen motorpaneel type MP34, 12V, 4 witte meters, (0-4000 tpm)	0	668,60	809,00

UITBREIDINGSPANEEL

	XTPAN252A	Uitbreidingspaneel voor 2 instrumenten	A	28,88	34,95
--	------------------	----------------------------------------	---	-------	-------









AANSLUITKABEL

130	MPA1KB	Aluminium paneel voor startsleutel	A	114,88	139,00
	MPA1MB	Aluminium monitor paneel, 12V, zwart	A	130,58	158,00
	XTASF2P	Aluminium uitbreidingspaneel voor 2 instrumenten Ø75 mm	ST	23,10	27,95

	MPKA02	Tussenkabel A, 2M	A	99,17	120,00
	MPKA04	Tussenkabel A, 4M	A	108,26	131,00
	MPKA06	Tussenkabel A, 6M	A	123,14	149,00
	MPKA12	Tussenkabel A, 12M	A	153,72	186,00
	MPKB02	Tussenkabel B, 2M	A	70,25	85,00
	MPKB04	Tussenkabel B, 4M	A	76,86	93,00
	MPKB06	Tussenkabel B, 6M	A	88,43	107,00
	MPKB12	Tussenkabel B, 12M	A	114,05	138,00
	MPKC02	Tussenkabel C, 2M	A	31,36	37,95
	MPKC04	Tussenkabel C, 4M	A		35,50
	MPKC06	Tussenkabel C, 6M	A		40,45
	MPKC12	Tussenkabel C, 12M	A	53,72	65,00
	MPYA	Y-stuk voor tweede paneel A-A-A	A	101,65	123,00
	MPYB	Y-stuk voor tweede paneel B-B-B	A	70,25	85,00
	STM6911	Interface MP34 losse printplaat	SV	41,28	49,95
	MPVB2	Aansluitdeel B2 voor interface STM6911-MP34	A	69,42	84,00
	MPVC2	Aansluitdeel C2 voor aansluiten interface MP34	A	17,31	20,95
	MPUA01	Universele kabelboom A voor niet-VETUS motoren	A	46,28	56,00
	MPUB01	Universele kabelboom B voor niet-VETUS motoren	A	19,79	23,95
	MPUC01	Universele kabelboom C voor niet-VETUS motoren	A	15,66	18,95

131	TACHMD	Multifunctioneel rond display, Ø100 mm	A		Prijs op aanvraag
	CANA2J1	1-richting CAN converter	A		Prijs op aanvraag



	DOE-HET-ZELF DRAADBOOM				
132	PWLK	Bedrading voor motorinstrumenten	C	437,19	529,00
	TOERENTELLERS				
133	TACHB4000	Toerenteller met urenteller zwart, 12/24 Volt, (0-4000 RPM), gatmaat Ø 100 mm	C	114,05	138,00
	TACHW4000	Toerenteller met urenteller wit, 12/24 Volt, (0-4000 RPM), gatmaat Ø 100 mm	C	114,05	138,00
	TACHN4000	Toerenteller met urenteller beige, 12/24 Volt, (0-4000 RPM), gatmaat Ø 100 mm	C	114,05	138,00
	TACHB5000	Toerenteller met urenteller zwart, 12/24 Volt, (0-5000 RPM), gatmaat Ø 100 mm	C	114,05	138,00
	TACHW5000	Toerenteller met urenteller wit, 12/24 Volt, (0-5000 RPM), gatmaat Ø 100 mm	C	114,05	138,00
	TACHN5000	Toerenteller met urenteller beige, 12/24 Volt, (0-5000 RPM), gatmaat Ø 100 mm	C	114,05	138,00
	UITLAATGASTEMPERATUURALARM				
	XHI12B	Uitlaattemperatuur-alarmsysteem 12 Volt, zwart (excl.sensor)	C	88,43	107,00
	XHI24B	Uitlaattemperatuur-alarmsysteem 24 Volt, zwart (excl.sensor)	C	88,43	107,00
	XHI12W	Uitlaattemperatuur-alarmsysteem 12 Volt, beige (excl.sensor)	C	88,43	107,00
	XHI24W	Uitlaattemperatuur-alarmsysteem 24 Volt, beige (excl.sensor)	C	88,43	107,00
	XHSH	Sensor voor uitlaatalarm te monteren op uitlaatslang	C	119,01	144,00
	XHSM	Sensor voor uitlaatalarm te monteren op MF/MV/LSG/LSS/MGS/MGL/MGP	C	119,01	144,00
	TRI mm ETER				
	TRIMB	Tri mm eter voor Z-Drive, 12/24 Volt, zwart	C	57,85	70,00
	TRIMN	Tri mm eter voor Z-Drive, 12/24 Volt, beige	C	57,85	70,00
	TRIMW	Tri mm eter voor Z-Drive, 12/24 Volt, wit	C	57,85	70,00
	TRIMWR	Aansluitkit voor tri mm eter	C	31,36	37,95
	TEMPERATUURMETER				
134	TEMPB	Temperatuurmeter zwart, 12/24 Volt (40-120°C), gatmaat Ø 52 mm	C	66,12	80,00
	TEMPN	Temperatuurmeter beige, 12/24 Volt (40-120°C), gatmaat Ø 52 mm	C	66,12	80,00
	TEMPW	Temperatuurmeter wit, 12/24 Volt (40-120°C), gatmaat Ø 52 mm	C	66,12	80,00
	TEMPSR120	Zender voor temperatuurmeter 12/24 Volt, enkelpolig M14 x 1,5	C	15,66	18,95
	TEMPSR122	Zender voor temperatuurmeter 12/24 Volt, tweepolig M14 x 1,5	C	28,88	34,95
	URENTELLER				
	HOURCB	Urenteller zwart, 12/24 Volt, gatmaat Ø 52 mm	C	52,07	63,00
	HOURCN	Urenteller beige, 12/24 Volt, gatmaat Ø 52 mm	C	52,07	63,00
	HOURCW	Urenteller wit, 12/24 Volt, gatmaat Ø 52 mm	C	52,07	63,00
	VOLTMETER				
	VLT12B	Voltmeter zwart, 12 Volt (10-16V), gatmaat Ø 52 mm	C	66,12	80,00
	VLT24B	Voltmeter zwart, 24 Volt (20-32V), gatmaat Ø 52 mm	C	66,12	80,00
	VLT12N	Voltmeter beige, 12 Volt (10-16V), gatmaat Ø 52 mm	C	66,12	80,00
	VLT24N	Voltmeter beige, 24 Volt (20-32V), gatmaat Ø 52 mm	C	66,12	80,00
	VLT12W	Voltmeter wit, 12 Volt (10-16V), gatmaat Ø 52 mm	C	66,12	80,00
	VLT24W	Voltmeter wit, 24 Volt (20-32V), gatmaat Ø 52 mm	C	66,12	80,00
	AMPÈREMETER				
	AMP050B	Ampèremeter zwart, 12/24 Volt (+/- 50 Amp), gatmaat Ø 52 mm (incl. shunt)	C	92,56	112,00
	AMP050N	Ampèremeter beige, 12/24 Volt (+/- 50 Amp), gatmaat Ø 52 mm (incl. shunt)	C	92,56	112,00
	AMP050W	Ampèremeter wit, 12/24 Volt (+/- 50 Amp), gatmaat Ø 52 mm (incl. shunt)	C	92,56	112,00
	AMP080B	Ampèremeter zwart, 12/24 Volt (+/- 80 Amp), gatmaat Ø 52 mm (incl. shunt)	C	92,56	112,00
	AMP080N	Ampèremeter beige, 12/24 Volt (+/- 80 Amp), gatmaat Ø 52 mm (incl. shunt)	C	92,56	112,00
	AMP080W	Ampèremeter wit, 12/24 Volt (+/- 80 Amp), gatmaat Ø 52 mm (incl. shunt)	C	92,56	112,00
	AMP150B	Ampèremeter zwart, 12/24 Volt (+/- 150 Amp), gatmaat Ø 52 mm (incl. shunt)	C	92,56	112,00
	AMP150N	Ampèremeter beige, 12/24 Volt (+/- 150 Amp), gatmaat Ø 52 mm (incl. shunt)	C	92,56	112,00
	AMP150W	Ampèremeter wit, 12/24 Volt (+/- 150 Amp), gatmaat Ø 52 mm (incl. shunt)	C	92,56	112,00
	VUILWATERNIVEAUMETER				
135	WASTB	Vuilwaterniveaumeter zwart, 12/24 Volt, gatmaat Ø 52 mm (excl. vlotter)	C	66,12	80,00
	WASTN	Vuilwaterniveaumeter beige, 12/24 Volt, gatmaat Ø 52 mm (excl. vlotter)	C	66,12	80,00
	WASTW	Vuilwaterniveaumeter wit, 12/24 Volt, gatmaat Ø 52 mm (excl. vlotter)	C	66,12	80,00
	EP412326	Interface voor vuilwaterniveau waarschuwing	C	60,33	73,00
	OLIEDRUKMETER				
	OILB	Oliedrukmeter zwart, 12/24 Volt (0-8 kg/cm ²), gatmaat Ø 52 mm	C	61,16	74,00
	OILN	Oliedrukmeter beige, 12/24 Volt (0-8 kg/cm ²), gatmaat Ø 52 mm	C	54,55	66,00
	OILW	Oliedrukmeter wit, 12 Volt (0-8 kg/cm ²), gatmaat Ø 52 mm	C	57,85	70,00
					

Nieuw!	OILSR08	Oliedruksensor 12/24V, enkelpolig, M10 x 1K	C	78,51	95,00	
Nieuw!	OILSR082	Oliedruksensor 12/24V, dubbelpolig, M10 x 1K	C	78,51	95,00	



BRANDSTOFMETER

FUELB	Brandstofniveaumeter zwart, 12/24 Volt, gatmaat Ø 52 mm (excl. vlotter)	C	66,12	80,00	
FUELN	Brandstofniveaumeter beige, 12/24 Volt, gatmaat Ø 52 mm (excl. vlotter)	C	66,12	80,00	
FUELW	Brandstofniveaumeter wit, 12/24 Volt, gatmaat Ø 52 mm (excl. vlotter)	C	66,12	80,00	



WATERNIVEAUMETER

WATERB	Waterniveaumeter zwart, 12/24 Volt, gatmaat Ø 52 mm (excl. vlotter)	C	66,12	80,00	
WATERN	Waterniveaumeter beige, 12/24 Volt, gatmaat Ø 52 mm (excl. vlotter)	C	66,12	80,00	
WATERW	Waterniveaumeter wit, 12/24 Volt, gatmaat Ø 52 mm (excl. vlotter)	C	66,12	80,00	



ROERSTANDAANWIJZER

136	RUddb	Roerstandaanwijzer zwart, 12/24 Volt, gatmaat Ø 52 mm (excl. geveer)	C	57,02	69,00	
	RUDDN	Roerstandaanwijzer beige, 12/24 Volt, gatmaat Ø 52 mm (excl. geveer)	C	57,02	69,00	
	RUDDW	Roerstandaanwijzer wit, 12/24 Volt, gatmaat Ø 52 mm (excl. geveer)	C	57,02	69,00	
	RUDDS	Roerstandgeveer type RUDDS	C	59,50	72,00	
	RUddb40	Roerstandaanwijzer zwart, 12/24 Volt, gatmaat Ø 100 mm (excl. geveer)	C	96,69	117,00	
	RUDDN40	Roerstandaanwijzer beige, 12/24 Volt, gatmaat Ø 100 mm (excl. geveer)	C	96,69	117,00	
	RUDDW40	Roerstandaanwijzer wit, 12/24 Volt, gatmaat Ø 100 mm (excl. geveer)	C	96,69	117,00	
	RUDDSHD	Heavy Duty roerstandgeveer RUDDSHD	C	168,60	204,00	
	BATMONB	Energieverbruiksmeter 12/24 Volt, incl. shunt 200 Amp max., gatmaat Ø 52 mm. Zwart	A	536,36	649,00	





TANKVLOTTERS

137	SENSOR280	Universele tankvlotter type Sensor, lengte 280 mm	C	57,85	70,00	
	SENSOR320	Universele tankvlotter type Sensor, lengte 320 mm	C	64,46	78,00	
	SENSOR380	Universele tankvlotter type Sensor, lengte 380 mm	C	70,25	85,00	
	SENSOR480	Universele tankvlotter type Sensor, lengte 480 mm	C	95,87	116,00	
	SENSOR580	Universele tankvlotter type Sensor, lengte 580 mm	C	114,88	139,00	
	SENSOR680	Universele tankvlotter type Sensor, lengte 680 mm	C	127,27	154,00	
	SENSOR780	Universele tankvlotter type Sensor, lengte 780 mm	C	133,88	162,00	
	WWSENSORA	Vuilwater tankvlotter 12/24 Volt	C	178,51	216,00	
	FSENSOR	Brandstof tankvlotter 140 - 660 mm, 12/24 Volt	C	52,07	63,00	

ULTRASOON NIVEAUSENOR

138	SENSORA	Ultrasoon niveausensor 12/24V, voor analoge aflezing voor water, brandstof en waste	C	170,25	206,00	
	SENSORB	Ultrasoon niveausensor 12/24V, voor bussysteem aflezing voor water, brandstof en waste	C	170,25	206,00	
	SENSORD	Display voor het aflezen middels bussysteem van niveau van tanks voor water, brandstof en waste	C	759,50	919,00	
139	FUSE06A4	Automatische zekeringen 6 Amp, voor P8FA (set van 4 stuks)	B	75,21	91,00	
	FUSE08A4	Automatische zekeringen 8 Amp, voor P8FA (set van 4 stuks)	B	75,21	91,00	
	FUSE10A4	Automatische zekeringen 10 Amp, voor P8FA (set van 4 stuks)	B	75,21	91,00	
	FUSE15A4	Automatische zekeringen 15 Amp, voor P8FA (set van 4 stuks)	B	75,21	91,00	

SCHAKELPANELEN

	P8FA	Schakelpaneel P8F, 12/24v, voor 8 zekeringen/automatische zekeringen (incl. 16 zekeringen)	B	247,11	299,00		
140	P6F12	Schakelpaneel type P 6 met 6 glaszekeringen, 12/24 Volt	B	169,42	205,00		
	P6F24	Schakelpaneel type P 6 met 6 glaszekeringen, 24 Volt	B	169,42	205,00		
	P12F12	Schakelpaneel type P12 met 12 glaszekeringen, 12/24 Volt	B	296,69	359,00		
	P12F24	Schakelpaneel type P12 met 12 glaszekeringen, 24 Volt	B	296,69	359,00		
	P6CB12	Schakelpaneel type P 6 met 6 circuit breakers, 12/24 Volt	B	263,64	319,00		
	P6CB24	Schakelpaneel type P 6 met 6 circuit breakers, 24 Volt	B	263,64	319,00		
	P12CB12	Schakelpaneel type P12 met 12 circuit breakers, 12/24 Volt	B	486,78	589,00		
	P12CB24	Schakelpaneel type P12 met 12 circuit breakers, 24 Volt	B	486,78	589,00		
141	GD1000	Gas/koolmonoxide detector 12/24 volt, incl. sensor	B	420,66	509,00		
	GSENSOR	Extra sensor voor gas/koolmonoxide detectie	B	189,26	229,00		
	PD1000	Benzinedamp detector 12/24 volt, incl. sensor	B	461,98	559,00		
	PSENSOR	Extra sensor voor benzinedamp detectie	B	222,31	269,00		



BRANDSTOFSYSTEMEN**SPIN-ON DIESEL FILTERS**

148	330VTEB	Brandstoffilter/waterafscheider CE/ABYC enkel 10 micron, tot max. 190l/h	A	204,13	247,00
	340VTEB	Brandstoffilter/waterafscheider CE/ABYC enkel 10 micron, tot max. 380l/h	A	214,05	259,00
Nieuw!	340VTER	Brandstoffilter/waterafscheider CE/ABYC enkel 30 micron, tot max. 620l/h	A	214,05	259,00
	350VTEB	Brandstoffilter/waterafscheider CE/ABYC enkel 10 micron, tot max. 460l/h	A	222,31	269,00
	330VTEPB	Brandstoffilter/waterafscheider CE/ABYC enkel 10 micron, tot max. 190l/h, met pomp	A	238,84	289,00
Nieuw!	330VTEPR	Brandstoffilter/waterafscheider CE/ABYC enkel 30 micron, tot max. 270l/h, met pomp	A	238,84	289,00
	340VTEPB	Brandstoffilter/waterafscheider CE/ABYC enkel 10 micron, tot max. 380l/h, met pomp	A	238,84	289,00
Nieuw!	340VTEPR	Brandstoffilter/waterafscheider CE/ABYC enkel 30 micron, tot max. 465l/h, met pomp	A	238,84	289,00
	350VTEPB	Brandstoffilter/waterafscheider CE/ABYC enkel 10 micron, tot max. 460l/h, met pomp	A	255,37	309,00
	75330VTEB	Brandstoffilter/waterafscheider CE/ABYC dubbel 10 micron, tot max. 190l/h	A	536,36	649,00
	75340VTEB	Brandstoffilter/waterafscheider CE/ABYC dubbel 10 micron, tot max. 620l/h	A	552,89	669,00
	75350VTEB	Brandstoffilter/waterafscheider CE/ABYC dubbel 10 micron, tot max. 460l/h	A	552,89	669,00

CENTRIFUGAAL DIESEL FILTERS

149	75100VTE	Brandstoffilter/waterafscheider CE/ABYC, dubbel 30 micron tot 12 ltr/min.	A	1.147,93	1389,00
	79100VTE	Brandstoffilter/waterafscheider CE/ABYC, drievoudig 30 micron tot 24 ltr/min.	A	1.693,39	2049,00
	83100VTE	Brandstoffilter/waterafscheider CE/ABYC, viervoudig 30 micron tot 36 ltr/min.	A	2.271,90	2749,00
	87100VTE	Brandstoffilter/waterafscheider CE/ABYC, vijfvoudig 30 micron tot 48 ltr/min.	A	2.850,41	3449,00
	91100VTE	Brandstoffilter/waterafscheider CE/ABYC, zesvoudig 30 micron tot 60 ltr/min.	A	3.387,60	4099,00

FILTERELEMENTEN VOOR SPIN-ON DIESEL FILTERS

150	VT33EB	Filterelement Diesel CE/ABYC 10 micron, tot max. 190l/h	A	60,33	73,00
	VT34EB	Filterelement Diesel CE/ABYC 10 micron, tot max. 380l/h	A	64,46	78,00
	VT35EB	Filterelement Diesel CE/ABYC 10 micron, tot max. 460l/h	A	68,60	83,00
	VT33ER	Filterelement Diesel CE/ABYC 30 micron, tot max. 190l/h	A	63,64	77,00
	VT34ER	Filterelement Diesel CE/ABYC 30 micron, tot max. 380l/h	A	66,12	80,00
	VT35ER	Filterelement Diesel CE/ABYC 30 micron, tot max. 460l/h	A	70,25	85,00

FILTERELEMENTEN VOOR CENTRIFUGAAL DIESEL FILTERS

	2020VTR	Filterelement diesel 30 micron tot 12 ltr/min.	A	25,58	30,95
	2020VTB	Filterelement diesel 10 micron tot 12 ltr/min.	A	23,93	28,95

BRANDSTOFFILTERSLANGAANSLUITINGEN

	FFS0800	Brandstoffilter met enkele 8 mm aansluiting, recht	A	17,31	20,95
	FFS0890	Brandstoffilter met enkele 8 mm aansluiting, gebogen	A	20,62	24,95
	FFS1000	Brandstoffilter met enkele 10 mm aansluiting, recht	A	17,31	20,95
	FFS1090	Brandstoffilter met enkele 10 mm aansluiting, gebogen	A	21,45	25,95
	FFS1300	Brandstoffilter met enkele 13 mm aansluiting, recht	A	40,45	48,95
	FFS1390	Brandstoffilter met enkele 13 mm aansluiting, gebogen	A	56,20	68,00
	FFD0800	Brandstoffilter met dubbele 8 mm aansluiting, recht	A	24,75	29,95
	FFD0890	Brandstoffilter met dubbele 8 mm aansluiting, gebogen	A	25,58	30,95
	FFD1000	Brandstoffilter met dubbele 10 mm aansluiting, recht	A	27,23	32,95
	FFD1090	Brandstoffilter met dubbele 10 mm aansluiting, gebogen	A	30,54	36,95

BENZINE + DIESEL FILTERS

151	WS180	Waterafscheider type WS180 (cap. 180 l/u)	C	116,53	141,00
	WS720	Waterafscheider type WS720 (cap. 720 l/u)	C	412,40	499,00
	WS180FE	Filterelement voor de WS180/720	C	44,63	54,00
	WS250FE	Filterelement voor de WS250	C	31,36	37,95
	WS750FE	Filterelement voor de WS750	C	43,80	53,00

BENZINE FILTERS

	320VTNEB	Benzine filter compleet	C	204,96	248,00
	VTN32EB	Filterelement bezine CE, 10 micron tot 120 l/u	C	67,77	82,00

BRANDSTOF-OVERLOOP

152	FSA3816	Brandstof-overloop type FSA, voor dekdop en vulslang Ø 38 mm, ontluftung Ø 16 mm	C	150,41	182,00
	FSA5116	Brandstof-overloop type FSA, voor dekdop en vulslang Ø 51 mm, ontluftung Ø 16 mm	C	150,41	182,00
	FSA5119	Brandstof-overloop type FSA, voor dekdop en vulslang Ø 51 mm, ontluftung Ø 19 mm	C	150,41	182,00
	FS3816	Brandstof-overloop, voor dekdop Ø 38 mm, vulslang Ø 38 mm, ontluftung Ø 16 mm	C	137,19	166,00
	FS5116	Brandstof-overloop, voor dekdop Ø 51 mm, vulslang Ø 51 mm, ontluftung Ø 16 mm	C	137,19	166,00
	FS5125	Brandstof-overloop, voor dekdop Ø 51 mm, vulslang Ø 51 mm, ontluftung Ø 25 mm	C	137,19	166,00

STANDAARD MULTIFUNCTIONELE TANKS ZONDER AANSLUITINGEN

153	ATANK042	42 ltr Dieselbrandstoftank (exclusief aansluitkit)	A	95,87	116,00	
	ATANK061	61 ltr Dieselbrandstoftank(exclusief aansluitkit)	A	111,57	135,00	
	ATANK088	88 ltr Dieselbrandstoftank (exclusief aansluitkit)	A	151,24	183,00	
	ATANK110	110 ltr Dieselbrandstoftank (exclusief aansluitkit)	A	177,69	215,00	
	ATANK137	137 ltr Dieselbrandstoftank(exclusief aansluitkit)	A	214,05	259,00	
	ATANK170	170 ltr Dieselbrandstoftank (exclusief aansluitkit)	A	247,11	299,00	
	ATANK215	215 ltr Dieselbrandstoftank(exclusief aansluitkit)	A	313,22	379,00	
	ATANK335	335 ltr Dieselbrandstoftank(exclusief aansluitkit)	A	486,78	589,00	
	ATANK390	390 ltr Dieselbrandstoftank(exclusief aansluitkit)	A	544,63	659,00	







VASTE TANKS VOOR DIESELBRANDSTOF (INCL. AANSLUITINGEN)

154	FTANK25	25 ltr dieselbrandstoftank incl. aansluitingen	B	146,28	177,00	
	FTANK40A	40 ltr dieselbrandstoftank incl. aansluitingen, voor 8 mm brandst. leiding	B	271,90	329,00	
	FTANK60A	60 ltr dieselbrandstoftank incl. aansluitingen, voor 8 mm brandst. leiding	B	288,43	349,00	
	FTANK80A	80 ltr dieselbrandstoftank incl. aansluitingen, voor 8 mm brandst. leiding	B	313,22	379,00	
	FTANK40B	40 ltr dieselbrandstoftank incl. aansluitingen, voor 10 mm brandst. leiding	B	271,90	329,00	
	FTANK60B	60 ltr dieselbrandstoftank incl. aansluitingen, voor 10 mm brandst. leiding	B	288,43	349,00	
	FTANK80B	80 ltr dieselbrandstoftank incl. aansluitingen, voor 10 mm brandst. leiding	B	313,22	379,00	





MULTIFUNCTIONELE TANK

	APT100	Multifunctionele tank, 100 liter	A	238,84	289,00	
	VTSTRAP	VETUS spanband, 2 stuks 3m x 25 mm met VETUS logo	A	10,70	12,95	



AANSLUITKIT VOOR BRANDSTOFTANKS

155	FTL3808B	Vullen 38 mm, retour/aanzuig 8 mm, ontlichten 16 mm	B	145,45	176,00	
	FTL3810B	Vullen 38 mm, retour/aanzuig 10 mm, ontlichten 16 mm	B	151,24	183,00	
	FTL3815B	Vullen 38 mm, retour/aanzuig 15 mm, ontlichten 16 mm	B	159,50	193,00	
	FTL5108B	Vullen 51 mm, retour/aanzuig 8 mm, ontlichten 16 mm	B	145,45	176,00	
	FTL5110B	Vullen 51 mm, retour/aanzuig 10 mm, ontlichten 16 mm	B	151,24	183,00	
	FTL5115B	Vullen 51 mm, retour/aanzuig 15 mm, ontlichten 16 mm	B	159,50	193,00	
	VTSTRAP	VETUS spanband, 2 stuks 3m x 25 mm met VETUS logo	A	10,70	12,95	
	FTLDB	Verbindingskit voor 2 brandstoftanks	B	166,12	201,00	
156	ILT120B	Inspectiedeksel 120 mm voor (<10% bio)diesel	A	69,42	84,00	
	ILT120X	Inspectiedeksel 120 mm met Viton pakking voor benzine of (>10% bio)diesel	A	95,87	116,00	
	WRILT	Moersleutel voor ILT120	A	7,40	8,95	
	VSAW159	Ø159 mm gatenzaag voor FTL. Voor kunststof, Polyester of metalen tanks	A	22,27	26,95	
	ILTCONF38	ILT aansluitset voor brandstof, vuldop Ø 38 mm, terugloop Ø 8 of 10 mm en ontlichting Ø 16 mm	A	51,24	62,00	
	ILTCON90	Slangaansluiting G1-1/4 38 mm gebogen	A	14,01	16,95	



GEURFILTERS VOOR DIESEL TANKS

157	NSF16D	Dieselolie-geurfilter groot, met aansluitingen voor Ø 16 mm slang	C	119,83	145,00	
	NSF19D	Dieselolie-geurfilter groot, met aansluitingen voor Ø 19 mm slang	C	119,83	145,00	
	NSF25D	Dieselolie-geurfilter groot, met aansluitingen voor Ø 25 mm slang	C	119,83	145,00	
	NSF16DS	Dieselolie-geurfilter klein, met aansluitingen voor Ø 16 mm slang	C	92,56	112,00	
	NSF16FES	Reserve filter voor geurfilter klein model	C	14,83	17,95	
	NSF16FE	Reservefilter voor geurfilter groot model	C	24,75	29,95	
	NSFCAN	Vervangings filterbussen met dubbele functie voor geurfilters type NSF	B	33,02	39,95	
	NSFCANS	Vervangings filterbussen met dubbele functie voor geurfilters type NSF_S	B	25,58	30,95	
158	VSAW114	Ø114 mm gatenzaag voor FTL. Voor kunststof, Polyester of metalen tanks	A	19,79	23,95	
	VSAW159	Ø159 mm gatenzaag voor FTL. Voor kunststof, Polyester of metalen tanks	A	22,27	26,95	

BRANDSTOF DIEFSTALBEVEILIGING

	FUELSAFE	Brandstof diefstalbeveiliging voor slang Ø 38 en 52 mm inw.	C	18,14	21,95	
		BRANDSTOF VULSLANG (ISO-7840-Marine Fuel A1 / SAE J 1527)				
	FFHOSE38	Brandstof-vulslang, inw.Ø 38 mm (Rol van 20 meter, Prijs per meter)	C	51,24	62,00	
	FFHOSE51	Brandstof-vulslang, inw.Ø 51 mm (Rol van 20 meter, Prijs per meter)	C	64,46	78,00	

BRANDSTOFSLANG (ISO-7840 - Marine Fuel A1)

159	FUHOSE05A	Brandstofslang, inw. Ø 5 mm (Rol van 30 meter, Prijs per meter)	C	9,88	11,95	
	FUHOSE06A	Brandstofslang, inw. Ø 6 mm (Rol van 30 meter, Prijs per meter)	C	11,53	13,95	
	FUHOSE08A	Brandstofslang, inw. Ø 8 mm (Rol van 30 meter, Prijs per meter)	C	12,36	14,95	
	FUHOSE10A	Brandstofslang, inw. Ø 10 mm (Rol van 30 meter, Prijs per meter)	C	12,36	14,95	

	FUHOSE13A	Brandstofslang, inw. Ø 13 mm (Rol van 30 meter, Prijs per meter)	C	15,66	18,95
	FUHOSE16A	Brandstofslang, inw. Ø 16 mm (Rol van 30 meter, Prijs per meter)	C	17,31	20,95
	FUHOSE19A	Brandstofslang, inw. Ø 19 mm (Rol van 30 meter, Prijs per meter)	C	24,75	29,95
	FUHOSE25A	Brandstofslang, inw. Ø 25 mm (Rol van 30 meter, Prijs per meter)	C	34,67	41,95

BRANDSTOFSLANG (ISO-7840 - Marine Fuel A1 - 15)

	FHA11506A	Brandstofslang 6 x 13 mm ISO 7840 (Rol van 30 meter, Prijs per meter)	B	11,53	13,95
	FHA11508A	Brandstofslang 8 x 16 mm ISO 7840 (Rol van 30 meter, Prijs per meter)	B	12,36	14,95
	FHA11510A	Brandstofslang 10 x 18 mm ISO 7840 (Rol van 30 meter, Prijs per meter)	B	13,18	15,95
	FHA11513A	Brandstofslang 13 x 22 mm ISO 7840 (Rol van 30 meter, Prijs per meter)	B	17,31	20,95

DRINKWATERSYSTEMEN**STANDAARD MULTIFUNCTIONELE TANKS ZONDER AANSLUITINGEN**

	ATANK042	42 ltr Drinkwatertank (exclusief aansluitkit)	A	95,87	116,00
	ATANK061	61 ltr Drinkwatertank(exclusief aansluitkit)	A	111,57	135,00
	ATANK088	88 ltr Drinkwatertank (exclusief aansluitkit)	A	151,24	183,00
	ATANK110	110 ltr Drinkwatertank (exclusief aansluitkit)	A	177,69	215,00
	ATANK137	137 ltr Drinkwatertank(exclusief aansluitkit)	A	214,05	259,00
	ATANK170	170 ltr Drinkwatertank (exclusief aansluitkit)	A	247,11	299,00
	ATANK215	215 ltr Drinkwatertank(exclusief aansluitkit)	A	313,22	379,00
	ATANK335	335 ltr Drinkwatertank(exclusief aansluitkit)	A	486,78	589,00
	ATANK390	390 ltr Drinkwatertank(exclusief aansluitkit)	A	544,63	659,00

MULTIFUNCTIONELE TANK

	APT100	Multifunctionele tank, 100 liter	A	238,84	289,00
	VTSTRAP	VETUS spanband, 2 stuks 3m x 25 mm met VETUS logo	A	10,70	12,95

VASTE TANKS VOOR DRINKWATER (INCL. AANSLUITINGEN)

166	WTANK40C	40 ltr drinkwatertank40 ltr incl. aansluitingen en insp. deksel	B	247,11	299,00
	WTANK60C	60 ltr drinkwatertank40 ltr incl. aansluitingen en insp. Deksel	B	263,64	319,00
	WTANK80C	80 ltr drinkwatertank40 ltr incl. aansluitingen en insp. deksel	B	288,43	349,00

DRINKWATERSYSTEMEN

	DWSC04212	Drink watertanksysteem "Comfort", 42 liter, 12 Volt, incl. gemont. pomp en onderdelen.	A	354,55	429,00
	DWSC04224	Drink watertanksysteem "Comfort", 42 liter, 24 Volt, incl. gemont. pomp en onderdelen.	A	354,55	429,00
	DWSC06112	Drink watertanksysteem "Comfort", 61 liter, 12 Volt, incl. gemont. pomp en onderdelen.	A	362,81	439,00
	DWSC06124	Drink watertanksysteem "Comfort", 61 liter, 24 Volt, incl. gemont. pomp en onderdelen.	A	362,81	439,00
	DWSC08812	Drink watertanksysteem "Comfort", 88 liter, 12 Volt, incl. gemont. pomp en onderdelen.	A	404,13	489,00
	DWSC08824	Drink watertanksysteem "Comfort", 88 liter, 24 Volt, incl. gemont. pomp en onderdelen.	A	404,13	489,00
	DWSC12012	Drink watertanksysteem "Comfort", 120 liter, 12 Volt, incl. gemont. pomp en onderdelen.	A	437,19	529,00
	DWSC12024	Drink watertanksysteem "Comfort", 120 liter, 24 Volt, incl. gemont. pomp en onderdelen.	A	437,19	529,00

FLEXIBELE WATERTANKS

167	TANKW55	Watertank 55 ltr (incl.haakse slangaansluiting, Ø 16 en Ø 38 mm)	A	119,01	144,00
	TANKW70	Watertank 70 ltr (incl.haakse slangaansluiting, Ø 16 en Ø 38 mm)	A	127,27	154,00
	TANKW100	Watertank 100 ltr (incl.haakse slangaansluiting, Ø 16 en Ø 38 mm)	A	138,02	167,00
	TANKW160	Watertank 160 ltr (incl.haakse slangaansluiting, Ø 16 en Ø 38 mm)	A	180,17	218,00
	TANKW220	Watertank 220 ltr (incl.haakse slangaansluiting, Ø 16 en Ø 38 mm)	A	214,05	259,00
	TANKW1003	Watertank driehoekig 100 ltr(incl.haakse slangaansluiting, Ø 16 en Ø 38 mm)	A	230,58	279,00

BOILERS

168	WHT025	Boiler met dubbele warmtewisselaar, 25 liter	A	544,63	659,00
	WHT050	Boiler met dubbele warmtewisselaar, 50 liter	A	643,80	779,00
	WHT075	Boiler met dubbele warmtewisselaar, 75 liter	A	751,24	909,00
	WHT100	Boiler met dubbele warmtewisselaar, 100 liter	A	858,68	1039,00
169	WHD020	Dubbelwandige boiler, 20 liter	A	643,80	779,00
	WHD031	Dubbelwandige boiler, 31 liter	A	693,39	839,00
	WHD045	Dubbelwandige boiler, 45 liter	A	751,24	909,00
	WHD055	Dubbelwandige boiler, 55 liter	A	858,68	1039,00
	WHD075	Dubbelwandige boiler, 75 liter	A	966,12	1169,00
Nieuw!	WHDKIT	Aansluitset voor dubbelwandige boilers	ST	30,54	36,95

WATERDRUKSYSTEMEN

170	HF1208	Hydrophoor 12 Volt, inhoud druktank 8 liter	A	495,04	599,00
	HF2408	Hydrophoor 24 Volt, inhoud druktank 8 liter	A	486,78	589,00
	HF1219	Hydrophoor 12 Volt, inhoud druktank 19 liter	A	569,42	689,00
	HF2419	Hydrophoor 24 Volt, inhoud druktank 19 liter	A	577,69	699,00
	HYDRF12	Hydrophoor 12 Volt, inhoud druktank 8 liter incl. drukschakelaar	A	643,80	779,00
	HYDRF24	Hydrophoor 24 Volt, inhoud druktank 8 liter incl. drukschakelaar	A	643,80	779,00
	HYDRF1219	Hydrophoor 12 Volt, inhoud druktank 19 liter incl. drukschakelaar	A	833,88	1009,00
	HYDRF2419	Hydrophoor 24 Volt, inhoud druktank 19 liter incl. drukschakelaar	A	850,41	1029,00

WATERDRUKSYSTEEM POMP

171	WP1208B	Waterdruk pomp 12V - 8ltr/min.	A	85,12	103,00
	WP2408B	Waterdruk pomp 24V - 8ltr/min.	A	85,12	103,00
	WP1213B	Waterdruk pomp 12V - 13ltr/min.	A	95,87	116,00
	WP2413B	Waterdruk pomp 24V - 13ltr/min.	A	95,87	116,00
	WP1220B	Waterdruk pomp 12V - 20ltr/min.	A	108,26	131,00
	WP2420B	Waterdruk pomp 24V - 20ltr/min.	A	108,26	131,00
	EXPAT075	Accumulatortank voor drinkwater, 0,75 liter	A	33,02	39,95

WATERSLANG

172	DWBOSE10B	Drinkwaterslang, inw. Ø 10 mm (Rol van 30 meter, Prijs per meter)	C	5,33	6,45
	DWBOSE12B	Drinkwaterslang, inw. Ø 12 mm (Rol van 30 meter, Prijs per meter)	C	5,33	6,45
	DWBOSE16B	Drinkwaterslang, inw. Ø 16 mm (Rol van 30 meter, Prijs per meter)	C	6,98	8,45
	DWBOSE19B	Drinkwaterslang, inw. Ø 19 mm (Rol van 30 meter, Prijs per meter)	C	10,70	12,95
	DWBOSE25B	Drinkwaterslang, inw. Ø 25 mm (Rol van 30 meter, Prijs per meter)	C	13,18	15,95
	DWBOSE28B	Drinkwaterslang, inw. Ø 28 mm (Rol van 30 meter, Prijs per meter)	C	19,79	23,95
	DWBOSE30B	Drinkwaterslang, inw. Ø 30 mm (Rol van 30 meter, Prijs per meter)	C	16,49	19,95
	DWBOSE32B	Drinkwaterslang, inw. Ø 32 mm (Rol van 30 meter, Prijs per meter)	C	19,79	23,95
	DWBOSE35B	Drinkwaterslang, inw. Ø 35 mm (Rol van 30 meter, Prijs per meter)	C	21,45	25,95
	DWBOSE38B	Drinkwaterslang, inw. Ø 38 mm (Rol van 30 meter, Prijs per meter)	C	21,45	25,95
	DWBOSE40B	Drinkwaterslang, inw. Ø 40 mm (Rol van 10 meter, Prijs per meter)	C	23,10	27,95
	DWBOSE45B	Drinkwaterslang, inw. Ø 45 mm (Rol van 10 meter, Prijs per meter)	C	28,06	33,95
	DWBOSE50B	Drinkwaterslang, inw. Ø 50 mm (Rol van 10 meter, Prijs per meter)	C	28,06	33,95
	HWHOSE13	Warm water en boilerslang, inw. Ø 13 mm (Rol van 10 meter, Prijs per meter)	C	20,62	24,95
	HWHOSE16	Warm water en boilerslang, inw. Ø 16 mm (Rol van 10 meter, Prijs per meter)	C	26,40	31,95

ACCESSOIRES VOOR WATERSYSTEMEN

173	WTK02	Inspectiedeksel voor watertanks	B	14,83	17,95
	WTIKIT	Inspectiedekselkit (incl. pakking, tegenring en bev. materialen) voor watertanks	B	33,02	39,95
	SENSOR280	Universele tankvlotter type Sensor, lengte 280 mm	C	57,85	70,00
	SENSOR320	Universele tankvlotter type Sensor, lengte 320 mm	C	64,46	78,00
	SENSOR380	Universele tankvlotter type Sensor, lengte 380 mm	C	70,25	85,00
	SENSOR480	Universele tankvlotter type Sensor, lengte 480 mm	C	95,87	116,00
	SENSOR580	Universele tankvlotter type Sensor, lengte 580 mm	C	114,88	139,00
	SENSOR680	Universele tankvlotter type Sensor, lengte 680 mm	C	127,27	154,00
	SENSOR780	Universele tankvlotter type Sensor, lengte 780 mm	C	133,88	162,00
	174	WTKIT	Aansluitkit voor watertanks	B	74,38
ILT120F		Inspectiedeksel 120 mm voor drinkwater tanks	A	69,42	84,00
WRILT		Moersleutel voor ILT120	A	7,40	8,95
VSAW159		Ø159 mm gatenzaag voor FTL. Voor kunststof, Polyester of metalen tanks	A	22,27	26,95
ILTCOND		ILT aansluitset voor drinkwater	A	53,72	65,00
ILTCON90		Slangaansluiting G1-1/4 38 mm gebogen	A	14,01	16,95
175	WTS44513B	Aanzuigbuis voor drinkwater tanks 13 mm	B	42,98	52,00
	WHEL22500	Elektrisch verwarmingselement 230 Volt, 500 Watt met thermostaat	ST	71,07	86,00
	WHEL220	Elektrisch verwarmingselement 230 Volt, 1000 Watt met thermostaat	ST	71,07	86,00
	WHEL110	Elektrisch verwarmingselement 110 Volt, 1000 Watt met thermostaat	ST	71,07	86,00
	WHEL1500	Elektrisch verwarmingselement 230 Volt, 1500 Watt met thermostaat (standaard meegeleverd bij VETUS boilers)	ST	71,07	86,00
	WHMIXER	Thermostaatset voor boilers	A	99,17	120,00



VUILWATERSYSTEMEN

ELEKTRISCHE SCHEEPSTOILETTEN

181	TMW12Q	Toilet type TMW, 12 Volt, zonder bediening	A	495,04	599,00
	TMW24Q	Toilet type TMW, 24 Volt, zonder bediening	A	495,04	599,00
182	HATO212B	Toilet type HATO, 12 Volt, met electronisch bedieningspaneel	A	1.321,49	1599,00
	HATO224B	Toilet type HATO, 24 Volt, met electronisch bedieningspaneel	A	1.321,49	1599,00
	HATO110	Toilet type HATO, 120 Volt, 60 Hz, met drukknop bediening	A	1.321,49	1599,00
	HATO220	Toilet type HATO, 230 Volt, 50 Hz, met drukknop bediening	A	1.321,49	1599,00
	WC12S2	Toilet type WCS, 12 Volt, met electronisch bedieningspaneel	A	1.114,88	1349,00
	WC24S2	Toilet type WCS, 24 Volt, met electronisch bedieningspaneel	A	1.114,88	1349,00
	WC110S	Toilet type WCS, 120 Volt, 60 Hz, met drukknop bediening	A	1.114,88	1349,00
	WC220S	Toilet type WCS, 230 Volt, 50 Hz, met drukknop bediening	A	1.114,88	1349,00
183	SMT0212	Toilet type SMT02, 12 Volt, met electronisch bedieningspaneel	A	1.065,29	1289,00
	SMT0224	Toilet type SMT02, 24 Volt, met electronisch bedieningspaneel	A	1.065,29	1289,00
	SMT02S12	Toilet type SMT02, 12 Volt, met tuimelschakelaar bediening	A	776,03	939,00
	SMT02S24	Toilet type SMT02, 24 Volt, met tuimelschakelaar bediening	A	776,03	939,00
	WCP12	Toilet type WCP, 12 Volt, met electronisch bedieningspaneel	A	1.139,67	1379,00
	WCP24	Toilet type WCP, 24 Volt, met electronisch bedieningspaneel	A	1.139,67	1379,00
	WCPS12	Toilet type WCP, 12 Volt, met tuimelschakelaar	A	734,71	889,00
	WCPS24	Toilet type WCP, 24 Volt, met tuimelschakelaar	A	734,71	889,00
	184	TMWBP	Electronisch bedieningspaneel voor toilet type TMWQ/TMS, 12 / 24 Volt	A	77,69
TMWBS		Tuimelschakelaar voor toilet type TMWQ/TMS, 12 / 24 Volt	A	51,24	62,00
SET0137		Bedieningspaneelset voor WCS-L/SMT0/HATO type 2	ST	135,54	164,00
SET0212		Tuimelschakelaarset voor WCPS + SMT02S	ST	73,55	89,00

SANI-PROCESSOR

185	SAPRO12	Sani-processor 12 Volt	A	875,21	1059,00
	SAPRO24	Sani-processor 24 Volt	A	875,21	1059,00
	SAPRO220	Sani-processor 230 Volt, 50 Hz	A	875,21	1059,00

GRIJSWATER AFVOER SYSTEEM

186	GWDS12	Grijswater afvoer systeem, 12 Volt	A	668,60	809,00
	GWDS24	Grijswater afvoer systeem, 24 volt	A	668,60	809,00
	GWDS220	Grijswater afvoer systeem, 230 volt, 50 Hz	A	668,60	809,00
	GWDS110	Grijswater afvoer systeem, 120 volt, 60 Hz	A	668,60	809,00

VASTE TANKS VOOR VUILWATER (INCL. AANSLUITINGEN)

ATANK042	42 ltr Vuilwatertank (exclusief aansluitkit)	A	95,87	116,00
ATANK061	61 ltr Vuilwatertank(exclusief aansluitkit)	A	111,57	135,00
ATANK088	88 ltr Vuilwatertank (exclusief aansluitkit)	A	151,24	183,00
ATANK110	110 ltr Vuilwatertank (exclusief aansluitkit)	A	177,69	215,00
ATANK137	137 ltr Vuilwatertank(exclusief aansluitkit)	A	214,05	259,00
ATANK170	170 ltr Vuilwatertank (exclusief aansluitkit)	A	247,11	299,00
ATANK215	215 ltr Vuilwatertank(exclusief aansluitkit)	A	313,22	379,00
ATANK335	335 ltr Vuilwatertank(exclusief aansluitkit)	A	486,78	589,00
ATANK390	390 ltr Vuilwatertank(exclusief aansluitkit)	A	544,63	659,00







BTANK25C	Vuilwatertank25 ltr, incl. aansluitingen en insp. deksel (excl. vulnippel)	B	204,13	247,00
BTANK40C	Vuilwatertank40 ltr, incl. aansluitingen en insp. deksel (excl. vulnippel)	B	230,58	279,00
BTANK60C	Vuilwatertank60 ltr, incl. aansluitingen en insp. deksel (excl. vulnippel)	B	255,37	309,00
BTANK80C	Vuilwatertank80 ltr, incl. aansluitingen en insp. deksel (excl. vulnippel)	B	280,17	339,00

VUILWATERTANKS VOOR WANDBEVESTIGING





188	WW25WH	Vuilwatertank, horizontaal, 25 liter voor wandbevestiging, compleet	B	296,69	359,00
	WW25W	Vuilwatertank 25 liter voor wandbevestiging, compleet	B	296,69	359,00
	WW60W	Vuilwatertank 60 liter voor wandbevestiging, compleet	B	329,75	399,00
	WW80W	Vuilwatertank 80 liter voor wandbevestiging, compleet	B	354,55	429,00

COMPLEET VUILWATERTANKSYSTEEM











189	WWS4212B	Vuilwatertanksysteem 42 liter, 12 Volt, incl. pomp, vlotter en afzuigbuis (excl. fittingen)	A	784,30	949,00
	WWS4224B	Vuilwatertanksysteem 42 liter, 24 volt, incl. pomp, vlotter en afzuigbuis (excl. fittingen)	A	784,30	949,00
	WWS6112B	Vuilwatertanksysteem 61 liter, 12 Volt, incl. pomp, vlotter en afzuigbuis (excl. fittingen)	A	825,62	999,00
	WWS6124B	Vuilwatertanksysteem 61 liter, 24 volt, incl. pomp, vlotter en afzuigbuis (excl. fittingen)	A	825,62	999,00

WWS8812B	Vuilwatertanksysteem 88 liter, 12 Volt, incl. pomp, vlotter en afzuigbuis (excl. fittingen)	A	850,41	1029,00	
WWS8824B	Vuilwatertanksysteem 88 liter, 24 volt, incl. pomp, vlotter en afzuigbuis (excl. fittingen)	A	850,41	1029,00	
WWS12012B	Vuilwatertanksysteem 120 liter, 12 Volt, incl. pomp, vlotter en afzuigbuis (excl. fittingen)	A	916,53	1109,00	
WWS12024B	Vuilwatertanksysteem 120 liter, 24 volt, incl. pomp, vlotter en afzuigbuis (excl. fittingen)	A	916,53	1109,00	
APT100	Multifunctionele tank, 100 liter	A	238,84	289,00	
VTSTRAP	VETUS spanband, 2 stuks 3m x 25 mm met VETUS logo	A	10,70	12,95	

FLEXIBELE TANKS VOOR VUILWATER

190	TANKV55	Vuilwatertank 55 ltr (incl. haakse slangaansluiting Ø 16 en Ø 38 mm)	C	222,31	269,00	
	TANKV70	Vuilwatertank 70 ltr (incl. haakse slangaansluiting Ø 16 en Ø 38 mm)	C	313,22	379,00	
	TANKV100	Vuilwatertank 100 ltr (incl. haakse slangaansluiting Ø 16 en Ø 38 mm)	C	329,75	399,00	
	TANKV160	Vuilwatertank 160 ltr (incl. haakse slangaansluiting Ø 16 en Ø 38 mm)	C	470,25	569,00	



GEURFILTERS

	NSF16S	Geurfilter klein, met aansluitingen voor Ø 16 mm slang	C	92,56	112,00	
	NSF16	Geurfilter groot, met aansluitingen voor Ø 16 mm slang	C	116,53	141,00	
	NSF19	Geurfilter groot, met aansluitingen voor Ø 19 mm slang	C	116,53	141,00	
	NSF25	Geurfilter groot, met aansluitingen voor Ø 25 mm slang	C	116,53	141,00	
	NSF38	Geurfilter groot, met aansluitingen voor Ø 38 mm slang	C	116,53	141,00	
	NSF16FE	Reservefilter voor geurfilter groot model	C	24,75	29,95	
	NSF16FES	Reserve filter voor geurfilter klein model	C	14,83	17,95	
	NSFCAN	Vervangings filterbussen met dubbele functie voor geurfilters type NSF	B	33,02	39,95	
	NSFCANS	Vervangings filterbussen met dubbele functie voor geurfilters type NSF_S	B	25,58	30,95	
	TFRESH05	TankFresh, middel tegen nare geurtjes, 500 ml doseer flesje	A	19,79	23,95	











TOEBEHOREN VOOR VUILWATERTANKS

191	WWSensorA	Vuilwater tankvlotter 12/24 Volt	C	178,51	216,00	
	WWCP	Controlepaneel voor vuilwater	C	412,40	499,00	







VUILWATER-/LENSPOMP

	EMP14012B	Vuilwater/ lenspomp 12V/ slangaansl. 38 mm, roteerbaar (ca. 27 l/min.)	B	338,02	409,00	
	EMP14024B	Vuilwater/ lenspomp 24V/ slangaansl. 38 mm, roteerbaar (ca. 27 l/min.)	B	338,02	409,00	



APPENDAGES













192	VRF56A	Vacuumventiel Ø 56 mm voor vuilwatertanks	C	33,84	40,95	
	RT13B	Slangaansluiting, Ø 13L mm, haaks t.b.v. vaste tanks	C	19,79	23,95	
	RT16B	Slangaansluiting, Ø 16 mm, haaks t.b.v. vaste tanks	C	19,79	23,95	
	RT19B	Slangaansluiting, Ø 19 mm, haaks t.b.v. vaste tanks	C	19,79	23,95	
	RT25B	Slangaansluiting, Ø 25 mm, haaks t.b.v. vaste tanks	C	19,79	23,95	
	RT38B	Slangaansluiting, Ø 38 mm, haaks t.b.v. vaste tanks	C	19,79	23,95	
	FT13B	Slangaansluiting, Ø 13 mm, haaks t.b.v. flexibele tanks	C	19,79	23,95	
	FT16B	Slangaansluiting, Ø 16 mm, haaks t.b.v. flexibele tanks	C	19,79	23,95	
	FT19B	Slangaansluiting, Ø 19 mm, haaks t.b.v. flexibele tanks	C	19,79	23,95	
	FT25B	Slangaansluiting, Ø 25 mm, haaks t.b.v. flexibele tanks	C	19,79	23,95	
	FT38B	Slangaansluiting, Ø 38 mm, haaks t.b.v. flexibele tanks	C	19,79	23,95	
	BTKIT	Kit voor vuilwatertank, excl. afzuigbuis	B	46,28	56,00	
	BV11/2L	Kogelkraan roestvast staal, G1½, met afsluitvergrendeling	Q	110,74	134,00	







VERBINDINGS-/REDUCEERSTUKKEN (OP MAAT AF TE ZAGEN)

193	HA1338	Kunststof slangtule Ø 13 - 38 mm	C	19,79	23,95	
	HA3060	Kunststof slangtule Ø 30 - 60 mm	C	27,23	32,95	
	ILT120F	Inspectiedeksel 120 mm voor drinkwater tanks	A	69,42	84,00	
	ILTCONW	ILT aansluitset voor vuilwater	A	51,24	62,00	
	ILTCON90	Slangaansluiting G1-1/4 38 mm gebogen	A	14,01	16,95	
	WRILT	Moersleutel voor ILT120	A	7,40	8,95	
	VSAW159	Ø159 mm gatenzaag voor FTL. Voor kunststof, Polyester of metalen tanks	A	22,27	26,95	





ELEKTRISCH BEDIENBARE KOGELKRANEN

194	MV12A1/2	elektrisch bedienbare kogelkraan 12 Volt, 1/2"	A	569,42	689,00	
	MV12A3/4	elektrisch bedienbare kogelkraan 12 Volt, 3/4"	A	594,21	719,00	
	MV12A1	elektrisch bedienbare kogelkraan 12 Volt, 1"	A	627,27	759,00	
	MV12A11/4	elektrisch bedienbare kogelkraan 12 Volt, 1 1/4"	A	676,86	819,00	
	MV12A11/2	elektrisch bedienbare kogelkraan 12 Volt, 1 1/2"	A	726,45	879,00	
	MV24A1/2	elektrisch bedienbare kogelkraan 24 Volt, 1/2"	A	569,42	689,00	
	MV24A3/4	elektrisch bedienbare kogelkraan 24 Volt, 3/4"	A	594,21	719,00	
	MV24A1	elektrisch bedienbare kogelkraan 24 Volt, 1"	A	627,27	759,00	









	MV24A11/4	elektrisch bedienbare kogelkraan 24 Volt, 11/4"	A	676,86	819,00
	MV24A11/2	elektrisch bedienbare kogelkraan 24 Volt, 11/2"	A	726,45	879,00
	MV24B2	elektrisch bedienbare kogelkraan 24 Volt, 2"	A	1.114,88	1349,00
	WTS78038S	Afzuigbuis vuilwatertank, L=780 mm, slangnippel Ø 38 mm, recht	B	40,45	48,95
	WTS78038B	Afzuigbuis vuilwatertank, L=780 mm, slangnippel Ø 38 mm, haaks	B	42,98	52,00
	Nieuw! ELVPAN12	Paneel 12 Volt voor elektrisch bedienbare kogelkraan MV	SV	57,02	69,00
	Nieuw! ELVPAN24	Paneel 24 Volt voor elektrisch bedienbare kogelkraan MV	SV	57,02	69,00
	WWCP	Paneel voor vuilwater systemen	C	412,40	499,00
	EIP12	Elektrische impeller pomp 12V	A	140,50	170,00
VUILWATERSLANG (GRIJS WATER)					
	WWHOSE16B	Vuilwaterslang (grijs water), inw. Ø 16 mm (Rol van 30 meter, Prijs per meter)	C	5,33	6,45
	WWHOSE19B	Vuilwaterslang (grijs water), inw. Ø 19 mm (Rol van 30 meter, Prijs per meter)	C	9,05	10,95
	WWHOSE25B	Vuilwaterslang (grijs water), inw. Ø 25 mm (Rol van 30 meter, Prijs per meter)	C	9,05	10,95
	WWHOSE38B	Vuilwaterslang (grijs water), inw. Ø 38 mm (Rol van 30 meter, Prijs per meter)	C	20,62	24,95
	WWHOSE45B	Vuilwaterslang (grijs water), inw.Ø 45 mm (Rol van 10 meter, Prijs per meter)	C	24,75	29,95
GEURDICHTE WATERSLANG					
	SAHOSE16	Geurdichte vuilwaterslang inw.Ø 16 mm (Rol van 20 meter, Prijs per meter)	C	15,66	18,95
	SAHOSE19	Geurdichte vuilwaterslang inw.Ø 19 mm (Rol van 20 meter, Prijs per meter)	C	16,49	19,95
	SAHOSE25	Geurdichte vuilwaterslang inw.Ø 25 mm (Rol van 20 meter, Prijs per meter)	C	20,62	24,95
	SAHOSE38	Geurdichte vuilwaterslang inw.Ø 38 mm (Rol van 20 meter, Prijs per meter)	C	26,40	31,95
	WTK02	Inspectiedeksel voor watertanks	B	14,83	17,95
	ASD38H	Beluchter type ASD 38 mm, met slang	C	103,31	125,00
	196 Y3V	Kunststof 3 weg-klep	A	74,38	90,00
	Y3C	Kunststof "Y" connector	A	25,58	30,95
	YNRE	Kunststof terugslagklep	A	13,18	15,95
	YPA38P2	Slangaansluiting 38 mm (2 stuks)	A	6,16	7,45
	YPA38P1	Slangaansluiting 38 mm (1 stuk)	A	3,80	4,60
	YPA32P2	Slangaansluiting 32 mm (2 stuks)	A	6,16	7,45
	YPA32P1	Slangaansluiting 32 mm (1 stuk)	A	3,80	4,60
	YPA28P2	Slangaansluiting 28 mm (2 stuks)	A	6,16	7,45
	YPA28P1	Slangaansluiting 28 mm (1 stuk)	A	3,80	4,60
	YPA25P2	Slangaansluiting 25 mm (2 stuks)	A	6,16	7,45
	YPA25P1	Slangaansluiting 25 mm (1 stuk)	A	3,80	4,60
	YPA19P2	Slangaansluiting 19 mm (2 stuks)	A	6,16	7,45
	YPA19P1	Slangaansluiting 19 mm (1 stuk)	A	3,80	4,60
BOEGSCHROEFSYSTEMEN					
BOEG- EN HEKSCHROEVEN (ELEKTRISCH)					
(excl. paneel en tussenkabel)					
STANDAARD BOEGSCHROEVEN					
	203 BOW2512E	Boegschroef 25 kgf, 12 Volt, tunneldiameter 110 mm.	A	990,91	1199,00
	BOW3512E	Boegschroef 35 kgf, 12 Volt, tunneldiameter 150 mm.	A	1.065,29	1289,00
	BOW3512F	Boegschroef 35 kgf, 12 Volt, tunneldiameter 125 mm.	A	1.065,29	1289,00
	BOW4012	Boegschroef 40 kgf, 12 Volt, tunneldiameter 140 mm.	A	1.197,52	1449,00
	BOW4512D	Boegschroef 45 kgf, 12 Volt, tunneldiameter 125 mm.	A	1.338,02	1619,00
	BOW5512D	Boegschroef 55 kgf, 12 Volt, tunneldiameter 150 mm.	A	1.693,39	2049,00
	BOW5524D	Boegschroef 60 kgf, 24 Volt, tunneldiameter 150 mm.	A	1.734,71	2099,00
	BOW6012D	Boegschroef 60 kgf, 12 Volt, tunneldiameter 185 mm.	A	1.817,36	2199,00
	BOW6024D	Boegschroef 70 kgf, 24 Volt, tunneldiameter 185 mm.	A	1.776,03	2149,00
	BOW7512D	Boegschroef 80 kgf, 12 Volt, tunneldiameter 185 mm.	A	2.147,93	2599,00
	BOW7524D	Boegschroef 85 kgf, 24 Volt, tunneldiameter 185 mm.	A	2.147,93	2599,00
	BOW9512D	Boegschroef 95 kgf, 12 Volt, tunneldiameter 185 mm.	A	3.057,02	3699,00
	BOW9524D	Boegschroef 105 kgf, 24 Volt, tunneldiameter 185 mm.	A	3.057,02	3699,00
	BOW12512D	Boegschroef 125 kgf, 12 Volt, tunneldiameter 250 mm.	A	3.594,21	4349,00
	BOW12524D	Boegschroef 140 kgf, 24 volt, tunneldiameter 250 mm.	A	3.594,21	4349,00
	BOW16024D	Boegschroef 160 kgf, 24 Volt, tunneldiameter 250 mm.	A	4.503,31	5449,00
	BOW18024D	Boegschroef 180 kgf, 24 Volt, tunneldiameter 250 mm.	A	4.709,92	5699,00
	BOW22024D	Boegschroef 220 kgf, 24 Volt, tunneldiameter 300 mm.	A	5.825,62	7049,00
	BOW28548D	Boegschroef 285 kgf, 48 Volt, tunneldiameter 300 mm.	A	7.271,90	8799,00
	BOW2512EK	Complete boegschroefset incl. BOW2512E, BP110G75, BPSE2, BP29, zekering en zekeringhouder	A	1.222,31	1479,00
	BOW3512EK	Complete boegschroefset incl. BOW3512E, BP150G75, BPSE2, BP29, zekering en zekeringhouder	A	1.321,49	1599,00

BOW3512FK	Complete boegschroefset incl. BOW3512F, BP125G75, BPSE2, BP29, zekering en zekeringhouder	A	1.321,49	1599,00	
BOW4012DK	Complete boegschroefset incl. BOW4012, BP140G75, BPSE2, BP29, zekering en zekeringhouder	A	1.453,72	1759,00	
BOW4512DK	Complete boegschroefset incl. BOW4512D, BP125G75, BPSE2, BP29, zekering en zekeringhouder	A	1.652,07	1999,00	
BOW5512DK	Complete boegschroefset incl. BOW5512D, BP150G75, BPSE2, BP2910, zekering en zekeringhouder	A	1.982,64	2399,00	
BOW6012DK	Complete boegschroefset incl. BOW6012D, BP185G75, BPSE2, BP2910, zekering en zekeringhouder	A	2.189,26	2649,00	
BOW7512DK	Complete boegschroefset incl. BOW7512D, BP185G75, BPSE2, BP2910, zekering en zekeringhouder	A	2.561,16	3099,00	

Reserve propellers (6 blads) voor boegschroeven

204	SET0086	Propeller 6 blad, diameter Ø 110 mm., voor boegschroef 25 kgf	SV	71,90	87,00	
	SET0225	Propeller 6 blad, diameter Ø 125 mm., voor boegschroef 35/45 kgf	SV	77,69	94,00	
	SET0087	Propeller 6 blad, diameter Ø 150 mm., voor boegschroef 35/55 kgf	SV	85,12	103,00	
	SET0088	Propeller 6 blad, diameter Ø 185 mm., voor boegschroef 55/60/75/95 kgf	SV	108,26	131,00	
	SET0089	Propeller 6 blad, diameter Ø 185 mm., voor boegschroef 45/50/80 kgf ⁻¹⁹⁸	SV	108,26	131,00	
	SET0090	Propeller 6 blad, diameter Ø 250 mm., voor boegschroef 125/130/160 kgf	SV	185,12	224,00	
	SET0171	Propeller 6 blad, diameter Ø 295 mm., voor boegschroef 220/285/230/310 kgf	SV	200,00	242,00	

BOW PRO BOEGSCHROEVEN

206	BOWA0301	BOW PRO volledige proportionele borstelloze thruster 30kgf, tunnel Ø 110 mm	A	1.941,32	2349,00	
	BOWA0361	BOW PRO volledige proportionele borstelloze thruster 36kgf, tunnel Ø 125 mm	A	2.065,29	2499,00	
	BOWA0421	BOW PRO volledige proportionele borstelloze thruster 42kgf, tunnel Ø 125 mm	A	2.189,26	2649,00	
	BOWA0571	BOW PRO volledige proportionele borstelloze thruster 57kgf, tunnel Ø 150 mm	A	2.313,22	2799,00	
	BOWA0651	BOW PRO volledige proportionele borstelloze thruster 65kgf, tunnel Ø 185 mm	A	2.437,19	2949,00	
	BOWA0761	BOW PRO volledige proportionele borstelloze thruster 76kgf, tunnel Ø 185 mm	A	2.809,09	3399,00	
	BOWKIT30	Complete boegschroefset incl. BOWA0301, BP110G75, BPPPA, BPROASET, zekering en zekeringhouder	A	2.478,51	2999,00	
	BOWKIT36	Complete boegschroefset incl. BOWA0361, BP125G75, BPPPA, BPROASET, zekering en zekeringhouder	A	2.561,16	3099,00	
	BOWKIT42	Complete boegschroefset incl. BOWA0421, BP150G75, BPPPA, BPROASET, zekering en zekeringhouder	A	2.726,45	3299,00	

BOW PRO BOOSTED BOEGSCHROEVEN

	BOWB057	BOW PRO Boosted volledige proportionele borstelloze thruster 57kgf, 12 V & 24 V, tunnel Ø 150 mm	A	2.437,19	2949,00	
	BOWB065	BOW PRO Boosted volledige proportionele borstelloze thruster 65kgf, 12 V & 24 V, tunnel Ø 185 mm	A	2.561,16	3099,00	
	BOWB076	BOW PRO Boosted volledige proportionele borstelloze thruster 76kgf, 12 V & 24 V, tunnel Ø 185 mm	A	2.933,06	3549,00	
	BOWB090	BOW PRO Boosted volledige proportionele borstelloze thruster 90kgf, 12 V & 24 V, tunnel Ø 185 mm	A	3.635,54	4399,00	
	BOWB110	BOW PRO Boosted volledige proportionele borstelloze thruster 110kgf, 12 V & 24 V, tunnel Ø 185 mm	A	4.131,40	4999,00	
	BOWB130	BOW PRO Boosted volledige proportionele borstelloze thruster 130kgf, 12 V & 24 V, tunnel Ø 185 mm	A	4.503,31	5449,00	
207	BOWB150	BOW PRO Boosted volledige proportionele borstelloze thruster 150kgf, 12 V & 24 V, tunnel Ø 250 mm	A	4.833,88	5849,00	
	BOWB180	BOW PRO Boosted volledige proportionele borstelloze thruster 180kgf, 24 V & 48 V, tunnel Ø 250 mm	A	5.288,43	6399,00	
	BOWB210	BOW PRO Boosted volledige proportionele borstelloze thruster 210kgf, 24 V & 48 V, tunnel Ø 250 mm	A	5.784,30	6999,00	
Nieuw!	BOWB285	BOW PRO Boosted volledige proportionele borstelloze thruster 285kgf, 24 V & 48 V, tunnel Ø 300 mm	A	6.321,49	7649,00	
Nieuw!	BOWB300	BOW PRO Boosted volledige proportionele borstelloze thruster 300kgf, 24 V & 48 V, tunnel Ø 300 mm	A	6.858,68	8299,00	
Nieuw!	BOWB320	BOW PRO Boosted volledige proportionele borstelloze thruster 320kgf, 24 V & 48 V, tunnel Ø 300 mm	A	7.354,55	8899,00	
Nieuw!	BOWB370	BOW PRO Boosted volledige proportionele borstelloze thruster 370kgf, 24 V & 48 V, tunnel Ø 400 mm	A	7.850,41	9499,00	
Nieuw!	BOWB420	BOW PRO Boosted volledige proportionele borstelloze thruster 420kgf, 24 V & 48 V, tunnel Ø 400 mm	A	8.387,60	10149,00	
	BOWKIT57	Complete boegschroefset incl. BOWB057, BP150G75, BPPPA, BPROBSET, zekering en zekeringhouder	A	2.974,38	3599,00	
	BOWKIT65	Complete boegschroefset incl. BOWB065, BP185G75, BPPPA, BPROBSET, zekering en zekeringhouder	A	3.057,02	3699,00	
	BOWKIT76	Complete boegschroefset incl. BOWB076, BP185G75, BPPPA, BPROBSET, zekering en zekeringhouder	A	3.470,25	4199,00	
	BOWKIT90	Complete boegschroefset incl. BOWB090, BP185G75, BPPPA, BPROBSET, zekering en zekeringhouder	A	4.214,05	5099,00	
	BPROASET	Aansluitset for BOW PRO (BOWA)	A	190,08	230,00	
	BPROBSET	Aansluitset for BOW PRO Boosted (BOWB)	A	139,67	169,00	

BOW PRO 48V BOEGSCHROEVEN

	BOWA0304	BOW PRO volledige proportionele borstelloze thruster 30kgf, tunnel Ø 110 mm	A	2.189,26	2649,00	
	BOWA0364	BOW PRO volledige proportionele borstelloze thruster 36kgf, tunnel Ø 125 mm	A	2.313,22	2799,00	
	BOWA0574	BOW PRO volledige proportionele borstelloze thruster 57kgf, tunnel Ø 150 mm	A	2.437,19	2949,00	
	BOWA0764	BOW PRO volledige proportionele borstelloze thruster 76kgf, tunnel Ø 185 mm	A	2.933,06	3549,00	

Reserve propellers (6 blads) voor BOW PRO boegschroeven

208	DM80017	Propeller 6 blad, diameter Ø 110 mm., blauw, voor 30 kgf BOW PRO boegschroef	SV	71,90	87,00	
	DM80018	Propeller 6 blad, diameter Ø 125 mm., blauw, voor 36/42 kgf BOW PRO boegschroef	SV	77,69	94,00	

Nieuw!	DM80019	Propeller 6 blad, diameter Ø 150 mm., blauw, voor 55/57 kgf BOW PRO boegschroef	SV	85,12	103,00
	DM80020	Propeller 6 blad, diameter Ø 185 mm., blauw, voor 65/76/90/110/130 kgf BOW PRO boegschroef	SV	108,26	131,00
	DM80021	Propeller 6 blad, diameter Ø 250 mm., blauw, voor 150/180/210 kgf BOW PRO boegschroef	SV	185,12	224,00
	DM80036	Propeller 6 blad, diameter Ø 300 mm., blauw, voor 285/300/320 kgf BOW PRO boegschroef	SV	200,00	242,00
	BOWHPCK	Aansluitset voor hoge Amperages	A	64,46	78,00

RIMDRIVE

209	RD125	Boegschroef, 125 kgf, tunnel met een diameter van 250 mm	K	6.900,00	8349,00
	RD160	Boegschroef, 160 kgf, tunnel met een diameter van 250 mm	K	7.726,45	9349,00

EXTENDED RUNTIME" BOEGSCHROEVEN

210	BOW954DE	"Extended runtime" boegschroef 105 kgf, 24 Volt, tunneldiameter 185 mm.	A	3.470,25	4199,00
	BOW1254DE	"Extended runtime" boegschroef 140 kgf, 24 volt, tunneldiameter 250 mm.	A	4.048,76	4899,00
	BOW1604DE	"Extended runtime" boegschroef 160 kgf, 24 Volt, tunneldiameter 250 mm.	A	5.205,79	6299,00
	BOW2204DE	"Extended runtime" boegschroef 220 kgf, 24 Volt, tunneldiameter 300 mm.	A	6.528,10	7899,00

IP65 BOEGSCHROEVEN

211	BOW2512EI	IP65 Boegschroef 25 kgf, 12 Volt, tunneldiameter 110 mm.	A	1.139,67	1379,00
	BOW3512EI	IP65 Boegschroef 35 kgf, 12 Volt, tunneldiameter 150 mm.	A	1.230,58	1489,00
	BOW3512FI	IP65 Boegschroef 35 kgf, 12 Volt, tunneldiameter 125 mm.	A	1.230,58	1489,00
	BOW4512DI	IP65 Boegschroef 45 kgf, 12 Volt, tunneldiameter 125 mm.	A	1.776,03	2149,00
	BOW5512DI	IP65 Boegschroef 55 kgf, 12 Volt, tunneldiameter 150 mm.	A	1.982,64	2399,00
	BOW5524DI	IP65 Boegschroef 60 kgf, 24 Volt, tunneldiameter 150 mm.	A	1.982,64	2399,00
	BOW7512DI	IP65 Boegschroef 80 kgf, 12 Volt, tunneldiameter 185 mm.	A	2.809,09	3399,00
	BOW7524DI	IP65 Boegschroef 85 kgf, 24 Volt, tunneldiameter 185 mm.	A	2.809,09	3399,00
	BOW9512DI	IP65 Boegschroef 95 kgf, 12 Volt, tunneldiameter 185 mm.	A	3.924,79	4749,00
	BOW9524DI	IP65 Boegschroef 105 kgf, 24 Volt, tunneldiameter 185 mm.	A	3.924,79	4749,00
	BOW1252DI	IP65 Boegschroef 125 kgf, 12 Volt, tunneldiameter 250 mm.	A	4.792,56	5799,00
	BOW1254DI	IP65 Boegschroef 125 kgf, 24 volt, tunneldiameter 250 mm.	A	4.792,56	5799,00
	BOW1604DI	IP65 Boegschroef 160 kgf, 24 volt, tunneldiameter 250 mm.	A	4.627,27	5599,00

INKLAPBARE BOEGSCHROEVEN

213	STE5512D	Inklapbare elektrische 12 V boegschroef, 55 kgf	A	5.371,07	6499,00
	STE5524D	Inklapbare elektrische 24 V boegschroef, 55 kgf	A	5.371,07	6499,00
	STE6012D	Inklapbare elektrische 12 V boegschroef, 60 kgf	A	6.073,55	7349,00
	STE6024D	Inklapbare elektrische 24 V boegschroef, 60 kgf	A	6.073,55	7349,00
	STE7512D	Inklapbare elektrische 12 V boegschroef, 75 kgf	A	6.280,17	7599,00
	STE7524D	Inklapbare elektrische 24 V boegschroef, 75 kgf	A	6.280,17	7599,00
	STE9512D	Inklapbare elektrische 12 V boegschroef, 95 kgf	A	6.941,32	8399,00
	STE9524D	Inklapbare elektrische 24 V boegschroef, 95 kgf			

Prijs op aanvraag

HYDRAULISCHE BOEG- EN HEKSCHROEVEN



























215	BOW55HMD	Boegschroef Hydraulisch 55 kgf, 3,5 kW, tunneldiam. 150 mm	A	1.643,80	1989,00
	BOW95HMD	Boegschroef Hydraulisch 95 kgf, 6,0 kW, tunneldiam. 185 mm	A	2.023,97	2449,00
	BOW160HMD	Boegschroef Hydraulisch 160 kgf, 12,3 kW, tunneldiam. 250 mm	A	2.726,45	3299,00
	BOW230HMD	Boegschroef Hydraulisch 230 kgf, 16,4 kW, tunneldiam. 300 mm	A	3.759,50	4549,00
	BOW310HMD	Boegschroef Hydraulisch 310 kgf, 26,8 kW, tunneldiam. 300 mm.	A	4.048,76	4899,00
	BOWH410	Boegschroef Hydraulisch 410 kgf, 22 kW, buisdiam. 400 mm.	A	8.470,25	10249,00
	BOWH550	Boegschroef Hydraulisch 550 kgf, 33 kW, buisdiam. 400 mm.	A	8.470,25	10249,00

Reserve propellers (6 blads) voor boegschroeven

	BP1053	Bronzen propeller voor BOW22024/BOW230HM	A	709,92	859,00
	BP3019	Bronzen propeller voor BOW28524	ST	652,07	789,00
	BP1182	Bronzen propeller voor BOW310HM	A	709,92	859,00
	BP1259	Bronzen propeller voor BOW410HM	A	1.015,70	1229,00
	BP1260	Bronzen propeller voor BOW550HM	A	1.015,70	1229,00

BOEGSCHROEFTUNNELS (afwijkende maten op aanvraag leverbaar)

218	BP110G75	Glasvezelversterkte polyester tunnel Ø 110 x 750 mm	A	72,73	88,00
	BP110G10	Glasvezelversterkte polyester tunnel Ø 110 x 1000 mm	A	96,69	117,00
	BP110G15	Glasvezelversterkte polyester tunnel Ø 110 x 1500 mm	A	206,61	250,00
	BP110G20	Glasvezelversterkte polyester tunnel Ø 110 x 2000 mm	A	222,31	269,00
	BP110G30	Glasvezelversterkte polyester tunnel Ø 110 x 3000 mm	A	280,17	339,00
	BP125G75	Glasvezelversterkte polyester tunnel Ø 125 x 750 mm	A	94,21	114,00
	BP125G10	Glasvezelversterkte polyester tunnel Ø 125 x 1000 mm	A	121,49	147,00
	BP125G15	Glasvezelversterkte polyester tunnel Ø 125 x 1500 mm	A	169,42	205,00

	BP125G20	Glasvezelversterkte polyester tunnel Ø 125 x 2000 mm	A	181,82	220,00	
	BP125G30	Glasvezelversterkte polyester tunnel Ø 125 x 3000 mm	A	329,75	399,00	
	BP140G75	Glasvezelversterkte polyester tunnel Ø 140 x 750 mm	A	111,57	135,00	
	BP140G10	Glasvezelversterkte polyester tunnel Ø 140 x 1000 mm	A	148,76	180,00	
	BP140G15	Glasvezelversterkte polyester tunnel Ø 140 x 1500 mm	A	214,05	259,00	
	BP150G75	Glasvezelversterkte polyester tunnel Ø 150 x 750 mm.	A	94,21	114,00	
	BP150G10	Glasvezelversterkte polyester tunnel Ø 150 x 1000 mm	A	123,97	150,00	
	BP150G15	Glasvezelversterkte polyester tunnel Ø 150 x 1500 mm	A	176,03	213,00	
	BP150G20	Glasvezelversterkte polyester tunnel Ø 150 x 2000 mm	A	280,17	339,00	
	BP150G30	Glasvezelversterkte polyester tunnel Ø 150 x 3000 mm	A	329,75	399,00	
	BP185G75	Glasvezelversterkte polyester tunnel Ø 185 x 750 mm	A	155,37	188,00	
	BP185G10	Glasvezelversterkte polyester tunnel Ø 185 x 1000 mm	A	183,47	222,00	
	BP185G15	Glasvezelversterkte polyester tunnel Ø 185 x 1500 mm	A	280,17	339,00	
	BP185G20	Glasvezelversterkte polyester tunnel Ø 185 x 2000 mm	A	338,02	409,00	
	BP185G30	Glasvezelversterkte polyester tunnel Ø 185 x 3000 mm	A	536,36	649,00	
	BP250G10	Glasvezelversterkte polyester tunnel Ø 250 x 1000 mm	A	271,90	329,00	
	BP250G15	Glasvezelversterkte polyester tunnel Ø 250 x 1500 mm	A	395,87	479,00	
	BP250G20	Glasvezelversterkte polyester tunnel Ø 250 x 2000 mm	A	503,31	609,00	
	BP250G25	Glasvezelversterkte polyester tunnel Ø 250 x 2500 mm	A	536,36	649,00	
	BP250G30	Glasvezelversterkte polyester tunnel Ø 250 x 3000 mm	A	602,48	729,00	
	BP300G10	Glasvezelversterkte polyester tunnel Ø 300 x 1000 mm	A	395,87	479,00	
	BP300G15	Glasvezelversterkte polyester tunnel Ø 300 x 1500 mm	A	594,21	719,00	
Nieuw!	BP300G20	Glasvezelversterkte polyester tunnel Ø 300 x 2000 mm	A	635,54	769,00	
Nieuw!	BP300G25	Glasvezelversterkte polyester tunnel Ø 300 x 2500 mm	A	685,12	829,00	
Nieuw!	BP300G30	Glasvezelversterkte polyester tunnel Ø 300 x 3000 mm	A	726,45	879,00	
	BP400G20	Glasvezelversterkte polyester tunnel Ø 400 x 2000 mm	A	742,98	899,00	
	BP400G25	Glasvezelversterkte polyester tunnel Ø 400 x 2500 mm	A	908,26	1099,00	
	BP110S75	Stalen tunnel Ø 110 x 750 mm	A	104,96	127,00	
	BP110S10	Stalen tunnel Ø 110 mm x 1000 mm	A	171,07	207,00	
	BP110S15	Stalen tunnel Ø 110 mm x 1500 mm	A	168,60	204,00	
	BP110S30	Stalen tunnel Ø 110 mm x 3000 mm	A	528,10	639,00	
	BP125S10	Stalen tunnel Ø 125 mm x 1000 mm	A	176,03	213,00	
	BP125S15	Stalen tunnel Ø 125 mm x 1500 mm	A	255,37	309,00	
	BP125S30	Stalen tunnel Ø 125 mm x 3000 mm	A	445,45	539,00	
	BP150S10	Stalen tunnel Ø 150 x 1000 mm	A	164,46	199,00	
	BP150S15	Stalen tunnel Ø 150 x 1500 mm	A	255,37	309,00	
	BP150S20	Stalen tunnel Ø 150 x 2000 mm	A	329,75	399,00	
	BP150S30	Stalen tunnel Ø 150 x 3000 mm	A	461,98	559,00	
	BP185S10	Stalen tunnel Ø 185 x 1000 mm	A	230,58	279,00	
	BP185S15	Stalen tunnel Ø 185 x 1500 mm	A	329,75	399,00	
	BP185S20	Stalen tunnel Ø 185 x 2000 mm	A	461,98	559,00	
	BP185S30	Stalen tunnel Ø 185 x 3000 mm	A	676,86	819,00	
	BP250S10	Stalen tunnel Ø 250 x 1000 mm	A	362,81	439,00	
	BP250S15	Stalen tunnel Ø 250 x 1500 mm	A	544,63	659,00	
	BP250S20	Stalen tunnel Ø 250 x 2000 mm	A	759,50	919,00	
	BP250S25	Stalen tunnel Ø 250 x 2500 mm	A	891,74	1079,00	
	BP250S30	Stalen tunnel Ø 250 x 3000 mm	A	1.123,14	1359,00	
	BP300S10	Stalen tunnel Ø 300 x 1000 mm	A	693,39	839,00	
	BP300S15	Stalen tunnel Ø 300 x 1500 mm	A	1.214,05	1469,00	
Nieuw!	BP300S20	Stalen tunnel Ø 300 x 2000 mm	A	1.296,69	1569,00	
Nieuw!	BP300S25	Stalen tunnel Ø 300 x 2500 mm	A	1.371,07	1659,00	
Nieuw!	BP300S30	Stalen tunnel Ø 300 x 3000 mm	A	2.106,61	2549,00	
	BP400S20	Stalen tunnel Ø 400 x 2000 mm	A	2.561,16	3099,00	
	BP400S25	Stalen tunnel Ø 400 x 2500 mm	A	3.098,35	3749,00	
	BP110A75	Aluminium tunnel Ø 110 x 750 mm	A	85,95	104,00	
	BP110A10	Aluminium tunnel Ø 110 x 1000 mm	A	114,88	139,00	
	BP110A15	Aluminium tunnel Ø 110 x 1500 mm	A	195,04	236,00	
	BP110A30	Aluminium tunnel Ø 110 x 3000 mm	A	338,02	409,00	
	BP125A75	Aluminium tunnel Ø 125 x 750 mm	A	263,64	319,00	
	BP125A10	Aluminium tunnel Ø 125 x 1000 mm	A	296,69	359,00	
	BP125A15	Aluminium tunnel Ø 125 x 1500 mm	A	495,04	599,00	
	BP125A20	Aluminium tunnel Ø 125 x 2000 mm	A	577,69	699,00	
	BP125A30	Aluminium tunnel Ø 125 x 3000 mm	A	833,88	1009,00	
	BP150A10	Aluminium tunnel Ø 150 x 1000 mm	A	190,08	230,00	
	BP150A15	Aluminium tunnel Ø 150 x 1500 mm	A	304,96	369,00	
	BP150A20	Aluminium tunnel Ø 150 x 2000 mm	A	412,40	499,00	

	BP150A30	Aluminium tunnel Ø 150 x 3000 mm	A	660,33	799,00
	BP185A10	Aluminium tunnel Ø 185 x 1000 mm	A	338,02	409,00
	BP185A15	Aluminium tunnel Ø 185 x 1500 mm	A	412,40	499,00
	BP185A30	Aluminium tunnel Ø 185 x 3000 mm	A	718,18	869,00
	BP250A10	Aluminium tunnel Ø 250 x 1000 mm	A	519,83	629,00
	BP250A15	Aluminium tunnel Ø 250 x 1500 mm	A	701,65	849,00
	BP250A30	Aluminium tunnel Ø 250 x 3000 mm	A	1.486,78	1799,00
	BP300A10	Aluminium tunnel Ø 300 x 1000 mm	A	933,06	1129,00
	BP300A15	Aluminium tunnel Ø 300 x 1500 mm	A	1.776,03	2149,00
	BP300A30	Aluminium tunnel Ø 300 x 3000 mm	A	3.511,57	4249,00

HEKSCHROEVEN (voor spiegel-montage)

219	STERN110P	Polyester hekschroeftunnel diameter 110 mm	A	247,11	299,00
	STERN125P	Polyester hekschroeftunnel diameter 125 mm	A	288,43	349,00
	STERN150P	Polyester hekschroeftunnel diameter 150 mm	A	329,75	399,00
	STERN185P	Polyester hekschroeftunnel diameter 185 mm	A	420,66	509,00
	STERN250P	Polyester hekschroeftunnel diameter 250 mm	A	627,27	759,00
	STERN300P	Polyester hekschroeftunnel diameter 300 mm	A	784,30	949,00
	STERN400P	Polyester hekschroeftunnel diameter 400 mm	A	1.197,52	1449,00
	STERN250R	GRP spiegel-tunnel voor Rimdrive diameter 250 mm	A	354,55	429,00
	SDKIT125	Uitbreidingsset voor hekschroef kit 125 mm voor lage diepgang	A	170,25	206,00
	SDKIT150	Uitbreidingsset voor hekschroef kit 150 mm voor lage diepgang	A	280,17	339,00
	SDKIT185	Uitbreidingsset voor hekschroef kit 185 mm voor lage diepgang	A	387,60	469,00
	SDKIT250	Uitbreidingsset voor hekschroef kit 250 mm voor lage diepgang	A	561,16	679,00
	SDKIT300	Uitbreidingsset voor hekschroef kit 300 mm voor lage diepgang	A	883,47	1069,00

PANELEN VOOR BOEG- EN HEKSCHROEVEN

220	BPSR	Boegschroefpaneel, rond met drukknoppen, inbouw Ø 52 mm, 12/24 V	A	154,55	187,00
	BPJR	Boegschroefpaneel rond met joy-stick, inbouw Ø 52 mm, 12/24 V	A	222,31	269,00
	BPAS	Boegschroefpaneel Aluminium met drukknoppen 95x95 mm, inbouw Ø 52 mm, 12/24 V	A	164,46	199,00
	BPJAJ	Boegschroefpaneel Aluminium met joy-stick, 95x95 mm, inbouw Ø 52 mm, 12/24 V	A	247,11	299,00
	BPJSTA	Zwenkschakelaar (Joy-stick) voor boegschroef	A	119,01	144,00
	EZDOCK2	Easy Docking Systeem voor boeg/hekschroef, 12/24V	A	338,02	409,00
	BPSE2	Boegschroefpaneel met drukknoppen (met ingebouwde tijdsvertraging)	A	149,59	181,00
	BPJE2	Boegschroefpaneel met zwenkschakelaar (met ingebouwde tijdsvertraging)	A	230,58	279,00
	BPJDE2	Boegschroefpaneel met 2 zwenkschakelaars (met ingebouwde tijdsvertraging)	A	387,60	469,00
	BPA	Verloopplaat oude BPS/BPJ panelen naar BPSE/BPJE	A	31,36	37,95
221	BPPJA	BOW PRO Proportional Joystick met lock-&-hold functie en aluminium afwerking	A	544,63	659,00
	BPPPA	BOW PRO Proportional Paddle met aluminium afwerking	A	379,34	459,00
	DBPPJA	Dubbel thruster paneel (proportioneel, CAN)	A	883,47	1069,00
	BPSRC	Thruster paneel	A	271,90	329,00
	BPJRC	Thruster paneel	A	263,64	319,00

AFSTANDSBEDIENINGEN VOOR HYDRAULISCHE BOEG EN HEKSCHROEVEN

222	BPJSTH5	Zwenkschakelaar (joy-stick) 5 standen voor boegschroef	A	561,16	679,00
	BPJ5	Paneel met 5 standen zwenkschakelaar (joy-stick) voor hydr. boegschroef	A	693,39	839,00
	BPJ5D	Paneel met twee 5 standen zwenkschakelaars (joy-stick) voor hydr. Boeg-en hekschroef	A	1.255,37	1519,00
	HT1034	Joystick met draaislot	A	858,68	1039,00
	BPJE2	Boegschroefpaneel met zwenkschakelaar (met ingebouwde tijdsvertraging)	A	230,58	279,00
	BPJDE2	Boegschroefpaneel met 2 zwenkschakelaars (met ingebouwde tijdsvertraging)	A	387,60	469,00
	BPJSTA	Zwenkschakelaar (Joy-stick) voor boegschroef	A	119,01	144,00

AFSTANDBEDIENINGEN

















223	RECON	Handafstandsbediening te gebruiken bij, o.a.: boeg-hekschroeven, ankerlieren, enz.	A	178,51	216,00
	CANVWRC	CAN Compatible draadloos afstandbedieningssysteem, 12/24 V, incl. basis unit, één afstandbediening en 2 aansluitkabels	A	354,55	429,00
	WRC	Basisunit voor draadloze afstandsbediening (bestellen samen met R&C)	A	304,96	369,00
	WRCKF	Afstandsbediening 12/24V draadloos	A	38,80	46,95

V-DOCKER

224	VDSETT	V-DOCKER voor reguliere thrusters	A	4.668,60	5649,00
	VDSETR	V-DOCKER voor retractable thrusters	A	4.048,76	4899,00
	VDJOY	Joystick voor V-DOCKER systeem	A	1.776,03	2149,00
	VDIO	Converter voor standaard boegschroef naar CAN signaal	A	354,55	429,00

VDACT	Aandrijfunit voor V-DOCKER systeem	A	1.643,80	1989,00	
BPCANIN	CAN interface voor boegschroeven	ST	214,05	259,00	

TOEBEHOREN VOOR BOEG- EN HEKSCHROEVEN

226	BPSM	Boegschroefpaneel met tuimelschakelaar, voor zijmontage (waterdicht volgens IP65)	A	175,21	212,00	
	BPTD12	Tijdvertragingsschakelaar 12 Volt voor boegschroefpanelen BPSM en BPJSTA	A	152,07	184,00	
	BPTD24	Tijdvertragingsschakelaar 24 Volt voor boegschroefpanelen BPSM en BPJSTA	A	152,07	184,00	
	BP29	Verbindingskabel 6 mtr. bedieningspaneel/boegschroef	A	54,55	66,00	
	BP2910	Verbindingskabel 10 mtr. bedieningspaneel/boegschroef	A	71,90	87,00	
	BP2916	Verbindingskabel 16 mtr. bedieningspaneel/boegschroef	A	90,91	110,00	
	BP2918	Verbindingskabel 18 mtr. bedieningspaneel/boegschroef	A	106,61	129,00	
	BP2920	Verbindingskabel 20 mtr. bedieningspaneel/boegschroef	A	109,92	133,00	
	BPCAB1HF	CAN kabel (haloogenvrij) 1 meter	A	32,19	38,95	
	BPCAB5HF	CAN kabel (haloogenvrij) 5 meter	A	45,45	55,00	
	BPCAB10HF	CAN kabel (haloogenvrij) 10 meter	A	61,98	75,00	
	BPCAB15HF	CAN kabel (haloogenvrij) 15 meter	A	75,21	91,00	
	BPCAB20HF	CAN kabel (haloogenvrij) 20 meter	A	91,74	111,00	
	BPCAB25HF	CAN kabel (haloogenvrij) 25 meter	A	104,96	127,00	
227	BPROASET	Aansluitset for BOW PRO (BOWA)	A	190,08	230,00	
	BPROBSET	Aansluitset for BOW PRO Boosted (BOWB)	A	139,67	169,00	
	BPMAIN12	Hoofdschakelaar/noodstop voor boeg/hekschroeven, 12 Volt	A	701,65	849,00	
	BPMAIN24	Hoofdschakelaar/noodstop voor boeg/hekschroeven, 24 Volt	A	701,65	849,00	
	BPMEC	Tussenkabel 6 meter voor BPMAIN	A	64,46	78,00	
	BPMRC	Afstandsbediening voor BPMAIN	A	338,02	409,00	
228	BATSW075	Accu-hoofdschakelaar, 75 A (350 A / 5 sec.)	C	38,80	46,95	
	BATSW100	Accu-hoofdschakelaar, 100 A (500 A / 5 sec.)	C	43,80	53,00	
	BATSW150B	Accu-hoofdschakelaar, 150 A (1000 A / 5 sec.)	C	60,33	73,00	
	BATSW150R	Accu-hoofdschakelaar, 150 A (1000 A / 5 sec.)	C	60,33	73,00	
	BATSW250	Accu-hoofdschakelaar, 250 A (2500 A / 5 sec.)	C	74,38	90,00	
	BATSW250T	Accu hoofdschakelaar dubbele 250 Amp. (2500 A / 5 sec.)	C	105,79	128,00	
	BATSW600	Accu-hoofdschakelaar, 450 A (4500 A / 5 sec.)	C	114,88	139,00	
	BPSPE	Serie parallel schakelaar 12->24 Volt voor boeg/hekschroeven	A	883,47	1069,00	
	ZE040	Stripzekering C20 -40 Ampère	A	14,83	17,95	
	ZE050	Stripzekering C20 -50 Ampère	A	14,83	17,95	
	ZE063	Stripzekering C20 -63 Ampère	A	14,83	17,95	
	ZE080	Stripzekering C20 -80 Ampère	A	14,83	17,95	
	ZE100	Stripzekering C20 -100 Ampère	A	14,83	17,95	
	ZE125	Stripzekering C20 -125 Ampère	A	14,83	17,95	
	ZE160	Stripzekering C20 -160 Ampère	A	14,83	17,95	
	ZE200	Stripzekering C20 -200 Ampère	A	14,83	17,95	
	ZE250	Stripzekering C20 -250 Ampère	A	14,83	17,95	
	ZE300	Stripzekering C20 -300 Ampère	A	15,66	18,95	
	ZE355	Stripzekering C20 -355 Ampère	A	17,31	20,95	
	ZE425	Stripzekering C20- 425 Ampère	A	18,14	21,95	
	ZE500	Stripzekering C20- 500 Ampère	A	18,14	21,95	
	ZE700	Stripzekering C20- 700 Ampère	A	42,98	52,00	
	ZEHC100	Zekeringhouder C100, incl. beschermkap	A	52,07	63,00	
	BPSPE	Serie parallel schakelaar 12->24 Volt voor boeg/hekschroeven	A	883,47	1069,00	
	BP3008	Serie parallel schakelaar 12->24 Volt voor boeg/hekschroeven	A	1.007,44	1219,00	



















POWER HYDRAULICA
HYDRAULISCHE POMPEN

232	HT1015SD2	Variabel instelbare plunjerpomp, 45cc, linksdraaiend, SAE-B flens, aansluiting achterzijde	A	2.891,74	3499,00	
	HT1015E62	Variabel instelbare plunjerpomp, 62 cc, linksdraaiend, SAE-B flens, aansluiting achterzijde	A	4.709,92	5699,00	
	HT1016SD1	Variabel instelbare plunjerpomp, 30cc, linksdraaiend, SAE-B flens, aansluiting zijkant	A	2.767,77	3349,00	
	HT1016SD2	Variabel instelbare plunjerpomp, 45cc, linksdraaiend, SAE-B flens, aansluiting zijkant	A	2.891,74	3499,00	
	HT1017E62	Variabel instelbare plunjerpomp, 62 cc, rechtsdraaiend, SAE-B flens, aansluiting zijkant en achterzijde	A	4.668,60	5649,00	
	HT1017DS1	Variabel instelbare plunjerpomp, 30cc, rechtsdraaiend, SAE-B flens, aansluiting zijkant	A	2.767,77	3349,00	
	HT1017SD2	Variabel instelbare plunjerpomp, 45cc, rechtsdraaiend, SAE-B flens, aansluiting zijkant	A	2.891,74	3499,00	
	HT1022SD	Variabel instelbare plunjerpomp, 75cc, linksdraaiend, SAE-C flens, aansluiting zijkant	A	4.544,63	5499,00	
	HT1023SD	Variabel instelbare plunjerpomp, 75cc, rechtsdraaiend, SAE-C flens, aansluiting zijkant	A	4.544,63	5499,00	
	HT1016SD3	Variabel instelbare plunjerpomp, 100cc, linksdraaiend, SAE-C flens, aansluiting zijkant	A	5.866,94	7099,00	
	HT1016SD4	Variabel instelbare plunjerpomp, 130cc, linksdraaiend, SAE-C flens, aansluiting zijkant	A	5.866,94	7099,00	
	HT1027	Variabel instelbare plunjerpomp, 45cc, rechtsdraaiend, SAE-B flens, voor John Deere motoren	A	2.891,74	3499,00	

		HYDRAULIEKTANKS			
234	HT1028B	Hydraulische tank voor stuurbekrachting	A	2.685,12	3249,00
	HPTANK	Basistank hydraulisch systeem, 35 liter	A	1.511,57	1829,00
	HT1010	Basistank hydraulisch systeem, 70 liter (incl. één stuurventiel voor boeg/hekschroef)	A	2.561,16	3099,00
	HT1010BS	Basistank hydraulisch systeem, 130 liter (exclusief stuur- en regeleenheden)	A	5.247,11	6349,00
	HT1026	Uitbreidings-basisblok voor 5 of meer stuur - en regeleenheden	A	1.255,37	1519,00
	VHT1	VETUS Hydraulic Oil HT, 1 liter verpakking	Q	12,36	14,95
	VHT4	VETUS Hydraulic Oil HT, 4 liter verpakking	Q	44,63	54,00
	VHT20	VETUS Hydraulic Oil HT, 20 liter verpakking	Q	126,45	153,00
		HYDRAULISCHE BOEG- EN HEKSCHROEVEN			
	BOW55HMD	Boegschroef Hydraulisch 55 kgf, 3,5 kW, tunneldiam. 150 mm	A	1.643,80	1989,00
	BOW95HMD	Boegschroef Hydraulisch 95 kgf, 6,0 kW, tunneldiam. 185 mm	A	2.023,97	2449,00
	BOW160HMD	Boegschroef Hydraulisch 160 kgf, 12,3 kW, tunneldiam. 250 mm	A	2.726,45	3299,00
	BOW230HMD	Boegschroef Hydraulisch 230 kgf, 16,4 kW, tunneldiam. 300 mm	A	3.759,50	4549,00
	BOW310HMD	Boegschroef Hydraulisch 310 kgf, 26,8 kW, tunneldiam. 300 mm.	A	4.048,76	4899,00
	BOWH410	Boegschroef Hydraulisch 410 kgf, 22 kW, buisdiam. 400 mm.	A	8.470,25	10249,00
	BOWH550	Boegschroef Hydraulisch 550 kgf, 33 kW, buisdiam. 400 mm.	A	8.470,25	10249,00
	HT1026	Uitbreidings-basisblok voor 5 of meer stuur - en regeleenheden	A	1.255,37	1519,00
	HT3057	Aansluitset voor hydraulische boegschroef 55/95 kgf	A	90,91	110,00
	HT3056	Aansluitset voor hydraulische boegschroef 160kgf	A	95,04	115,00
	HT3061	Aansluitset voor hydraulische boegschroef 230 kgf	A	152,89	185,00
	HT3058	Aansluitset voor hydraulische boegschroef 310kgf	A	142,15	172,00
	HT1026	Uitbreidings-basisblok voor 5 of meer stuur - en regeleenheden	A	1.255,37	1519,00
		HYDRAULIEK OLIE			
	VHT1	VETUS hydraulische olie HT, 1 liter verpakking	Q	12,36	14,95
	VHT4	VETUS hydraulische olie HT, 4 liter verpakking	Q	44,63	54,00
	VHT20	VETUS hydraulische olie HT, 20 liter verpakking	Q	126,45	153,00
		HYDRAULISCHE STUUR-EN REGELEENHEDEN			
236	HT1011	Eén traps "load sensing" stuur-en regeleenheid voor boeg- en hekschroeven	A	685,12	829,00
	HT1012	Twee traps "load sensing"stuur-en regeleenheid voor boeg- en hekschroeven	A	1.255,37	1519,00
	HT1013	Stuur-eenheid voor boeg-en hekschroeven	A	288,43	349,00
	HT1014	Eénrichting ventiel (24 V) voor mastaansturing (12 V beschikbaar op aanvraag)	A	1.321,49	1599,00
	HT1024	Solenoideaansturing voor het gebruik van stabilisatoren	A	1.123,14	1359,00
	HT102311	Stuur en regeleenheid tbv ankerlier flow en druk instelbaar.	A	718,18	869,00
	HT102312	Stuur en regeleenheid tbv ankerlier flow instelbaar	A		461,98
		AFSTANDBEDIENINGEN VOOR HYDRAULISCHE BOEG EN HEKSCHROEVEN			
237	BPJSTA	Zwenkschakelaar (Joy-stick) voor boegschroef	A	119,01	144,00
	BPJSTH5	Zwenkschakelaar (joy-stick) 5 standen voor boegschroef	A	561,16	679,00
	BPJ5	Paneel met 5 standen zwenkschakelaar (joy-stick) voor hydr. boegschroef	A	693,39	839,00
	BPJ5D	Paneel met twee 5 standen zwenkschakelaars (joy-stick) voor hydr. Boeg-en hekschroef	A	1.255,37	1519,00
	BPJE2	Boegschroefpaneel met zwenkschakelaar (met ingebouwde tijdsvertraging)	A	230,58	279,00
	BPJDE2	Boegschroefpaneel met 2 zwenkschakelaars (met ingebouwde tijdsvertraging)	A	387,60	469,00
	HT5034	Electronische aansluitingenkast	A	461,98	559,00
238	HT1032	Proportionele klep SD, 24 V	A	2.065,29	2499,00
	HT1032EU	Proportionele klep SD, PVG32, 0-10 V	A		Prijs op aanvraag
	HT1035	Dubbele proportionele klep SD, 24 V	A	3.718,18	4499,00
	HT1035EU	Dubbele proportionele klep SD, PVG32, 0-10 V	A		Prijs op aanvraag
	HT1034	Joystick met draaislot	A	858,68	1039,00
		HYDRAULISCHE BOEG- EN HEKSCHROEVEN			
	BOW55HMD	Boegschroef Hydraulisch 55 kgf, 3,5 kW, tunneldiam. 150 mm	A	1.643,80	1989,00
	BOW95HMD	Boegschroef Hydraulisch 95 kgf, 6,0 kW, tunneldiam. 185 mm	A	2.023,97	2449,00
	BOW160HMD	Boegschroef Hydraulisch 160 kgf, 12,3 kW, tunneldiam. 250 mm	A	2.726,45	3299,00
	BOW230HMD	Boegschroef Hydraulisch 230 kgf, 16,4 kW, tunneldiam. 300 mm	A	3.759,50	4549,00
	BOW310HMD	Boegschroef Hydraulisch 310 kgf, 26,8 kW, tunneldiam. 300 mm.	A	4.048,76	4899,00
	BP1053	Bronzen propeller voor BOW22024/BOW230HM	A	709,92	859,00
	BP1182	Bronzen propeller voor BOW310HM	A	709,92	859,00

240	BOWH410	Boegschroef Hydraulisch 410 kgf, 22 kW, buisdiam. 400 mm.	A	8.470,25	10249,00	
	BOWH550	Boegschroef Hydraulisch 550 kgf, 33 kW, buisdiam. 400 mm.	A	8.470,25	10249,00	
	BP1259	Bronzen propeller voor BOW410HM	A	1.015,70	1229,00	
	BP1260	Bronzen propeller voor BOW550HM	A	1.015,70	1229,00	

STABILISATOREN





	STAFIN03B	Set (2 stuks) stabilisatorvinnen - 0,3 m2 AISI316	A	9.792,56	11849,00	
	STAFIN04B	Set (2 stuks) stabilisatorvinnen - 0,3 m2 AISI316	A	11.817,36	14299,00	
	STAFIN05B	Set (2 stuks) stabilisatorvinnen - 0,5 m2 AISI316	A	12.602,48	15249,00	
	STAFIN06B	Set (2 stuks) stabilisatorvinnen - 0,6 m2 AISI316	A	13.263,64	16049,00	
	STAFIN07B	Set (2 stuks) stabilisatorvinnen - 0,7 m2 AISI316	A	13.511,57	16349,00	
	STA24VA	Elektronische stabilisatoren 24 V incl. paneel en computer VII	A	13.800,83	16699,00	
	HT1028S	Tank voor stabilisatoren (compleet)	A	2.685,12	3249,00	
	STATHS	Set van twee huiddoorvoeren voor stabilisatoren, stalen romp	A		2.519,83	
	STATHA	Set van twee huiddoorvoeren voor stabilisatoren, aluminium romp	A	2.437,19	2949,00	
	STATHG	Set van twee huiddoorvoeren voor stabilisatoren, glasvezel romp	A	2.023,97	2449,00	
242	HT1018	Hydraulische stuurbechrachting 95 cm ³ /omwenteling, voor cilinders tot en met de MT230	A	1.486,78	1799,00	
	HT1019	Aansturing voor stuurbechrachting en autopilot	A	1.982,64	2399,00	
	HT1020	Hydraulische stuurbechrachting 95 cm ³ /omwenteling, voor cilinders tot en met de MT230	A	1.486,78	1799,00	
	HT1021	Dubbel terugslagventiel voor hydraulische stuurbechrachting	A	193,39	234,00	
	HT1025	Stuurbechrachting (145 cm ³) voor cilinders tot en met de MT345	A	1.569,42	1899,00	
	HT1038	Stuurbechrachting (185 cm ³) voor cilinders tot en met de MT0455B	A	1.858,68	2249,00	
243	HT1029	Tandwielpompe 11, 33 met lager	A	709,92	859,00	
	HT1029CCW	Tandwielpompe 11, 33 met lager (linksdraaiend)	A		Prijs op aanvraag	
	HT3011MP	Oliekoeler (2" BSP en 3/4" BSP)	A	627,27	759,00	
	HPCOOLER	Oliekoeler 10kW 105VG 46 90 liter/min	A	718,18	869,00	
	HT1028	Hydraulisch tank voor stuurbechrachting, compleet	A	2.891,74	3499,00	
	HT1029	Tandwielpompe 11, 33 met lager	A	709,92	859,00	
	HT301132	Hydraulische olie koeler voor slang Ø 32 mm. inwendig	A	544,63	659,00	
245	PPM435	Diesel powerpack geschikt voor 310 kgf	K	11.114,88	13449,00	
	PPM445	Diesel powerpack geschikt voor 410 kgf	K	12.147,93	14699,00	
	PPH465	Diesel powerpack geschikt voor 550 kgf	K	13.222,31	15999,00	
246	EHPA12R2	Elektro-Hydr. Pomp, 12 V, type 350R (A), incl. koppelingen	A	742,98	899,00	
	EHPA24R2	Elektro-Hydr. Pomp, 24 V, type 350R (A), incl. koppelingen	A	858,68	1039,00	
	EHPB12R2	Elektro-Hydr. Pomp, 12 V, type 700R (B), incl. koppelingen	A	742,98	899,00	
	EHPB24R2	Elektro-Hydr. Pomp, 12 V, type 700R (B), incl. koppelingen	A	858,68	1039,00	
	EHPC12R2	Elektro-Hydr. Pomp, 12 V, type 950R (C), incl. koppelingen	A	751,24	909,00	
	EHPC24R2	Elektro-Hydr. Pomp, 24 V, type 950R (C), incl. koppelingen	A	858,68	1039,00	
	RECON	Handafstandsbediening te gebruiken bij, o.a.: boeg-hekschroeven, ankerlieren, enz.	A	178,51	216,00	
247	HL12500A	Elektro-hydraulisch hefsysteem L=500 mm. 12 Volt, 125 kgf.	A	1.511,57	1829,00	
	HL12500B	Elektro-hydraulisch hefsysteem L=500 mm. 12 Volt, 320 kgf.	A	1.610,74	1949,00	
	HL500	Uitbreidingsset 2e cilinder voor hydraulisch hefsysteem L= 500 mm, 125 kgf.	A	685,12	829,00	
	HL500B	Uitbreidingsset 2e cilinder voor hydraulisch hefsysteem L= 500 mm, 320 kgf.	A	784,30	949,00	
	SLP7/1620	Slangpilaar 7/16"-20 UNF- 8 mm	ST	7,40	8,95	
	EHPESET	Set eindschakelaars voor EHP (2 stuks)	A	137,19	166,00	

STROOM AAN BOORD

GENERATOREN EN POWERPACKS

Prijs op aanvraag

ACCULADERS

254	BC12151	4-fase acculader - 12 V / 15 A	B	387,60	469,00	
	BC12252	4-fase acculader - 12 V / 25 A	B	470,25	569,00	
	BC12352	4-fase acculader - 12 V / 35 A	B	577,69	699,00	
	BC24122	4-fase acculader - 24 V / 12,5 A	B	585,95	709,00	
	BC12503	4-fase acculader - 12 V / 50 A	B	668,60	809,00	
	BC24253	4-fase acculader - 24 V / 25 A	B	668,60	809,00	
	BC12803	4-fase acculader - 12 V / 80 A	B	916,53	1109,00	
	BC24403	4-fase acculader - 24 V / 40 A	B	916,53	1109,00	

	BCRC	Extern bedienpaneel acculader	B	162,81	197,00
	BCTS	Acculader-temperatuursensor	B	28,06	33,95

ACCUSCHEIDER

255	BC120517	Acculader 12V 5A met 7 fase laadprogr mm a	A	75,21	91,00
	BS1502C	Accuscheider, 12/24 Volt, met 1 x 150A ingang en 2 uitgangen	A	195,87	237,00
	BS1503C	Accuscheider, 12/24 Volt, met 1 x 150A ingang en 3 uitgangen	A	222,31	269,00
	BS15032C	Accuscheider, 12/24 Volt, met 2 x 150A ingangen en 3 uitgangen	A	379,34	459,00

ACCUBAKKEN

	BATBOXS	Accubak voor VESMF60, VEAGM60	C	18,14	21,95
	BATBOXM	Accubak voor VESMF70, VEAGM70	C	27,23	32,95
	BATBOXL	Accubak voor VESMF85/105, VEAGM 90/100	C	28,88	34,95

ACCU'S

256	VESMF60	VETUS Maintenance free accu, 60 Ah	K	119,83	145,00
	VESMF70	VETUS Maintenance free accu, 70 Ah	K	136,36	165,00
	VESMF85	VETUS Maintenance free accu, 85 Ah	K	164,46	199,00
	VESMF105	VETUS Maintenance free accu, 105 Ah	K	201,65	244,00
	VESMF125	VETUS Maintenance free accu, 125 Ah	K	263,64	319,00
	VESMF145	VETUS Maintenance free accu, 145 Ah	K	313,22	379,00
	VESMF165	VETUS Maintenance free accu, 165 Ah	K	362,81	439,00
	VESMF200	VETUS Maintenance free accu, 200 Ah	K	420,66	509,00
	VESMF220	VETUS Maintenance free accu, 220 Ah	K	445,45	539,00
	VEAGM60	VETUS AGM power accu, 60 Ah	K	200,83	243,00
	VEAGM70	VETUS AGM power accu, 70 Ah	K	230,58	279,00
	VEAGM90	VETUS AGM power accu, 90 Ah	K	271,90	329,00
	VEAGM100	VETUS AGM power accu, 100 Ah	K	313,22	379,00
	VEAGM140	VETUS AGM power accu, 140 Ah	K	387,60	469,00
	VEAGM170	VETUS AGM power accu, 170 Ah	K	461,98	559,00
	VEAGM185	VETUS AGM power accu, 185 Ah	K	511,57	619,00
	VEAGM220	VETUS AGM power accu, 220 Ah	K	561,16	679,00

257	VEDC110TC	VETUS Deep Cycle accu, 110 Ah met dubbele connector	K	222,31	269,00
Nieuw!	VELFP105A	Accuset LiFePO4 48V-105Ah type Nomada 5,1kWh compleet 4S-1P systeem met 48V, 25 Amp lader	EP	8.594,21	10399,00
Nieuw!	VELFP210A	Accuset LiFePO4 48V-105Ah type Nomada 10,2kWh compleet 4S-2P systeem met 48V, 25 Amp lader	EP	14.296,69	17299,00
Nieuw!	VELFP420A	Accuset LiFePO4 48V-105Ah type Nomia 20,4kWh compleet 4S-2P systeem met 48V, 25 Amp lader	EP	23.842,15	28849,00

ACCESSOIRES ACCU'S

258	ACCUSCH	Accu-keuzeschakelaar, 175 A (continue)	C	101,65	123,00
	BATSW075	Accu-hoofdschakelaar, 75 A (350 A / 5 sec.)	C	38,80	46,95
	BATSW100	Accu-hoofdschakelaar, 100 A (500 A / 5 sec.)	C	43,80	53,00
	BATSW150B	Accu-hoofdschakelaar, 150 A (1000 A / 5 sec.)	C	60,33	73,00
	BATSW150R	Accu-hoofdschakelaar, 150 A (1000 A / 5 sec.)	C	60,33	73,00
	BATSW250	Accu-hoofdschakelaar, 250 A (2500 A / 5 sec.)	C	74,38	90,00
	BATSW250T	Accu hoofdschakelaar dubbele 250 Amp. (2500 A / 5 sec.)	C	105,79	128,00
	BATSW600	Accu-hoofdschakelaar, 450 A (4500 A / 5 sec.)	C	114,88	139,00





ZEKERINGEN EN ZEKERINGHOUDERS

259	ZEHC100	Zekeringhouder C100, incl. beschermkap	A	52,07	63,00
	ZEHCAP	Afdekking voor zekeringhouder ZEHC100	A	3,47	4,20
	ZE040	Stripzekering C20 -40 Ampère	A	14,83	17,95
	ZE050	Stripzekering C20 -50 Ampère	A	14,83	17,95
	ZE063	Stripzekering C20 -63 Ampère	A	14,83	17,95
	ZE080	Stripzekering C20 -80 Ampère	A	14,83	17,95
	ZE100	Stripzekering C20 -100 Ampère	A	14,83	17,95
	ZE125	Stripzekering C20 -125 Ampère	A	14,83	17,95
	ZE160	Stripzekering C20 -160 Ampère	A	14,83	17,95
	ZE200	Stripzekering C20 -200 Ampère	A	14,83	17,95
	ZE250	Stripzekering C20 -250 Ampère	A	14,83	17,95
	ZE300	Stripzekering C20 -300 Ampère	A	15,66	18,95
	ZE355	Stripzekering C20 -355 Ampère	A	17,31	20,95
	ZE425	Stripzekering C20- 425 Ampère	A	18,14	21,95
	ZE500	Stripzekering C20- 500 Ampère	A	18,14	21,95
Nieuw!	ZE700	Stripzekering C20- 700 Ampère	A	42,98	52,00







RELAIS

AFST1512D	Relais dubbel, 12 Volt, 1500 Watt, M8 terminals	A	214,05	259,00	
SOL1512D	Relais dubbel, 12 Volt, 1500 Watt, M6 terminals	A	154,55	187,00	
SOL324D	Relais dubbel, 24 Volt, 3000 Watt, M6 terminals	A	151,24	183,00	
AFST324D	Relais dubbel, 24 Volt, 3000 Watt, M8 terminals	A	214,05	259,00	
AFST624D	Relais dubbel, 24 Volt, 6000 Watt, M10 terminals	A	495,04	599,00	
AFST1512S	Relais enkel, 12 Volt, 1500 Watt, M8 terminals	A	94,21	114,00	
SOL1512S	Relais enkel, 12 Volt, 1500 Watt, M6 terminals	A	70,25	85,00	
SOL324S	Relais enkel, 24 Volt, 3000 Watt, M6 terminals	A	70,25	85,00	
AFST324S	Relais enkel, 24 Volt, 3000 Watt, M8 terminals	A	92,56	112,00	
AFST624S	Relais enkel, 24 Volt, 6000 Watt, M10 terminals	A	238,84	289,00	

ACCUKABEL

260	BATC06M	Accukabel 6 mm ² , PVC, zwart (prijs per meter)	Q	3,55	4,30	
	BATC10M	Accukabel 10 mm ² , PVC, zwart (prijs per meter)	Q	6,98	8,45	
	BATC35	Accukabel 35 mm ² , PVC, zwart (prijs per meter)	Q	11,53	13,95	
	BATC50	Accukabel 50 mm ² , PVC, zwart (prijs per meter)	Q	17,31	20,95	
	BATC70	Accukabel 70 mm ² , PVC, zwart (prijs per meter)	Q	23,10	27,95	
	BATC95	Accukabel 95 mm ² , PVC, zwart (prijs per meter)	Q	31,36	37,95	
	BATC120	Accukabel 120 mm ² , PVC, zwart (prijs per meter)	Q	38,80	46,95	
	BATC06RM	Accukabel 6 mm ² , PVC, rood (prijs per meter)	Q	3,55	4,30	
	BATC10RM	Accukabel 10 mm ² , PVC, rood (prijs per meter)	Q	6,98	8,45	
	BATC35R	Accukabel 35 mm ² , PVC, rood (prijs per meter)	Q	11,53	13,95	
	BATC50R	Accukabel 50 mm ² , PVC, rood (prijs per meter)	Q	17,31	20,95	
	BATC70R	Accukabel 70 mm ² , PVC, rood (prijs per meter)	Q	23,10	27,95	
	BATC95R	Accukabel 95 mm ² , PVC, rood (prijs per meter)	Q	31,36	37,95	
	BATC120R	Accukabel 120 mm ² , PVC, rood (prijs per meter)	Q	38,80	46,95	

KABELSCHOENEN





	BATCC0606	Kabelschoen voor 6 mm ² accukabel met gat M6 (per 10 stuks)	Q	16,49	19,95	
	BATCC0608	Kabelschoen voor 6 mm ² accukabel met gat M8 (per 10 stuks)	Q	16,49	19,95	
	BATCC0610	Kabelschoen voor 6 mm ² accukabel met gat M10 (per 10 stuks)	Q	15,66	18,95	
	BATCC1006	Kabelschoen voor 10 mm ² accukabel met gat M6 (per 10 stuks)	Q	20,62	24,95	
	BATCC1008	Kabelschoen voor 10 mm ² accukabel met gat M8 (per 10 stuks)	Q	19,79	23,95	
	BATCC1010	Kabelschoen voor 10 mm ² accukabel met gat M10 (per 10 stuks)	Q	19,79	23,95	
	BATCC3506	Kabelschoen voor 35 mm ² accukabel met gat M6 (prijs per 2 stuks)	Q	5,74	6,95	
	BATCC3508	Kabelschoen voor 35 mm ² accukabel met gat M8 (prijs per 2 stuks)	Q	5,74	6,95	
	BATCC3510	Kabelschoen voor 35 mm ² accukabel met gat M10 (prijs per 2 stuks)	Q	5,74	6,95	
	BATCC5006	Kabelschoen voor 50 mm ² accukabel met gat M6 (prijs per 2 stuks)	Q	8,22	9,95	
	BATCC5008	Kabelschoen voor 50 mm ² accukabel met gat M8 (prijs per 2 stuks)	Q	8,22	9,95	
	BATCC5010	Kabelschoen voor 50 mm ² accukabel met gat M10 (prijs per 2 stuks)	Q	8,22	9,95	
	BATCC7006	Kabelschoen voor 70 mm ² accukabel met gat M6 (prijs per 2 stuks)	Q	9,88	11,95	
	BATCC7008	Kabelschoen voor 70 mm ² accukabel met gat M8 (prijs per 2 stuks)	Q	9,88	11,95	
	BATCC7010	Kabelschoen voor 70 mm ² accukabel met gat M10 (prijs per 2 stuks)	Q	9,88	11,95	
	BATCC9508	Kabelschoen voor 95 mm ² accukabel met gat M8 (prijs per 2 stuks)	Q	15,66	18,95	
	BATCC9510	Kabelschoen voor 95 mm ² accukabel met gat M10 (prijs per 2 stuks)	Q	15,66	18,95	
	BATCC9512	Kabelschoen voor 95 mm ² accukabel met gat M12 (prijs per 2 stuks)	Q	15,66	18,95	
	BATCC1210	Kabelschoen voor 120 mm ² accukabel met gat M10 (prijs per 2 stuks)	Q	17,31	20,95	
	BATCC1212	Kabelschoen voor 120 mm ² accukabel met gat M12 (prijs per 2 stuks)	Q	17,31	20,95	
	BATCC1510	Kabelschoen voor 150 mm ² accukabel met gat M10 (prijs per 2 stuks)	Q	22,27	26,95	
	BATCC1512	Kabelschoen voor 150 mm ² accukabel met gat M12 (prijs per 2 stuks)	Q	21,45	25,95	

ACCUPOOL KLE mm EN



	BATT1635	Accupool-kle mm en 16-35 mm ² (prijs per 2 stuks)	Q	13,18	15,95	
	BATT5095	Accupool-kle mm en 50-95 mm ² (prijs per 2 stuks)	Q	17,31	20,95	
	BATT150	Accupool-kle mm en met M10 bout, tot 150 mm ² (prijs per 2 stuks)	Q	22,27	26,95	

WALSTROOM



261	EOCABC5M	Walstroomkabel 5 meter 16A IP44 H07BQ-F 3G 2,50 mm ² PUR	A	90,08	109,00	
	EOCABC15M	Walstroomkabel 15 meter 16A IP44 H07BQ-F 3G 2,50 mm ² PUR	A	149,59	181,00	
	EOCABX15M	Verlengkabel CEE naar CEE, 5 meter 20A H07RN-F 3G 2,50 mm ²	A	121,49	147,00	
	EOCABC5M	Walstroomkabel 5 meter, 16A, IP44 H07BQ-F 3G 2,50 mm ² PUR	A	90,08	109,00	
	EOADAP	CEE-Schuko EURO adapterkabel, 16A, kabellengte 0,3 meter	A	22,27	26,95	
	EOCLDSET	Steiger clip walstroom 16A kabel (set van 6 stk)	A	18,14	21,95	
	EOCLRSET	Rail clip walstroom 16A kabel (set van 6 stk)	A	17,31	20,95	
	EOSPW16S	Walstroom aansluiting 16A, IP56, RVS 316	K	95,87	116,00	

	EOSPW16W	Walstroom aansluiting 16A, IP56, wit	Q	64,46	78,00
	EOQSPW16S	Walstroom aansluiting 16A, IP56, RVS 316	A	121,49	147,00
	EOQSPW16W	Walstroom aansluiting 16A, IP56, wit	A	92,56	112,00
	EO1RCBO	Zekeringkast RCBO met enkel Schuko stopcontact	A	160,33	194,00
	EOQ1RCBO	Zekeringkast RCBO met enkel Schuko stopcontact	A	247,11	299,00
	EOQISOLA	Galvanische isolator, max. 16A	A	238,84	289,00
	EOQSPLIT	Splitter, max. 16A	A	33,02	39,95
	EOQCABX1M	Verlengkabel 1 meter 20A H07RN-F 3G 2,50 mm 2	A	38,80	46,95
	EOQCABX3M	Verlengkabel 3 meter 20A H07RN-F 3G 2,50 mm 2	A	64,46	78,00
	EOQCABX5M	Verlengkabel 5 meter 20A H07RN-F 3G 2,50 mm 2	A	92,56	112,00
	EOW1RFS	Schuko stopcontact 16A, gepolijst RVS 316	A	109,92	133,00
	EOQW1NFW	Schuko stopcontact 16A, wit	A	57,02	69,00
	EOQW1NFB	Schuko stopcontact 16A, zwart	A	57,02	69,00
	EOQW1RFS	Schuko stopcontact 16A, gepolijst RVS 316	A	114,88	139,00
	EOQW2NSG	Schuko stopcontact 16A, wandgemonteerd, grijs	A	51,24	62,00

STUURSYSTEMEN**STUURWIELEN****STUURWIELEN TYPE PRO**

	267	PRO40P	Stuurwiel type PRO (Polyurethaan), Ø 40 cm (incl. kap)	B	230,58	279,00
		PRO50P	Stuurwiel type PRO (Polyurethaan), Ø 50 cm (incl. kap)	B	263,64	319,00
		PRO60P	Stuurwiel type PRO (Polyurethaan), Ø 60 cm (incl. kap)	B	329,75	399,00
		PRO40T	Stuurwiel type PRO (Teak), Ø 40 cm (incl. kap)	B	362,81	439,00
		PRO50T	Stuurwiel type PRO (Teak), Ø 50 cm (incl. kap)	B	395,87	479,00
		PRO60T	Stuurwiel type PRO (Teak), Ø 60 cm (incl. kap)	B	428,93	519,00
		PASBUSA	Stuurwiel adapter voor Ø3/4" as, verhouding 1:12 to Ø1"	A	14,01	16,95



STUURWIELEN MET MAHONIEHOUTEN HOEPEL

	268	KW38	Stuurwiel type KW38, Ø 380 mm (incl. kap)	B	288,43	349,00
		KW45	Stuurwiel type KW45, Ø 450 mm (incl. kap)	B	313,22	379,00
		KW55	Stuurwiel type KW55, Ø 550 mm (incl. kap)	B	329,75	399,00
		KW71	Stuurwiel type KW71, Ø 710 mm (incl. kap)	A	453,72	549,00
	Nieuw!	KW71U	Stuurwiel type KW71U ongelakt, Ø 710 mm (incl. kap)	A	453,72	549,00
		KW81	Stuurwiel type KW81, Ø 810 mm (incl. kap)	A	495,04	599,00



STUURWIELEN MET MAHONIEHOUTEN HOEPEL EN SPAKEN

	269	KWL38	Stuurwiel type KWL38, Ø 380 mm (incl. kap)	B	428,93	519,00
		KWL45	Stuurwiel type KWL45, Ø 450 mm (incl. kap)	B	445,45	539,00
		KWL55	Stuurwiel type KWL55, Ø 550 mm (incl. kap)	B	453,72	549,00

STUURWIELEN TYPE KS

		KS32G	KS32, Ø 320 mm, grijs (incl. kap)	B	109,09	132,00
		KS32Z	KS32, Ø 320 mm, zwart (incl. kap)	B	109,09	132,00
		KS36G	KS36, Ø 360 mm, grijs (incl. kap)	B	112,40	136,00
		KS36Z	KS36, Ø 360 mm, zwart (incl. kap)	B	112,40	136,00
	270	KS38G	KS38, Ø 380 mm, grijs (incl. kap)	B	190,08	230,00
		KS38Z	KS38, Ø 380 mm, zwart (incl. kap)	B	190,08	230,00
		KS45G	KS45, Ø 450 mm, grijs (incl. kap)	B	222,31	269,00
		KS45Z	KS45, Ø 450 mm, zwart (incl. kap)	B	222,31	269,00
		KS55G	KS55, Ø 550 mm, grijs (incl. kap)	B	263,64	319,00
		KS55Z	KS55, Ø 550 mm, zwart (incl. kap)	B	263,64	319,00







SPORTSTUREN

		SWCRUISER	Stuurwiel Cruiser, Ø30 cm, zwart met aluminium	A	100,00	121,00
	271	SWALB30	Stuurwiel ALBUS, wit, 300 mm	A	222,31	269,00
		SWTEC35	Stuurwiel TECTONA, hout, 350 mm	A	263,64	319,00
		SWALT33	Stuurwiel ALTER, zwart, 330 mm	A	123,97	150,00
		SWRAV33	Stuurwiel RAVUS, grijs, 330 mm	A	123,97	150,00
		SWARG32	Stuurwiel ARGENTUS, chroom, 320 mm	A	137,19	166,00
		SWNOC35	Stuurwiel NOCTIS, zwart met chroom, 350 mm	A	142,15	172,00









STUURPOMPEN ZONDER TERUGSLAGKLEP

273	HTP2010	Stuurpomp type HTP20, wit, voor Ø 10 mm leiding (kunststof of koper)	A	445,45	539,00	
	HTP3010	Stuurpomp type HTP30, wit, voor Ø10 mm leiding (kunststof of koper)	A	486,78	589,00	
	HTP4210	Stuurpomp type HTP42, wit, voor Ø10 mm leiding (kunststof of koper)	A	511,57	619,00	
	HTP2010B	Stuurpomp type HTP20, zwart, voor Ø 10 mm leiding (kunststof of koper)	A	445,45	539,00	
	HTP3010B	Stuurpomp type HTP30, zwart, voor Ø10 mm leiding (kunststof of koper)	A	486,78	589,00	
	HTP4210B	Stuurpomp type HTP42, zwart, voor Ø10 mm leiding (kunststof of koper)	A	511,57	619,00	





STUURPOMPEN MET TERUGSLAGKLEP

	HTP2010R	Stuurpomp type HTP20, wit, voor Ø 10 mm leiding, met terugslagklep	A	528,10	639,00	
	HTP3010R	Stuurpomp type HTP30, wit, voor Ø 10 mm leiding, met terugslagklep	A	569,42	689,00	
	HTP4210R	Stuurpomp type HTP42, wit, voor Ø 10 mm leiding, met terugslagklep	A	594,21	719,00	
	HTP2010RB	Stuurpomp type HTP20, zwart, voor Ø 10 mm leiding, met terugslagklep	A	528,10	639,00	
	HTP3010RB	Stuurpomp type HTP30, zwart, voor Ø 10 mm leiding, met terugslagklep	A	569,42	689,00	
	HTP4210RB	Stuurpomp type HTP42, zwart, voor Ø 10 mm leiding, met terugslagklep	A	594,21	719,00	













HYDRAULISCHE CILINDERS

274	MTC5210	Cilinder type MTC52, voor Ø10 mm leiding (kunststof of koper)	A	420,66	509,00	
	MTC7210	Cilinder type MTC72, voor Ø10 mm leiding (kunststof of koper)	A	453,72	549,00	
	MTC12510	Cilinder type MTC125, voor Ø10 mm leiding (kunststof of koper)	A	652,07	789,00	
	MTC17510	Cilinder type MTC175, voor Ø10 mm leiding (kunststof of koper)	A	685,12	829,00	
276	MTC7210SL	Cilinder MTC72, voor aangehangen roerbladen	A	453,72	549,00	
	MTC30KIT	Hydraulische besturings kit incl. cilinder (MTC30), pomp (HTP2008), nylon leiding (15 meter), fittingen en olie	A	767,77	929,00	
	HTPFK	Vulset voor de HTP	A	Prijz op aanvraag		
	MTC3008	Cilinder MTC30 voor pijp Ø 8 mm	A	486,78	589,00	



STUURPOMPEN

	HTP2008T	Stuurpomp type HTP2008R met kantelbare as, incl. opgebouwde terugslagklep	OUT	181,82	220,00	
	HTP2010T	Stuurpomp type HTP2010R met kantelbare as, incl. opgebouwde terugslagklep	OUT	181,82	220,00	
	HTP3008T	Stuurpomp type HTP3008R met kantelbare as, incl. opgebouwde terugslagklep	OUT	181,82	220,00	
	HTP4210T	Stuurpomp type HTP4210R met kantelbare as, incl. opgebouwde terugslagklep	OUT	180,99	219,00	





HYDRAULISCHE BESTURINGEN VOOR BEROEPSVAARTUIGEN

278	MT0230B	Cilinder type MT0230, incl. 600 mm flexibele aansluitslangen	A	2.106,61	2549,00	
	MT0345B	Cilinder type MT0345, incl. 600 mm flexibele aansluitslangen	A	2.313,22	2799,00	
	MT0455B	Cilinder type MT0455, incl. 600 mm flexibele aansluitslangen	A	2.437,19	2949,00	
	MT0600B	Cilinder type MT0600, incl. 600 mm flexibele aansluitslangen	A	3.304,96	3999,00	
	MT0900B	Cilinder type MT0900, incl. 600 mm flexibele aansluitslangen	A	4.007,44	4849,00	
	MT1200B	Cilinder type MT1200, incl. 600 mm flexibele aansluitslangen	A	4.296,69	5199,00	
	MTP089B	Stuurpomp type MTP089, incl. koppelingen Ø 18 mm	A	1.982,64	2399,00	
	MTP151B	Stuurpomp type MTP151, incl. koppelingen Ø 18 mm	A	2.726,45	3299,00	
	MTP191B	Stuurpomp type MTP191, incl. koppelingen Ø 18 mm	A	2.933,06	3549,00	
	HS81B	Dubbele terugslagklep, G½, incl. koppelingen Ø 18 mm.	A	552,89	669,00	
	HS74B	Enkele terugslagklep, G½, met kortsluitkraan incl. koppelingen Ø 18 mm.	A	619,01	749,00	
	HS42B	Overdrukventiel, G½, incl. koppelingen Ø 18 mm.	A	445,45	539,00	

HYDRAULISCHE BESTURING VOOR BUITENBOORDMOTOREN
HYDRAULISCHE CILINDERS

279	OBC225	Cilinder voor buitenboordmotorbesturing type OB225 (max. 225 pk)	A	329,75	399,00	
	OB1000	Tie bar voor buitenboord motoren	A	395,87	479,00	

STUURPOMPEN MET TERUGSLAGKLEP

280	HTP2010R	Stuurpomp type HTP20, wit, voor Ø 10 mm leiding, met terugslagklep	A	528,10	639,00	
	HTP3010R	Stuurpomp type HTP30, wit, voor Ø 10 mm leiding, met terugslagklep	A	569,42	689,00	
	HTP4210R	Stuurpomp type HTP42, wit, voor Ø 10 mm leiding, met terugslagklep	A	594,21	719,00	
	HTP2010RB	Stuurpomp type HTP20, zwart, voor Ø 10 mm leiding, met terugslagklep	A	528,10	639,00	
	HTP3010RB	Stuurpomp type HTP30, zwart, voor Ø 10 mm leiding, met terugslagklep	A	569,42	689,00	
	HTP4210RB	Stuurpomp type HTP42, zwart, voor Ø 10 mm leiding, met terugslagklep	A	594,21	719,00	

STUURPOMP ACCESSOIRES

	HTPF	Verloopflens RVS voor HTP pomp, diepte 38 mm	A	66,94	81,00	
	HTPF2	Verloopflens RVS voor HTP pomp, diepte 78 mm	A	87,60	106,00	
	HTPF3	Rubber afsluitring voor HTPF en HTPF2 flens HS1000	A	42,98	52,00	

	281	K30/140B	Dubbele terugslagklep, voor MTC cilinders	A	296,69	359,00
		KITK30	Koppelingenkit voor dubbele terugslagklep voor K30/140B en MTC3008	A	93,39	113,00
		KITK52175	Koppelingenkit voor dubbele terugslagklep voor K30/140B en MTC5210/MTC17510	A	71,07	86,00
		BYPASS8	Kortsluitkraan voor 8 mm leiding	A	59,50	72,00
		BYPASS10	Kortsluitkraan voor 10 mm leiding	A	71,07	86,00
		BYPASS18	Kortsluitkraan, G½, incl. koppelingen Ø 18 mm	A	120,66	146,00
		HS04N	Nylon slang Ø 6 x 8 mm. (per rol van 15 m.)	A	47,93	58,00
		HHOSE6015	Nylon slang Ø 6 x 10 mm. (per rol 15 meter)	A	177,69	215,00
		HHOSE6030	Nylon slang Ø 6 x 10 mm. (per rol 30 meter)	A	362,81	439,00
		HHOSE6050	Nylon slang Ø 6 x 10 mm. (per rol 50 meter)	A	577,69	699,00
		HHOSE6100	Nylon slang Ø 6 x 10 mm. (per rol 100 meter)	A	1.081,82	1309,00
		HHOSE8015	Nylon slang Ø 8 x 12 mm. (per rol 15 meter)	A	238,84	289,00
		HHOSE8030	Nylon slang Ø 8 x 12 mm. (per rol 30 meter)	A	470,25	569,00
		HHOSE8050	Nylon slang Ø 8 x 12 mm. (per rol 50 meter)	A	767,77	929,00
	HHOSE8100	Nylon slang Ø 8 x 12 mm. (per rol 100 meter)	A	1.428,93	1729,00	

	282	HS10131	Set steunhulzen Ø 6 mm en 2 snijringen Ø 8 mm voor HS04N (per 10 stuks)	A	63,64	77,00
		HS1011S	Set steunhulzen, Ø 6 mm voor HS04N (per 20 stuks)	A	16,49	19,95
		HS145S	Set steunhulzen, Ø 6,5 mm voor Nylon slang Ø 6 x Ø 10 mm. (per 20 stuks)	A	35,50	42,95
		HS1031MS	Rechte connectorset (brons) voor nylon slang (2x)	A	21,45	25,95
		HS1037MS	90 graden hoek connectorset (brons) voor nylon slang (2x)	A	23,10	27,95
	Nieuw!	HS1039MS	Rechte connectorset (brons) voor 10 mm slang (2x)	A	22,27	26,95
		COPPER08	Koperen leiding, Ø 6 x 8 mm. (per rol van 16 meter)	A	197,52	239,00
		COPPER10	Koperen leiding, Ø 8 x 10 mm. (per rol van 20 meter)	A	296,69	359,00
		COPPER18	Koperen leiding, Ø 15 x 18 mm. (per rol van 10 meter)	A	470,25	569,00
		HTANK	Expansietankje voor hydraulische besturingen	A	87,60	106,00

ROESTVAST STALEN ROEREN (AISI 316)

283	RUDS4040	Roer, roestvast staal L= 400 mm. incl. roerarm	A	924,79	1119,00
	RUDS5040	Roer, roestvast staal L= 500 mm. incl. roerarm	A	1.073,55	1299,00

ROERARMEN



	HELM30	Roerarm voor roerkoning van Ø 30 mm	A	93,39	113,00
	HELM40	Roerarm voor roerkoning van Ø 40 mm	A	123,14	149,00
	HELM50	Roerarm voor roerkoning van Ø 50 mm	A	155,37	188,00
	HELM60	Roerarm voor roerkoning van Ø 60 mm	A	168,60	204,00
	HSET10	Bevestigingsset M10, voor roerarm/cilinder MTC30	A	12,36	14,95
	HSET12	Bevestigingsset M12, voor roerarm/cilinder MTC52-72	A	18,97	22,95
	HSET20	Bevestigingsset M20, voor roerarm/cilinder MTC125-175	A	30,54	36,95

HENNEGATKOKERS



284	HENKO30	Bronzen hennegatskoker Ø 30 mm L= 175	A	230,58	279,00
	HENKO40	Bronzen hennegatskoker Ø 40 mm L= 205	A	263,64	319,00
	HENKO30L	Bronzen hennegatskoker Ø 30 mm. verlengde uitvoering L= 275	A	379,34	459,00
	HENKO40L	Bronzen hennegatskoker Ø 40 mm. verlengde uitvoering L= 305	A	453,72	549,00

SCHEEPSBEGLAZING**PATRIJSPOORTEN****TYPE PL, CATEGORIE A1**







289	PL711	Patrijspoort, aluminium, type PL711, categorie A1, incl. muggenhor	A	395,87	479,00
	PL721	Patrijspoort, aluminium, type PL721, categorie A1, incl. muggenhor	A	437,19	529,00
	PL731	Patrijspoort, aluminium, type PL731, categorie A1, incl. muggenhor	A	486,78	589,00
	PL741	Patrijspoort, aluminium, type PL741, categorie A1, incl. muggenhor	A	569,42	689,00
	PL751	Patrijspoort, aluminium, type PL751, categorie A1, incl. muggenhor	A	511,57	619,00
	PL711A	Patrijspoort, helder geanodiseerd aluminium, type PL711, categorie A1, incl. muggenhor	A	395,87	479,00
	PL721A	Patrijspoort, helder geanodiseerd aluminium, type PL721, categorie A1, incl. muggenhor	A	437,19	529,00
	PL731A	Patrijspoort, helder geanodiseerd aluminium, type PL731, categorie A1, incl. muggenhor	A	486,78	589,00
	PL741A	Patrijspoort, helder geanodiseerd aluminium, type PL741, categorie A1, incl. muggenhor	A	569,42	689,00
	PL751A	Patrijspoort, helder geanodiseerd aluminium, type PL751, categorie A1, incl. muggenhor	A	511,57	619,00
	PL71F	Patrijspoort vast, aluminium, type PL711, categorie A1	A	395,87	479,00
	PL72F	Patrijspoort vast, aluminium, type PL721, categorie A1	A	437,19	529,00
	PL73F	Patrijspoort vast, aluminium, type PL731, categorie A1	A	486,78	589,00
	PL74F	Patrijspoort vast, aluminium, type PL741, categorie A1	A	569,42	689,00
	PL75F	Patrijspoort vast, aluminium, type PL751, categorie A1	A	511,57	619,00

PL71FA	Patrijspoort vast, helder geanodiseerd aluminium, type PL711, categorie A1	A	395,87	479,00	
PL72FA	Patrijspoort vast, helder geanodiseerd aluminium, type PL721, categorie A1	A	437,19	529,00	
PL73FA	Patrijspoort vast, helder geanodiseerd aluminium, type PL731, categorie A1	A	486,78	589,00	
PL74FA	Patrijspoort vast, helder geanodiseerd aluminium, type PL741, categorie A1	A	569,42	689,00	
PL75FA	Patrijspoort vast, helder geanodiseerd aluminium, type PL751, categorie A1	A	511,57	619,00	
HOR711	Muggenhor voor de PL711	A	17,31	20,95	
HOR721	Muggenhor voor de PL721	A	17,31	20,95	
HOR731	Muggenhor voor de PL731	A	17,31	20,95	
HOR741	Muggenhor voor de PL741	A	17,31	20,95	
HOR751	Muggenhor voor de PL751	A	17,31	20,95	



TYPE PW, CATEGORIE A1





PW201	Patrijspoort, aluminium, type PW201, categorie A1, incl. muggenhor	A	165,29	200,00	
PW211	Patrijspoort, aluminium, type PW211, categorie A1, incl. muggenhor	A	171,90	208,00	
PW221	Patrijspoort, aluminium, type PW221, categorie A1, incl. muggenhor	A	195,04	236,00	
PW201P	Patrijspoort, zwart gepoedercoat aluminium, type PW201, categorie A1, incl. muggenhor	A	165,29	200,00	
PW211P	Patrijspoort, zwart gepoedercoat aluminium, type PW211, categorie A1, incl. muggenhor	A	171,90	208,00	
PW221P	Patrijspoort, zwart gepoedercoat aluminium, type PW221, categorie A1, incl. muggenhor	A	195,04	236,00	
PW20FP	Patrijspoort vast, zwart gepoedercoat aluminium, type PW201, categorie A1	A	165,29	200,00	
PW21FP	Patrijspoort vast, zwart gepoedercoat aluminium, type PW211, categorie A1	A	171,90	208,00	
PW22FP	Patrijspoort vast, zwart gepoedercoat aluminium, type PW221, categorie A1	A	195,04	236,00	
HOR2013	Muggenhor voor de PW201	A	19,79	23,95	
HOR2113	Muggenhor voor de PW211	A	19,79	23,95	
HOR2213	Muggenhor voor de PW221	A	19,79	23,95	

TYPE PM, CATEGORIE A3

290	PM111	Patrijspoort, aluminium, type PM111, categorie A1, incl. muggenhor	A	175,21	212,00	
	PM121	Patrijspoort, aluminium, type PM121, categorie A1, incl. muggenhor	A	186,78	226,00	
	PM131	Patrijspoort, aluminium, type PM131, categorie A1, incl. muggenhor	A	203,31	246,00	
	PM141	Patrijspoort, aluminium, type PM141, categorie A1, incl. muggenhor	A	214,05	259,00	
	PM151	Patrijspoort, aluminium, type PM151, categorie A1, incl. muggenhor	A	222,31	269,00	
	PM161	Patrijspoort, aluminium, type PM161, categorie A1, incl. muggenhor	A	238,84	289,00	
	PM111P	Patrijspoort, zwart gepoedercoat aluminium, type PM111, categorie A1, incl. muggenhor	A	175,21	212,00	
	PM121P	Patrijspoort, zwart gepoedercoat aluminium, type PM121, categorie A1, incl. muggenhor	A	186,78	226,00	
	PM131P	Patrijspoort, zwart gepoedercoat aluminium, type PM131, categorie A1, incl. muggenhor	A	203,31	246,00	
	PM141P	Patrijspoort, zwart gepoedercoat aluminium, type PM141, categorie A1, incl. muggenhor	A	214,05	259,00	
	PM151P	Patrijspoort, zwart gepoedercoat aluminium, type PM151, categorie A1, incl. muggenhor	A	222,31	269,00	
	PM161P	Patrijspoort, zwart gepoedercoat aluminium, type PM161, categorie A1, incl. muggenhor	A	238,84	289,00	
	PM11FP	Patrijspoort vast, zwart gepoedercoat aluminium, type PM111, categorie A1	A	175,21	212,00	
	PM12FP	Patrijspoort vast, zwart gepoedercoat aluminium, type PM121, categorie A1	A	186,78	226,00	
	PM13FP	Patrijspoort vast, zwart gepoedercoat aluminium, type PM131, categorie A1	A	203,31	246,00	
	PM14FP	Patrijspoort vast, zwart gepoedercoat aluminium, type PM141, categorie A1	A	214,05	259,00	
	PM15FP	Patrijspoort vast, zwart gepoedercoat aluminium, type PM151, categorie A1	A	222,31	269,00	
	PM16FP	Patrijspoort vast, zwart gepoedercoat aluminium, type PM161, categorie A1	A	238,84	289,00	
	HOR11	Muggenhor voor de PM111	A	19,79	23,95	
	HOR12	Muggenhor voor de PM121	A	19,79	23,95	
	HOR13	Muggenhor voor de PM131	A	19,79	23,95	
	HOR14	Muggenhor voor de PM141	A	19,79	23,95	
	HOR15	Muggenhor voor de PM151	A	19,79	23,95	
	HOR16	Muggenhor voor de PM161	A	19,79	23,95	

TYPE PZ, CATEGORIE A1

PZ611	Patrijspoort, aluminium, type PZ611, categorie A1, incl. muggenhor	A	171,90	208,00	
PZ621	Patrijspoort, aluminium, type PZ621, categorie A1, incl. muggenhor	A	186,78	226,00	
PZ631	Patrijspoort, aluminium, type PZ631, categorie A1, incl. muggenhor	A	203,31	246,00	
PZ641	Patrijspoort, aluminium, type PZ641, categorie A1, incl. muggenhor	A	214,05	259,00	
PZ651	Patrijspoort, aluminium, type PZ651, categorie A1, incl. muggenhor	A	230,58	279,00	
PZ661	Patrijspoort, aluminium, type PZ661, categorie A1, incl. muggenhor	A	230,58	279,00	
PZ671	Patrijspoort, aluminium, type PZ671, categorie A1, incl. muggenhor	A	263,64	319,00	
PZ611P	Patrijspoort, zwart gepoedercoat aluminium, type PZ611, categorie A1, incl. muggenhor	A	171,90	208,00	
PZ621P	Patrijspoort, zwart gepoedercoat aluminium, type PZ621, categorie A1, incl. muggenhor	A	186,78	226,00	
PZ631P	Patrijspoort, zwart gepoedercoat aluminium, type PZ631, categorie A1, incl. muggenhor	A	203,31	246,00	
PZ641P	Patrijspoort, zwart gepoedercoat aluminium, type PZ641, categorie A1, incl. muggenhor	A	214,05	259,00	
PZ651P	Patrijspoort, zwart gepoedercoat aluminium, type PZ651, categorie A1, incl. muggenhor	A	230,58	279,00	
PZ661P	Patrijspoort, zwart gepoedercoat aluminium, type PZ661, categorie A1, incl. muggenhor	A	230,58	279,00	
PZ671P	Patrijspoort, zwart gepoedercoat aluminium, type PZ671, categorie A1, incl. muggenhor	A	263,64	319,00	

	PZ61FP	Patrijspoort vast, zwart gepoedercoat aluminium, type PZ611, categorie A1, incl. muggenhor	A	171,90	208,00
	PZ62FP	Patrijspoort vast, zwart gepoedercoat aluminium, type PZ621, categorie A1	A	186,78	226,00
	PZ63FP	Patrijspoort vast, zwart gepoedercoat aluminium, type PZ631, categorie A1	A	203,31	246,00
	PZ64FP	Patrijspoort vast, zwart gepoedercoat aluminium, type PZ641, categorie A1	A	214,05	259,00
	PZ65FP	Patrijspoort vast, zwart gepoedercoat aluminium, type PZ651, categorie A1	A	230,58	279,00
	PZ66FP	Patrijspoort vast, zwart gepoedercoat aluminium, type PZ661, categorie A1	A	230,58	279,00
	PZ67FP	Patrijspoort vast, zwart gepoedercoat aluminium, type PZ671, categorie A1	A	263,64	319,00
	HOR61	Muggenhor voor de PZ611	A	19,79	23,95
	HOR62	Muggenhor voor de PZ621	A	19,79	23,95
	HOR63	Muggenhor voor de PZ631	A	19,79	23,95
	HOR64	Muggenhor voor de PZ641	A	19,79	23,95
	HOR65	Muggenhor voor de PZ651	A	19,79	23,95
	HOR66	Muggenhor voor de PZ661	A	19,79	23,95
	HOR67	Muggenhor voor de PZ671	A	19,79	23,95

TYPE PX, CATEGORIE A3

291	PX45	Patrijspoort, aluminium, type PX45, categorie A3, incl. muggenhor	A	238,84	289,00
	PX46	Patrijspoort, aluminium, type PX46, categorie A3, incl. muggenhor	A	247,11	299,00
	PX47	Patrijspoort, aluminium, type PX47, categorie A3, incl. muggenhor	A	255,37	309,00
	PXF	Patrijspoort, aluminium, type PXF, categorie A3, incl. muggenhor	A	321,49	389,00
Nieuw!	PXFF	Patrijspoort vast, zwart gepoedercoat aluminium, type PXFF, categorie A3	A	296,69	359,00
	PX45P	Patrijspoort, zwart gepoedercoat aluminium, type PX45, categorie A3, incl. muggenhor	A	238,84	289,00
	PX46P	Patrijspoort, zwart gepoedercoat aluminium, type PX46, categorie A3, incl. muggenhor	A	247,11	299,00
	PX47P	Patrijspoort, zwart gepoedercoat aluminium, type PX47, categorie A3, incl. muggenhor	A	255,37	309,00
	PXFP	Patrijspoort, zwart gepoedercoat aluminium, type PXF, categorie A3, incl. muggenhor	A	321,49	389,00
	PX45FP	Patrijspoort vast, zwart gepoedercoat aluminium, type PX45, categorie A3	A	238,84	289,00
	PX46FP	Patrijspoort vast, zwart gepoedercoat aluminium, type PX46, categorie A3	A	247,11	299,00
	PX47FP	Patrijspoort vast, zwart gepoedercoat aluminium, type PX47, categorie A3	A	255,37	309,00
	PXFFP	Patrijspoort vast, zwart gepoedercoat aluminium, type PXF, categorie A3	A	321,49	389,00
	HOR45	Muggenhor voor de PX45	A	19,79	23,95
	HOR46	Muggenhor voor de PX46	A	19,79	23,95
	HOR47	Muggenhor voor de PX47	A	19,79	23,95
	HORPXF	Muggenhor voor de PXF	A	19,79	23,95

TYPE PA

	VP000044	Set van twee vervangingsknoppen voor patrijspoorten	ST	2,64	3,20
--	-----------------	-----------------------------------------------------	----	------	------

PATRIJSPOORTEN VAN ROESTVAST STAAL (AISI 316)**TYPE PMS**

292	PMS23A1	Patrijspoort RVS 316 type PMS23, A1 kwaliteit, incl. muggenhor	A	354,55	429,00
	PMS24A1	Patrijspoort RVS 316 type PMS24, A1 kwaliteit, incl. muggenhor	A	395,87	479,00
	HOR23S	Muggenhor voor de PMS23	A	51,24	62,00
	HOR24S	Muggenhor voor de PMS24	A	52,89	64,00

TYPE PWS

	PWS31A1	Patrijspoort RVS 316 type PWS31, A1 kwaliteit, incl. muggenhor	A	255,37	309,00
	PWS32A1	Patrijspoort RVS 316 type PWS32, A1 kwaliteit, incl. muggenhor	A	288,43	349,00
	HOR31S	Muggenhor voor de PWS31	A	51,24	62,00
	HOR32S	Muggenhor voor de PWS32	A	52,89	64,00

TYPE PQ

293	PQ51	Patrijspoort RVS 316, type PQ51, incl. muggenhor	B	128,93	156,00
	PQ52	Patrijspoort RVS 316, type PQ52, incl. muggenhor	B	138,02	167,00
	PQ53	Patrijspoort RVS 316, type PQ53, incl. muggenhor	B	162,81	197,00
	HORPQ51	Muggenhor voor de PQ51	B	19,79	23,95
	HORPQ52	Muggenhor voor de PQ52	B	19,79	23,95
	HORPQ53	Muggenhor voor de PQ53	B	19,79	23,95

TYPE PA

	PA3016	Aluminium patrijspoort ondiep profiel 315 x 180 mm	A	222,31	269,00
	PA3517	Aluminium patrijspoort ondiep profiel 368 x 193 mm	A	222,31	269,00
	PA4116	Aluminium patrijspoort ondiep profiel 425 x 180 mm	A	238,84	289,00
	PA4317	Aluminium patrijspoort ondiep profiel 453 x 193 mm	A	238,84	289,00
	PA6317	Aluminium patrijspoort ondiep profiel 652 x 193 mm	A	313,22	379,00
	WSP00K	Scherf voor WPO00 zwart	A	22,27	26,95
	WSP01K	Scherf voor WPO01 zwart	A	22,27	26,95

WSP02K	Schermbord voor WPO02 zwart	A	25,58	30,95	
WSP03K	Schermbord voor WPO03 zwart	A	25,58	30,95	
WSP04K	Schermbord voor WPO04 zwart	A	28,06	33,95	

TYPE PLANUS

294	PLA23L	Planus ventilatieluik type 2323	A	138,84	168,00	
	PLA30L	Planus ventilatieluik type 3023	A	157,85	191,00	
	PLA34L	Planus ventilatieluik type 3421	A	157,85	191,00	
	PLA32L	Planus deklui type 4532	A	238,84	289,00	
	PLA40L	Planus deklui type 4040	A	247,11	299,00	
	PLA45L	Planus vluchtlui type 4545	A	263,64	319,00	
	PLA50L	Planus vluchtlui type 5050	A	313,22	379,00	
	HLLRBG	Kit met sloten voor alle luiken	ST	20,62	24,95	

VLUCHT-DEK- EN VENTILATIELUIKEN TYPE ALTUS

295	ALT6363SL	Altus vluchtlui type 6363 (inbouwmaat 627 x 627 mm)	A	709,92	859,00	
	ALT5151SL	Altus vluchtlui type 5151 (inbouwmaat 511 x 511 mm)	A		552,89	
	ALT4747SL	Altus vluchtlui type 4747 (inbouwmaat 470 x 470 mm)	A		511,57	
	ALTD520SL	Altus vluchtlui type D520 (inbouwmaat 518 x 450 mm)	A		635,54	
	ALTR520SL	Altus vluchtlui type R520 (inbouwmaat D= 518 mm)	A	594,21	719,00	
	ALT4242SL	Altus deklui type 4242 (inbouwmaat 421 x 421 mm)	A	461,98	559,00	
	ALT5038SL	Altus deklui type 5038 (inbouwmaat 507 x 377 mm)	A	445,45	539,00	
	ALT4633SL	Altus deklui type 4633 (inbouwmaat 457 x 327 mm)	A	437,19	529,00	
	ALTR420SL	Altus deklui type R420 (inbouwmaat D=417 mm)	A	569,42	689,00	
	ALT2626SL	Altus ventilatieluik type 2626 (inbouwmaat 260 x 260 mm)	A	238,84	289,00	
	ALTD420SL	Altus ventilatieluik type D420 (inbouwmaat 417 x 252 mm)	A	569,42	689,00	
	ALA3520L	Altus vluchtlui type 3520 (inbouwmaat 347 x 202 mm)* let op, iets afwijkende afwerking	A	263,64	319,00	
	ALA46TL	Altus vluchtlui type 46 trapezium (inbouwmaat 464 x 607 x 378 mm)* let op, iets afwijkende afwerking	A	536,36	649,00	
	ALA41TL	Altus vluchtlui type 41 trapezium (inbouwmaat 434 x 528 x 362 mm)* let op, iets afwijkende afwerking	A		Prijs op aanvraag	
	ALA56TL	Altus vluchtlui type 56 trapezium (inbouwmaat 557 x 588 x 436 mm)* let op, iets afwijkende afwerking	A		Prijs op aanvraag	
	ALA080TL	Altus vluchtlui type 80 trapezium (inbouwmaat 804 x 644 x 497 mm)* let op, iets afwijkende afwerking	A		Prijs op aanvraag	



VLUCHT-DEK- EN VENTILATIELUIKEN TYPE LIBERO

296	LIB6232L	Libero vluchtlui type 6262 (radius 32 mm)	A	643,80	779,00	
	LIB6255L	Libero vluchtlui type 6262 (radius 55 mm)	A	643,80	779,00	
	LIB5032L	Libero vluchtlui type 5050 (radius 32 mm)	A	552,89	669,00	
	LIB5055L	Libero vluchtlui type 5050 (radius 55 mm)	A	552,89	669,00	
	LIB4155L	Libero vluchtlui t type 4141 mm (radius 55 mm)	A	503,31	609,00	
	LIB3732L	Libero deklui type 5037 (radius 32 mm)	A	478,51	579,00	
	LIB3755L	Libero deklui type 5037 (radius 55 mm)	A	478,51	579,00	
	LIB3232L	Libero deklui type 4532 (radius 32 mm)	A	437,19	529,00	
	LIB3255L	Libero deklui type 4532 (radius 55 mm)	A	437,19	529,00	
	LIB3432L	Libero ventilatieluik type 3432 (radius 32 mm)	A	288,43	349,00	
	LIB2032L	Libero ventilatieluik type 2020 (radius 32 mm)	A	230,58	279,00	

VLUCHT-DEK- EN VENTILATIELUIKEN TYPE MAGNUS

297	MAG6363SL	Magnus vluchtlui type 6363 (inbouwmaat 627 x 627 mm)	A	776,03	939,00	
	MAG5151SL	Magnus vluchtlui type 5151 (inbouwmaat 507 x 507 mm)	A	594,21	719,00	
	MAG4747SL	Magnus vluchtlui type 4747 (inbouwmaat 470 x 470 mm)	A	569,42	689,00	
	MAG4242SL	Magnus deklui type 4242 (inbouwmaat 421 x 421 mm)	A	503,31	609,00	
	MAG5038SL	Magnus deklui type 5038 (inbouwmaat 507 x 377 mm)	A	478,51	579,00	
	MAG4633SL	Magnus deklui type 4633 (inbouwmaat 457 x 327 mm)	A	478,51	579,00	
	MAG2626SL	Magnus ventilatieluik type 2626 (inbouwmaat 260 x 260 mm)	A	263,64	319,00	
	MAA3520L	Magnus vluchtlui type 3520 (inbouwmaat 347 x 202 mm)* let op, iets afwijkende afwerking	A	271,90	329,00	

FLUSH DEK- VLUCHTLUIK TYPE FGH

298	FGH6363	Vluchtlui type 6363	A	685,12	829,00	
	FGH5151	Vluchtlui type 5151	A	602,48	729,00	
	FGH4633	Deklui type 4633	A	461,98	559,00	
	FGH5139	Deklui type 5139	A	602,48	729,00	
	FGH2626	Deklui type 2626	A	379,34	459,00	
	FGH4444	Deklui type 4444	A	528,10	639,00	
	FGHF6363	Volledig vlak vluchtlui type 6363	A	693,39	839,00	
	FGHF5151	Volledig vlak vluchtlui type 5151	A	635,54	769,00	
	FGHF4444	Volledig vlak deklui type 4444	A	552,89	669,00	
	FGHF2626	Volledig vlak deklui type 2626	A	412,40	499,00	

HORREN VOOR PLANUS/ALTUS/MAGNUS/FGH LUIKEN

299	HCM23	Muggenhor / tegenflens voor Planus 23	A	89,26	108,00
	HCM30	Muggenhor / tegenflens voor Planus 30	A	100,00	121,00
	HCM34	Muggenhor / tegenflens voor Planus 34	A	108,26	131,00
	HCM32	Muggenhor / tegenflens voor Planus 32	A	123,97	150,00
	HCM40	Muggenhor / tegenflens voor Planus 40	A	126,45	153,00
	HCM45	Muggenhor / tegenflens voor Planus 45	A	130,58	158,00
	HCM50	Muggenhor / tegenflens voor Planus 50	A	138,02	167,00
	HCM2626	Muggenhor / tegenflens Altus / Magnus 2626	A	100,00	121,00
	HCM4242	Muggenhor / tegenflens Altus/Magnus 4242	A	117,36	142,00
	HCM4444	Muggenhor / tegenflens FGH 4444	A	122,31	148,00
	HCM4633	Muggenhor / tegenflens Altus/Magnus 4633	A	126,45	153,00
	HCM4747	Muggenhor / tegenflens Altus/Magnus 4747	A	138,02	167,00
	HCM5038	Muggenhor / tegenflens Altus/Magnus 5038	A	133,06	161,00
	HCM5151	Muggenhor / tegenflens Altus/Magnus 5151	A	148,76	180,00
	HCM6363	Muggenhor / tegenflens Altus/Magnus 6363	A	172,73	209,00
	HCMD420	Muggenhor / tegenflens Altus D420	A	150,41	182,00
	HCMD520	Muggenhor / tegenflens Altus D520	A	171,90	208,00
	HCMR420	Muggenhor / tegenflens Altus R420	A	142,98	173,00
	HCMR520	Muggenhor / tegenflens Altus R520	A	171,90	208,00

HORREN VOOR LIBERO LUIKEN

	HCM2020	Muggenhor / tegenflens voor Libero 2020,, radius 32 mm	A	110,74	134,00
	HCM3420	Muggenhor / tegenflens voor Libero 3420,, radius 55 mm	A	123,14	149,00
	HCM4141	Muggenhor / tegenflens voor Libero 4141,, radius 55 mm	A	123,14	149,00
	HCM4532	Muggenhor / tegenflens voor Libero 4532,, radius 55 mm	A	128,93	156,00
	HCM5037	Muggenhor / tegenflens voor Libero 5037,, radius 55 mm	A	130,58	158,00
	HCM5050	Muggenhor / tegenflens voor Libero 5050,, radius 55 mm	A	145,45	176,00
	HCM6262	Muggenhor / tegenflens voor Libero 6262,, radius 55 mm	A		167,77
	HMB2626	Muggenhor en blinderingsstelsel voor Altus/ Magnus/ FGH 2626	A	167,77	203,00
	HMB4242	Muggenhor en blinderingsstelsel voor Altus/ Magnus 4242	A	190,08	230,00
	HMB4444	Muggenhor en blinderingsstelsel voor Altus/ Magnus 4444	A	195,04	236,00
	HMB4633	Muggenhor en blinderingsstelsel voor Altus/ Magnus 4633	A	201,65	244,00
	HMB5038	Muggenhor en blinderingsstelsel voor Altus/ Magnus 5038	A	205,79	249,00
	HMB5139	Muggenhor en blinderingsstelsel voor Altus/ Magnus 5139	A	214,05	259,00
300	HOP380	Hopper met Ø 380 mm uitneembaar dubbelglas	A	891,74	1079,00
	HOP459	Hopper met Ø 459 mm uitneembaar dubbelglas	A	1.015,70	1229,00
305	FBH	Alle FBH's worden op maat gemaakt. Neem a.u.b. contact op met glazing@vetus.com voor een offerte.	K		Prijs op aanvraag

**RUITENWISSERS
RUITENWISSER MOTOREN**



306	RW01A	Ruitenwissermotor 12/24 V lange as 2", type RWS, met parkeerstand en 2 snelheden	B	84,30	102,00
	RW02A	Ruitenwissermotor 24 V lange as 2", type RWS, met parkeerstand en 2 snelheden	B	84,30	102,00
	RW08A	Ruitenwissermotor 12/24 V korte as 1", type RWS, met parkeerstand en 2 snelheden	B	84,30	102,00
	RW09A	Ruitenwissermotor 24 V korte as 1", type RWS, met parkeerstand en 2 snelheden	B	84,30	102,00
	DIN1250	Ruitenwissermotor 12/24 V lange as 2", met parkeerstand en 2 snelheden, met DIN aansluiting	B	84,30	102,00
	DIN2450	Ruitenwissermotor 24 V lange as 2", met parkeerstand en 2 snelheden, met DIN aansluiting	B	84,30	102,00
	DIN1225	Ruitenwissermotor 12/24 V korte as 1", met parkeerstand en 2 snelheden, met DIN aansluiting	B	84,30	102,00
	DIN2425	Ruitenwissermotor 24 V korte as 1", met parkeerstand en 2 snelheden, met DIN aansluiting	B	84,30	102,00
	RWCG	Kunststof huis voor ruitenwissermotor, grijs	B	31,36	37,95

RUITENWISSER ARMEN (KUNSTSTOF)



308	RWAS	Ruitenwisserarm, L= 280 - 366 mm	B	30,54	36,95
	RWAL	Ruitenwisserarm, L= 395 - 481 mm	B	34,67	41,95
	RWAX	Ruitenwisserarm, L= 473 - 559 mm	B	37,15	44,95
	RWAD	Ruitenwisserarm, parallel, L= 308 - 393 mm	B	102,48	124,00
	RWADX	Ruitenwisserarm, parallel, L= 386 - 471 mm.	B	108,26	131,00
	RWCG	Kunststof huis voor ruitenwissermotor, grijs	B	31,36	37,95
	RWASET	Aansluitset voor parallel wissers	ST	26,40	31,95
	DINPS	Ruitenwisserarm, L= 280 - 366 mm, met DIN aansluiting	B	31,36	37,95
	DINPL	Ruitenwisserarm, L= 395 - 481 mm, met DIN aansluiting	B	34,67	41,95

DINPX	Ruitenwisserarm, L= 473 - 559 mm, met DIN aansluiting	B	37,15	44,95	
DINPD	Ruitenwisserarm, parallel, L= 308 - 393 mm, met DIN aansluiting	B	102,48	124,00	
DINPDX	Ruitenwisserarm, parallel, L= 386 - 471 mm., met DIN aansluiting	B	108,26	131,00	



RUITNWISSER BLADEN (ROESTVASTSTAAL AISI 316)

WBB30	Wisserblad, roestvast staal, zwart gecoat, L= 305 mm.	B	14,83	17,95	
WBB41	Wisserblad, roestvast staal, zwart gecoat, L= 410 mm.	B	14,83	17,95	
WBB51	Wisserblad, roestvast staal, zwart gecoat, L= 508 mm.	B	21,45	25,95	
WBS30	Wisserblad, roestvast staal, L= 305 mm.	B	15,66	18,95	
WBS41	Wisserblad, roestvast staal, L= 410 mm.	B	15,66	18,95	
WBS51	Wisserblad, roestvast staal, L= 508 mm.	B	21,45	25,95	



RUITNWISSER ARMEN (ROESTVASTSTAAL AISI 316)

SSAS	Ruitenwisserarm, roestvast staal, L= 280 - 366 mm	B	75,21	91,00	
SSAL	Ruitenwisserarm, roestvast staal, L= 395 - 481 mm	B	76,86	93,00	
SSAX	Ruitenwisserarm, roestvast staal, L= 473 - 559 mm.	B	86,78	105,00	
SSAD	Ruitenwisserarm, roestvast staal, parallel, L= 308 - 393 mm.	B	174,38	211,00	
SSADX	Ruitenwisserarm, roestvast staal, parallel, L= 386 - 471 mm.	B	179,34	217,00	
DINSS	Ruitenwisserarm, roestvast staal, L= 280 - 366 mm, met DIN aansluiting	B	75,21	91,00	
DINSL	Ruitenwisserarm, roestvast staal, L= 395 - 481 mm, met DIN aansluiting	B	76,86	93,00	
DINSX	Ruitenwisserarm, roestvast staal, L= 473 - 559 mm, met DIN aansluiting	B	86,78	105,00	
DINSD	Ruitenwisserarm, roestvast staal, parallel, L= 308 - 393 mm, met DIN aansluiting	B	174,38	211,00	
DINSDX	Ruitenwisserarm, roestvast staal, parallel, L= 386 - 471 mm, met DIN aansluiting	B	179,34	217,00	

RUITNWISSER (VOOR KLEINE BOTEN)

309	ORW12SET	Ruitenwissermotor 12 Volt, (incl. arm en blad)	C	95,87	116,00	
Nieuw!	ORW12BL	Ruitenwissers voor ORW12SET	C	13,18	15,95	
Nieuw!	ORW12WA	Ruitenwisserarm voor ORW12SET	ST	15,66	18,95	
	WBB30	Wisserblad, roestvast staal, zwart gecoat, L= 305 mm.	B	14,83	17,95	

SLINGERRUITEN

SLR30012	Slingerruit Ø 300 mm. 12 Volt	A	1.371,07	1659,00	
SLR30024	Slingerruit Ø 300 mm. 24 Volt	A	1.371,07	1659,00	
SLR35012	Slingerruit Ø 350 mm. 12 Volt	A	1.941,32	2349,00	
SLR35024	Slingerruit Ø 350 mm. 24 Volt	A	1.941,32	2349,00	



RUITNWISSERS (VOOR HET ZWARE WERK)

310	HDM12DL	Heavy duty wisser motor, lange as, instelbare wishoek, 12 Volt	B	461,98	559,00	
	HDM24DL	Heavy duty wisser motor, lange as, instelbare wishoek, 24 Volt	B	461,98	559,00	
	HDM12DS	Heavy duty wisser motor, korte as, instelbare wishoek, 12 Volt	B	461,98	559,00	
	HDM24DS	Heavy duty wisser motor, korte as, instelbare wishoek, 24 Volt	B	461,98	559,00	
	HDMCOVER	Afdekkap voor wissermotor	A	28,88	34,95	
	SHDA400	Parallel ruitenwisserarm, roestvaststaal 316, L= 401 - 486 mm	B	157,02	190,00	
	SHDA500	Parallel ruitenwisserarm, roestvaststaal 316, L= 508 mm	B	159,50	193,00	
	SHDA760	Parallel ruitenwisserarm, roestvaststaal 316, L= 762 mm	B	181,82	220,00	
311	WBS46H	Wisserblad roestvast staal 316, hoogglans gepolijst, L= 460 mm	B	35,50	42,95	
	WBS56H	Wisserblad roestvast staal 316, hoogglans gepolijst, L= 560 mm	B	42,15	51,00	
	WBS66H	Wisserblad roestvast staal 316, hoogglans gepolijst, L= 660 mm	B	46,28	56,00	
	WBB46H	Wisserblad roestvast staal 316, zwart gecoat, L= 460 mm	B	28,06	33,95	
	WBB56H	Wisserblad roestvast staal 316, zwart gecoat, L= 560 mm	B	31,36	37,95	
	WBB66H	Wisserblad roestvast staal 316, zwart gecoat, L= 660 mm	B	34,67	41,95	

RUITENSPROEIER

WWFR12	Sproei-installatie 12 Volt, compleet, incl. reservoir en pomp	B	83,47	101,00	
WWFR24	Sproei-installatie 24 Volt, compleet, incl. reservoir en pomp	B	83,47	101,00	
HDSXTB	Uitbreidingskit sproei-installatie, voor tweede wisser, 12/24 Volt	B	59,50	72,00	

RUITNWISSER BEDIENING



	HDMSW	Drie-standenschakelaar voor ruitenwissermotoren (niet voor ORW)	B	22,27	26,95	
	HDMSW2	Drie-standenschakelaar voor ruitenwissermotoren (niet voor ORW)	B	42,15	51,00	
312	HDS12B	Ruitensproeierset (12 V) voor ruitenwissers	B	164,46	199,00	
	HDS24B	Ruitensproeierset (24 V) voor ruitenwissers	B	164,46	199,00	
	HDSXTB	Uitbreidingskit sproei-installatie, voor tweede wisser, 12/24 Volt	B	59,50	72,00	
	MARBO	Regensensor 12/24 Volt, incl. schakelaar	B	263,64	319,00	

	MARBO2	Extra regensensor 12/24 Volt	B	230,58	279,00
	WPANEL	Regelunit 12/24 Volt, voor maximaal 5 wissermotoren, incl. schakelaars	B	528,10	639,00
	RWPANEL2	Regelunit 12/24 Volt, voor maximaal 3 wissermotoren, incl. paneel	B	478,51	579,00

VENTILATIE**DEKVENTILATOREN**

	317	UFO	Dekventilator type UFO (incl. kunststof rooster)	C	65,29	79,00
		UFOTR	Dekventilator type UFO TRANS(incl. kunststof rooster)	C	74,38	90,00
		UFO2	Afsluitbare dekventilator type UFO 2,(incl. kunststof afwerking)	C	104,13	126,00

PADDESTOELVENTILATOREN (Roestvast staal AISI 316)

		DARTAGN1	Paddestoelventilator type D'ARTAGNAN 1 (incl. muggenhor en kunststof afwerking)	C	106,61	129,00
		ATHOS1	Paddestoelventilator type ATHOS 1 (incl. muggenhor en kunststof afwerking)	C	85,12	103,00
		PORTOS1	Paddestoelventilator type PORTOS 1 (incl. muggenhor en kunststof afwerking)	C	64,46	78,00



ROESTVAST STALEN (AISI 316) LUCHTSCHHELP



	318	TYP75	Luchtschelp type Typhoon Ø 75 mm	C	128,10	155,00
		TYP100	Luchtschelp type Typhoon Ø 100 mm	C	155,37	188,00
		SCIROCCO	Luchtschelp type SCIROCCO (incl. kunststof onderplaat)	C	47,93	58,00



ELEKTRISCHE VENTILATOREN

	319	FAN12	Elektrische ventilator 12 Volt	C	90,91	110,00
		FAN24	Elektrische ventilator 24 Volt	C	90,91	110,00

AFZUIGVENTILATOREN

		TWINLINEA	Afzuigventilator type TWINLINE, 12 Volt, 2,8 Amp., capaciteit 4 m³/min.	B	50,41	61,00
		TWINLINEB	Afzuigventilator type TWINLINE, 12 Volt, 2,8 Amp., capaciteit 4 m³/min.	B	55,37	67,00
		TWINLINEC	Afzuigventilator type TWINLINE, 24 Volt, 2,8 Amp., capaciteit 4 m³/min.	B	51,24	62,00
		TWINLINED	Afzuigventilator type TWINLINE, 24 Volt, 2,8 Amp., capaciteit 4 m³/min.	B	55,37	67,00

	320	VENT7612A	Afzuigventilator type VENT, 12 Volt, 8 Amp., capaciteit 4 m³/min.	A	105,79	128,00
		VENT7624A	Afzuigventilator type VENT, 24 Volt, 4 Amp., capaciteit 4 m³/min.	A	105,79	128,00
		VENT10212	Afzuigventilator type VENT, 12 Volt, 8 Amp., capaciteit 4 m³/min.	A	105,79	128,00
		VENT10224	Afzuigventilator type VENT, 24 Volt, 4 Amp., capaciteit 4 m³/min.	A	105,79	128,00
		VENTKITA	Flens voor in-line slangconnectie voor VENT76A	B	8,22	9,95
		VENTKITB	Adapterset voor de VENT102	B	8,22	9,95

















	321	VENT17812	Afzuigventilator 12 V, # Ø 178 mm	A	176,86	214,00
		VENT17824	Afzuigventilator ventilator 24 V, # Ø 178 mm	A	176,86	214,00
		BLHOSE310A	Blower-/ ventilatorslang, inw. Ø 76 +/- 3 mm (3") (rol van 10 meter)	C	73,55	89,00
		BLHOSE410A	Blower-/ ventilatorslang, inw. Ø 102 mm (4") (rol van 10 meter)	C	85,95	104,00
		VHOSE152	Slang voor directe luchtvoorziening Ø 152 mm (prijs per meter)	A	61,98	75,00
		VHOSE178	Slang voor afzuigventilator Ø 178 mm. (prijs per meter)	A	61,98	75,00

LUCHTHAPPERS VAN SILICONEN

	322	TRAMON	Luchthapper Ø 75 mm inw, type TRAMON2, kunststof (incl. draaibare kunststof ring)	B	52,89	64,00
		TRAMONS	Luchthapper Ø 75 mm inw, type TRAMON S, (incl. vaste kunststof ring)	B	43,80	53,00
		LIBEC	Luchthapper Ø 75 mm inw, type LIBEC2, kunststof (incl. draaibare kunststof ring)	B	55,37	67,00
		LIBECS	Luchthapper Ø 75 mm inw, type LIBEC S, (incl. vaste kunststof ring)	B	42,15	51,00
		CHINOOK	Luchthapper Ø 100 mm inw, type CHINOOK2, kunststof (incl. draaibare kunststof ring)	B	59,50	72,00
		CHINOOKS	Luchthapper Ø 100 mm inw, type CHINOOK S, (incl. vaste kunststof ring)	B	50,41	61,00
		SAMOEN	Luchthapper Ø 125 mm inw, type SAMOEN2, kunststof (incl. draaibare kunststof ring)	B	85,95	104,00
		SAMOENS	Luchthapper Ø 125 mm inw, type SAMOEN S, (incl. vaste kunststof ring)	B	70,25	85,00
	Nieuw!	BORE75	Luchthapper Ø 75 mm inw, type BORE75, (incl. vaste RVS 316 ring)	B	152,07	184,00
	Nieuw!	BORE100	Luchthapper Ø 100 mm inw, type BORE100, (incl. vaste RVS 316 ring)	B	171,07	207,00
	Nieuw!	BORE125	Luchthapper Ø 125 mm inw, type BORE125, (incl. vaste RVS 316 ring)	B	214,05	259,00

LUCHTHAPPERS RVS AISI 316

	323	DON316R	Luchthapper Ø 75 mm inw, type Donald, RVS316/rood (incl. ring en moer)	B	280,17	339,00
		DON316WR	Luchthapper Ø 75 mm inw, type Donald, RVS316/wit (incl. ring en moer)	B	280,17	339,00
		JER316R	Luchthapper Ø 75 mm inw, type Jerry, RVS316/rood (incl. ring en moer)	B	280,17	339,00
		JER316WR	Luchthapper Ø 75 mm inw, type Jerry, RVS316/wit (incl. ring en moer)	B	280,17	339,00
		TOM316R	Luchthapper Ø 100 mm inw, type Tom, RVS316/rood (incl. ring en moer)	B	371,07	449,00
		TOM316WR	Luchthapper Ø 100 mm inw, type Tom, RVS316/wit (incl. ring en moer)	B	371,07	449,00
		YOG316R	Luchthapper Ø 125 mm inw, type Yogi, RVS316/rood (incl. ring en moer)	B	486,78	589,00
		YOG316WR	Luchthapper Ø 125 mm inw, type Yogi, RVS316/wit (incl. ring en moer)	B	486,78	589,00

WATERKERINGEN VOOR LUCHTHAPPERS							
324	BOX75	Waterkering voor luchthapper Ø 75 mm inw.	B	255,37	309,00		
	BOX100	Waterkering voor luchthapper Ø 100 mm inw.	B	354,55	429,00		
	BOX125	Waterkering voor luchthapper Ø 125 mm inw.	B	428,93	519,00		
	BOXS75	Waterkering voor luchthapper van roestvrij staal Ø 75 mm ID.	B	304,96	369,00		
	BOXS100	Waterkering voor luchthapper van roestvrij staal Ø 100 mm ID.	B	387,60	469,00		
	BOXAD75	Waterkering adapter voor montage op grotere dekdiktes, voor BOX75 en BOXS75	B	136,36	165,00		
	BOXAD100	Waterkering adapter voor montage op grotere dekdiktes, voor BOX100 en BOXS100	B	194,21	235,00		
	BOXAD125	Waterkering adapter voor montage op grotere dekdiktes, voor BOX125 en BOXS125	B	247,11	299,00		
	325	YBOX	Waterkering voor YOGI / SAMOEN, incl. paddestoelventilator	B	145,45	176,00	
		TBOX	Waterkering voor TOM / CHINOOK, incl. paddestoelventilator	B	111,57	135,00	
DJBOX		Waterkering voor DONALD / JERRY / TRAMON / LIBEC, incl. paddestoelventilator	B	95,04	115,00		
							
ROESTVAST STALEN (AISI 316) RINGEN							
	RING75	Draaibare ring en moer RVS 316, voor luchthapper Donald/Jerry	B	122,31	148,00		
	RING100	Draaibare ring en moer RVS 316, voor luchthapper Tom	B	138,02	167,00		
	RING125	Draaibare ring en moer RVS 316, voor luchthapper Yogi	B	174,38	211,00		
AFDEKPLAAT EN MUGGENHOR							
	SET75	Afdekplaat en muggenhor RVS316, voor luchthapper Ø 75 mm inw.	B	21,45	25,95		
	SET100	Afdekplaat en muggenhor RVS316, voor luchthapper Ø 100 mm inw.	B	23,93	28,95		
	SET125	Afdekplaat en muggenhor RVS316, voor luchthapper Ø 125 mm inw.	B	26,40	31,95		
VENTILATIEPOORTEN							
326	ASV020A	Ventilatiepoort type ASV 20	A	110,74	134,00		
	ASV025A	Ventilatiepoort type ASV 25	A	117,36	142,00		
	ASV030A	Ventilatiepoort type ASV 30	A	128,93	156,00		
	ASV040A	Ventilatiepoort type ASV 40	A	142,98	173,00		
	ASV050A	Ventilatiepoort type ASV 50	A	172,73	209,00		
	ASV060A	Ventilatiepoort type ASV 60	A	179,34	217,00		
	ASV070A	Ventilatiepoort type ASV 70	A	184,30	223,00		
	ASV080A	Ventilatiepoort type ASV 80	A	190,08	230,00		
	ASV090A	Ventilatiepoort type ASV 90	A	195,04	236,00		
	ASV100A	Ventilatiepoort type ASV 100	A	214,05	259,00		
	ASV125A	Ventilatiepoort type ASV 125	A	222,31	269,00		
	ASV150A	Ventilatiepoort type ASV 150	A	280,17	339,00		
	SSV090	Ventilatiepoort type SSV 90	A	263,64	319,00		
	SSV100	Ventilatiepoort type SSV 100	A	288,43	349,00		
	SSV125	Ventilatiepoort type SSV 125	A	288,43	349,00		
	SSV150	Luchtaanzuigpoort type SSV 150	A	354,55	429,00		
	SSVL090	Ventilatiepoort type SSVL 90	A	280,17	339,00		
	SSVL100	Ventilatiepoort type SSVL 100	A	288,43	349,00		
	SSVL125	Ventilatiepoort type SSVL 125	A	321,49	389,00		
	SSVL150	Ventilatiepoort type SSVL 150	A	354,55	429,00		
	ASVREC20	Rechthoekige ventilatiepoort type ASVREC 20	A	97,52	118,00		
	ASVREC30	Rechthoekige ventilatiepoort type ASVREC 30	A	114,05	138,00		
	ASVREC40	Rechthoekige ventilatiepoort type ASVREC 40	A	126,45	153,00		
	ASVREC50	Rechthoekige ventilatiepoort type ASVREC 50	A	145,45	176,00		
	ASVREC60	Rechthoekige ventilatiepoort type ASVREC 60	A	150,41	182,00		
	ASVREC70	Rechthoekige ventilatiepoort type ASVREC 70	A	155,37	188,00		
	ASVREC80	Rechthoekige ventilatiepoort type ASVREC 80	A	157,85	191,00		
	328	DBOX020	Doradebox voor ventilatiepoort type 20	A	45,45	55,00	
		DBOX025	Doradebox voor ventilatiepoort type 25	A	46,28	56,00	
		DBOX030	Doradebox voor ventilatiepoort type 30	A	50,41	61,00	
DBOX040		Doradebox voor ventilatiepoort type 40	A	52,07	63,00		
DBOX050		Doradebox voor ventilatiepoort type 50	A	58,68	71,00		
DBOX060		Doradebox voor ventilatiepoort type 60	A	61,98	75,00		
DBOX070		Doradebox voor ventilatiepoort type 70	A	66,94	81,00		
DBOX080		Doradebox voor ventilatiepoort type 80	A	71,07	86,00		
DBOX090		Doradebox voor ventilatiepoort type 90	A	72,73	88,00		
DBOX100		Doradebox voor ventilatiepoort type 100	A	77,69	94,00		
DBOX125		Doradebox voor ventilatiepoort type 125	A	87,60	106,00		

	DBOX150	Doradebox voor ventilatiepoort type 150	A	92,56	112,00
	ERV110A	Ronde luchtanzuigpoort met roestvast stalen rooster en kunststof huis	A	71,90	87,00
	CCHOSE16	Slang voor gesloten klimaatsystemen, Ø 16 mm (Rol van 20 meter, prijs per meter)	C	26,40	31,95
	CCHOSE25	Slang voor gesloten klimaatsystemen, Ø 256 mm (Rol van 20 meter, (prijs per meter)	C	33,84	40,95

MAXWELL

TDC = total deck clearance / maximale dekdikte

CW = clockwise version, draairichting bij anker op is met de klok mee

ACW = anti clockwise version, draairichting bij anker op is tegen de klok in

RC SERIE

RC6 VERTIKALE ANKERLIEREN VOOR TOUW/KETTING EN ALLEEN KETTING

Alle onderstaande ankerlieren worden geleverd incl. motor, overbrenging en relais. elektrische accessoires dienen apart besteld te worden (zie pagina 318)

RC6 geschikt voor 6-7 mm (1/4") ketting en 12 mm (1/2") Nylon lijn

334	P102569	RC6, 12V, 500W CW	D	999,17	1209,00
	P102570	RC6, 24V, 500W CW	D	999,17	1209,00

RC8 VERTIKALE ANKERLIEREN VOOR TOUW/KETTING EN ALLEEN KETTING

RC8 geschikt voor 6-7 mm (1/4") ketting en 12 mm (1/2") Nylon lijn

336	P102550	RC8-6, 12V, 600W 65TDC CW Met kettingwiel	D	1.180,99	1429,00
	P102551	RC8-6, 24V, 600W 65TDC CW Met kettingwiel	D	1.180,99	1429,00
	P102552	RC8-6, 12V, 600W 65TDC CW Met kettingwiel + kaapstander	D	1.362,81	1649,00
	P102553	RC8-6, 24V, 600W 65TDC CW Met kettingwiel + kaapstander	D	1.362,81	1649,00
	P102554	RC8-6, 12V, 600W 165TDC CW Met kettingwiel	D	1.412,40	1709,00
	P102555	RC8-6, 24V, 600W 165TDC CW Met kettingwiel	D	1.412,40	1709,00
	P102556	RC8-6, 12V, 600W 165TDC CW Met kettingwiel + kaapstander	D	1.544,63	1869,00
	P102557	RC8-6, 24V, 600W 165TDC CW Met kettingwiel + kaapstander	D	1.544,63	1869,00

RC8 geschikt voor 6-7 mm (1/4") ketting en 14-16 mm (9/16-5/8") Nylon lijn

	P102558	RC8-8, 12V, 1000W 65TDC CW Met kettingwiel	D	1.552,89	1879,00
	P102559	RC8-8, 24V, 1000W 65TDC CW Met kettingwiel	D	1.552,89	1879,00
	P102560	RC8-8, 12V, 1000W 65TDC CW Met kettingwiel + kaapstander	D	1.734,71	2099,00
	P102561	RC8-8, 24V, 1000W 65TDC CW Met kettingwiel + kaapstander	D	1.734,71	2099,00
	P102562	RC8-8, 12V, 1000W 165TDC CW Met kettingwiel	D	1.552,89	1879,00
	P102563	RC8-8, 24V, 1000W 165TDC CW Met kettingwiel	D	1.552,89	1879,00
	P102564	RC8-8, 12V, 1000W 165TDC CW Met kettingwiel + kaapstander	D	2.023,97	2449,00
	P102565	RC8-8, 24V, 1000W 165TDC CW Met kettingwiel + kaapstander	D	2.023,97	2449,00
	P105832	RC8-8, 12V, 6 mm kettingwiel 1/4" 65TDC	D	1.453,72	1759,00
	P105833	RC8-8, 24V, 6 mm kettingwiel 1/4" 65TDC	D	1.453,72	1759,00
	P105834	RC8-8, 12V, 6 mm kettingwiel 1/4" 65TDC Kaapstander	D	1.577,69	1909,00
	P105835	RC8-8, 24V, 6 mm kettingwiel 1/4" 65TDC Kaapstander	D	1.577,69	1909,00
	P105836	RC8-8, 12V, 6 mm kettingwiel 1/4" 165TDC	D	1.544,63	1869,00
	P105837	RC8-8, 24V, 6 mm kettingwiel 1/4" 165TDC	D	1.544,63	1869,00
	P105838	RC8-8, 12V, 6 mm kettingwiel 1/4" 165TDC Kaapstander	D	1.693,39	2049,00
	P105839	RC8-8, 24V, 6 mm kettingwiel 1/4" 165TDC Kaapstander	D	1.693,39	2049,00

RC10 VERTIKALE ANKERLIEREN VOOR TOUW/KETTING EN ALLEEN KETTING

RC10-8 geschikt voor 8 mm (5/16") ketting en 14-16 mm (9/16-5/8") Nylon lijn

338	P102571	RC10-8, 12V, 1000W 100TDC CW kettingwiel	D	1.577,69	1909,00
	P102572	RC10-8, 24V, 1000W 100TDC CW kettingwiel	D	1.577,69	1909,00
	P102596	RC10-8, hydraulisch, 100TDC CW kettingwiel	D	1.982,64	2399,00
	P102573	RC10-8, 12V, 1000W 100TDC CW kettingwiel + kaapstander	D	1.734,71	2099,00
	P102574	RC10-8, 24V, 1000W 100TDC CW kettingwiel + kaapstander	D	1.734,71	2099,00
	P102597	RC10-8, Hydraulisch, 100TDC CW kettingwiel + kaapstander	D	2.106,61	2549,00
	P105432	RC10-8 5/16" 150TDC 12V 1000W 56:1 StSt	D	1.693,39	2049,00
	P105433	RC10-8 5/16" 150TDC 24V 56:1 StSt	D	1.693,39	2049,00
	P105434	RC10-8 5/16" 150TDC HYD 56:1 StSt	D	2.065,29	2499,00
	P105435	RC10-8 5/16" CAP 150TDC 12V 1000W StSt	D	1.817,36	2199,00
	P105436	RC10-8 5/16" CAP 150TDC 24V 56:1 StSt	D	1.817,36	2199,00
	P105437	RC10-8 5/16" CAP 150TDC HYD 56:1 StSt	D	2.189,26	2649,00
	P105840	RC10-10-8 5/16" 100TDC 12V	D	1.817,36	2199,00
	P105842	RC10-10-8 5/16" 100TDC Capstan 12V	D	1.982,64	2399,00
	P105844	RC10-10-8 5/16" 150TDC 12V	D	1.941,32	2349,00
	P105846	RC10-10-8 5/16" 150TDC Capstan 12V	D	2.065,29	2499,00
	P104756	KIT- 48V Motor Upgrade 1200W	D	346,28	419,00

RC10-10 geschikt voor 10 mm (3/8") ketting en 16 mm (5/8") Nylon lijn

P102575	RC10-10, 12V, 1200W 100TDC CW kettingwiel	D	1.693,39	2049,00
P102576	RC10-10, 24V, 1200W 100TDC CW kettingwiel	D	1.693,39	2049,00
P102598	RC10-10, hydraulisch, 100TDC CW kettingwiel	D	2.230,58	2699,00
P102577	RC10-10, 12V, 1200W 100TDC CW kettingwiel + kaapstander	D	1.858,68	2249,00
P102578	RC10-10, 24V, 1200W 100TDC CW kettingwiel + kaapstander	D	1.858,68	2249,00
P102599	RC10-10, hydraulisch, 100TDC CW kettingwiel + kaapstander	D	2.065,29	2499,00
P105438	RC10-10 3/8" 150TDC 12V 56:1 StSt	D	2.023,97	2449,00
P105439	RC10-10 3/8" 150TDC 24V 56:1 StSt	D	2.023,97	2449,00
P105440	RC10-10, hydraulisch, 150TDC CW kettingwiel	D	2.354,55	2849,00
P105441	RC10-10, 12V, 1200W 150TDC CW kettingwiel + kaapstander	D	2.065,29	2499,00
P105442	RC10-10, 24V, 1200W 150TDC CW kettingwiel + kaapstander	D	2.065,29	2499,00
P105443	RC10-10 3/8" CAP 150TDC HYD 56:1 StSt	D	2.519,83	3049,00
P104756	KIT- 48V Motor Upgrade 1200W	D	346,28	419,00

RC12 VERTIKALE ANKERLIEREN VOOR TOUW/KETTING EN ALLEEN KETTING

RC12-10 geschikt voor 10 mm (3/8") ketting en 16-20 mm (5/8-3/4") Nylon lijn

340	P104900	RC12-10, 12V, 1200W 90TDC CW kettingwiel	D	4.379,34	5299,00
	P104901	RC12-10, 24V, 1200W 90TDC CW kettingwiel	D	4.379,34	5299,00
	P104902	RC12-10, hydraulisch, 90TDC CW kettingwiel	D	4.792,56	5799,00
	P104909	RC12-10, 12V, 1200W 90TDC CW kettingwiel + kaapstander	D	4.627,27	5599,00
	P104910	RC12-10, 24V, 1200W 90TDC CW kettingwiel + kaapstander	D	4.627,27	5599,00
	P104911	RC12-10, hydraulisch, 90TDC CW kettingwiel + kaapstander	D	5.040,50	6099,00
	P104936	RC12-10, 12V, 1200W 190TDC CW kettingwiel	D	4.544,63	5499,00
	P104937	RC12-10, 24V, 1200W 190TDC CW kettingwiel	D	4.544,63	5499,00
	P104938	RC12-10, hydraulisch, 190TDC CW kettingwiel	D	4.957,85	5999,00
	P104942	RC12-10, 12V, 1200W 190TDC CW kettingwiel + kaapstander	D	4.792,56	5799,00
	P104943	RC12-10, 24V, 1200W 190TDC CW kettingwiel + kaapstander	D	4.792,56	5799,00
	P104944	RC12-10, hydraulisch, 190TDC CW kettingwiel + kaapstander	D	5.205,79	6299,00
	P104918	RC12-10, 12V, 1200W 90TDC ACW kettingwiel	D	4.379,34	5299,00
	P104919	RC12-10, 24V, 1200W 90TDC ACW kettingwiel	D	4.379,34	5299,00
	P104920	RC12-10, hydraulisch, 90TDC ACW kettingwiel	D	4.792,56	5799,00
	P104927	RC12-10, 12V, 1200W 90TDC ACW kettingwiel + kaapstander	D	4.627,27	5599,00
	P104928	RC12-10, 24V, 1200W 90TDC ACW kettingwiel + kaapstander	D	4.627,27	5599,00
	P104929	RC12-10, hydraulisch, 90TDC ACW kettingwiel + kaapstander	D	5.040,50	6099,00
	P104948	RC12-10, 12V, 1200W 190TDC ACW kettingwiel + kaapstander	D	4.792,56	5799,00
	P104949	RC12-10, 24V, 1200W 190TDC ACW kettingwiel + kaapstander	D	4.792,56	5799,00
	P104950	RC12-10, 24V, 1200W 190TDC CW kettingwiel + kaapstander	D	5.205,79	6299,00
	P104756	KIT- 48V Motor Upgrade 1200W	D	346,28	419,00

RC12-12 geschikt voor 12-13 mm (1/2") ketting en 20 mm (3/4") Nylon lijn

	P104906	RC12-11, 12V, 1200W 90TDC CW kettingwiel	D	4.379,34	5299,00
	P104907	RC12-11, 24V, 1200W 90TDC CW kettingwiel	D	4.379,34	5299,00
	P104908	RC12-11, hydraulisch, 90TDC CW kettingwiel	D	4.792,56	5799,00
	P104915	RC12-11, 12V, 1200W 90TDC CW kettingwiel + kaapstander	D	4.627,27	5599,00
	P104916	RC12-11, 24V, 1200W 90TDC CW kettingwiel + kaapstander	D	4.627,27	5599,00
	P104917	RC12-11, hydraulisch, 90TDC CW kettingwiel + kaapstander	D	5.040,50	6099,00
	P104956	RC12-11, 12V, 1200W 190TDC CW kettingwiel	D	4.544,63	5499,00
	P104957	RC12-11, 24V, 1200W 190TDC CW kettingwiel	D	4.544,63	5499,00
	P104958	RC12-11, hydraulisch, 190TDC CW kettingwiel	D	4.957,85	5999,00
	P104959	RC12-11, 12V, 1200W 190TDC CW kettingwiel + kaapstander	D	4.792,56	5799,00
	P104960	RC12-11, 24V, 1200W 190TDC CW kettingwiel + kaapstander	D	4.792,56	5799,00
	P104961	RC12-11, hydraulisch, 190TDC CW kettingwiel + kaapstander	D	5.205,79	6299,00
	P104924	RC12-11, 12V, 1200W 90TDC ACW kettingwiel	D	4.379,34	5299,00
	P104925	RC12-11, 24V, 1200W 90TDC ACW kettingwiel	D	4.379,34	5299,00
	P104926	RC12-11, hydraulisch, 90TDC ACW kettingwiel	D	4.792,56	5799,00
	P104933	RC12-11, 12V, 1200W 90TDC ACW kettingwiel + kaapstander	D	4.627,27	5599,00
	P104934	RC12-11, 24V, 1200W 90TDC ACW kettingwiel + kaapstander	D	4.627,27	5599,00
	P104935	RC12-11, hydraulisch, 90TDC ACW kettingwiel + kaapstander	D	5.040,50	6099,00
	P104962	RC12-11, 12V, 1200W 190TDC ACW kettingwiel	D	4.544,63	5499,00
	P104963	RC12-11, 24V, 1200W 190TDC ACW kettingwiel	D	4.544,63	5499,00
	P104964	RC12-11, hydraulisch, 190TDC ACW kettingwiel	D	4.957,85	5999,00
	P104965	RC12-11, 12V, 1200W 190TDC ACW kettingwiel + kaapstander	D	4.792,56	5799,00
	P104966	RC12-11, 24V, 1200W 190TDC ACW kettingwiel + kaapstander	D	4.792,56	5799,00
	P104967	RC12-11, hydraulisch, 190TDC ACW kettingwiel + kaapstander	D	5.205,79	6299,00
	P104756	KIT- 48V Motor Upgrade 1200W	D	346,28	419,00





		RC12-12 geschikt voor 12-13 mm (1/2") ketting en 20 mm (3/4") Nylon lijn			
	P104903	RC12-12, 12V, 1200W 90TDC CW kettingwiel	D	4.379,34	5299,00
	P104904	RC12-12, 24V, 1200W 90TDC CW kettingwiel	D	4.379,34	5299,00
	P104905	RC12-12, hydraulisch, 90TDC CW kettingwiel	D	4.792,56	5799,00
	P104912	RC12-12, 12V, 1200W 90TDC CW kettingwiel + kaapstander	D	4.627,27	5599,00
	P104913	RC12-12, 24V, 1200W 90TDC CW kettingwiel + kaapstander	D	4.627,27	5599,00
	P104914	RC12-12, hydraulisch, 90TDC CW kettingwiel + kaapstander	D	5.040,50	6099,00
	P104939	RC12-12, 12V, 1200W 190TDC CW kettingwiel	D	4.544,63	5499,00
	P104940	RC12-12, 24V, 1200W 190TDC CW kettingwiel	D	4.544,63	5499,00
	P104941	RC12-12, hydraulisch, 190TDC CW kettingwiel	D	4.957,85	5999,00
	P104945	RC12-12, 12V, 1200W 190TDC CW kettingwiel + kaapstander	D	4.792,56	5799,00
	P104946	RC12-12, 24V, 1200W 190TDC CW kettingwiel + kaapstander	D	4.792,56	5799,00
	P104947	RC12-12, hydraulisch, 190TDC CW kettingwiel + kaapstander	D	5.205,79	6299,00
	P104921	RC12-12, 12V, 1200W 90TDC ACW kettingwiel	D	4.379,34	5299,00
	P104922	RC12-12, 24V, 1200W 90TDC ACW kettingwiel	D	4.379,34	5299,00
	P104923	RC12-12, hydraulisch, 90TDC ACW kettingwiel	D	4.792,56	5799,00
	P104930	RC12-12, 12V, 1200W 90TDC ACW kettingwiel + kaapstander	D	4.627,27	5599,00
	P104931	RC12-12, 24V, 1200W 90TDC ACW kettingwiel + kaapstander	D	4.627,27	5599,00
	P104932	RC12-12, hydraulisch, 90TDC ACW kettingwiel + kaapstander	D	5.040,50	6099,00
	P104951	RC12-12, 12V, 1200W 190TDC ACW kettingwiel + kaapstander	D	4.792,56	5799,00
	P104952	RC12-12, 24V, 1200W 190TDC ACW kettingwiel + kaapstander	D	4.792,56	5799,00
	P104953	RC12-12, hydraulisch, 190TDC ACW kettingwiel + kaapstander	D	5.205,79	6299,00
	P104756	KIT- 48V Motor Upgrade 1200W	D	346,28	419,00
	P104652	RC12-12 13 mm DIN766 90TDC 12V CW	D	4.379,34	5299,00
	P104653	RC12-12 13 mm DIN766 90TDC 24V CW	D	4.379,34	5299,00
	P104654	RC12-12 13 mm DIN766 90TDC HYD CW	D	4.792,56	5799,00
	P104655	RC12-12 13 mm DIN766 90TDC 12V ACW	D	4.379,34	5299,00
	P104656	RC12-12 13 mm DIN766 90TDC 24V ACW	D	4.379,34	5299,00
	P104657	RC12-12 13 mm DIN766 90TDC HYD ACW	D	4.792,56	5799,00
	P104658	RC12-12 13 mm DIN766 Capstan 90TDC 12V CW	D	4.627,27	5599,00
	P104659	RC12-12 13 mm DIN766 Capstan 90TDC 24V CW	D	4.627,27	5599,00
	P104660	RC12-12 13 mm DIN766 Capstan 90TDC HYD CW	D	5.040,50	6099,00
	P104661	RC12-12 13 mm DIN766 Capstan 90TDC 12V ACW	D	4.627,27	5599,00
	P104662	RC12-12 13 mm DIN766 Capstan 90TDC 24V ACW	D	4.627,27	5599,00
	P104663	RC12-12 13 mm DIN766 Capstan 90TDC Hyd ACW	D	5.040,50	6099,00
	P104664	RC12-12 13 mm DIN766 190TDC 12V CW	D	4.544,63	5499,00
	P104665	RC12-12 13 mm DIN766 190TDC 24V CW	D	4.544,63	5499,00
	P104666	RC12-12 13 mm DIN766 190TDC HYD CW	D	4.957,85	5999,00
	P104667	RC12-12 13 mm DIN766 190TDC 12V ACW	D	4.544,63	5499,00
	P104668	RC12-12 13 mm DIN766 190TDC 24V ACW	D	4.544,63	5499,00
	P104669	RC12-12 13 mm DIN766 190TDC HYD ACW	D	4.957,85	5999,00
	P104670	RC12-12 13 mm DIN766 Capstan 190TDC 12V CW	D	4.792,56	5799,00
	P104671	RC12-12 13 mm DIN766 Capstan 190TDC 24V CW	D	4.792,56	5799,00
	P104672	RC12-12 13 mm DIN766 Capstan 190TDC HYD CW	D	5.205,79	6299,00
	P104673	RC12-12 13 mm DIN766 Capstan 190TDC 12V ACW	D	4.792,56	5799,00
	P104674	RC12-12 13 mm DIN766 Capstan 190TDC 24V ACW	D	4.792,56	5799,00
	P104675	RC12-12 13 mm DIN766 Capstan 190TDC HYD ACW	D	5.205,79	6299,00
	P104756	KIT- 48V Motor Upgrade 1200W	D	346,28	419,00
		RC12HD geschikt voor 10 mm (3/8") ketting en 16-20 mm (5/8-3/4") nylon lijn			
342	P105400	RC12-HD, 10 mm 24V, 2000W 100TDC CW kettingwiel + kaapstander	D	6.321,49	7649,00
	P105401	RC12-HD, 10 mm 24V, 2000W 100TDC ACW kettingwiel + kaapstander	D	6.321,49	7649,00
	P105402	RC12-HD, 10 mm 24V, 2000W 100TDC CW kettingwiel	D	6.032,23	7299,00
	P105403	RC12-HD, 10 mm 24V, 2000W 100TDC ACW kettingwiel	D	6.032,23	7299,00
	P105404	RC12-HD, 10 mm 24V, 2000W 200TDC CW kettingwiel + kaapstander	D	6.445,45	7799,00
	P105405	RC12-HD, 10 mm 24V, 2000W 200TDC ACW kettingwiel + kaapstander	D	6.445,45	7799,00
	P105406	RC12-HD, 10 mm 24V, 2000W 200TDC CW kettingwiel	D	6.197,52	7499,00
	P105407	RC12-HD, 10 mm 24V, 2000W 200TDC ACW kettingwiel	D	6.197,52	7499,00
		RC12HD geschikt voor 11 mm (3/8" ISO) ketting en 16-20 mm (5/8-3/4") nylon lijn			
	P105416	RC12-HD, 11 mm 24V, 2000W 100TDC CW kettingwiel + kaapstander	D	6.321,49	7649,00
	P105417	RC12-HD, 11 mm 24V, 2000W 100TDC ACW kettingwiel + kaapstander	D	6.321,49	7649,00
	P105418	RC12-HD, 11 mm 24V, 2000W 100TDC CW kettingwiel	D	6.032,23	7299,00
	P105419	RC12-HD, 11 mm 24V, 2000W 100TDC ACW kettingwiel	D	6.032,23	7299,00
	P105420	RC12-HD, 11 mm 24V, 2000W 200TDC CW kettingwiel + kaapstander	D	6.445,45	7799,00
	P105421	RC12-HD, 11 mm 24V, 2000W 200TDC ACW kettingwiel + kaapstander	D	6.445,45	7799,00

P105422	RC12-HD, 11 mm 24V, 2000W 200TDC CW kettingwiel	D	6.197,52	7499,00	
P105423	RC12-HD, 11 mm 24V, 2000W 200TDC ACW kettingwiel	D	6.197,52	7499,00	

RC12-HD VERTIKALE ANKERLIEREN VOOR TOUW/KETTING EN ALLEEN KETTING

P104968	RC12-HD, 24, 2000 100TDC CW kettingwiel + kaapstander	D	6.321,49	7649,00	
P104969	RC12-HD, 24, 2000 100TDC ACW kettingwiel + kaapstander	D	6.321,49	7649,00	
P104970	RC12-HD, 24, 2000 100TDC CW kettingwiel	D	6.032,23	7299,00	
P104971	RC12-HD, 24, 2000 100TDC ACW kettingwiel	D	6.032,23	7299,00	
P104972	RC12-HD, 24, 2000 200TDC CW kettingwiel + kaapstander	D	6.445,45	7799,00	
P104973	RC12-HD, 24, 2000 200TDC ACW kettingwiel + kaapstander	D	6.445,45	7799,00	
P104974	RC12-HD, 24, 2000 200TDC CW kettingwiel	D	6.197,52	7499,00	
P104975	RC12-HD, 24, 2000 200TDC ACW kettingwiel	D	6.197,52	7499,00	

RC12-HD Hydraulisch

RC12HD geschikt voor 10 mm (3/8") ketting en 16-20 mm (5/8-3/4") nylon lijn

P105408	RC12-HD, 10 mm hydraulisch, 100TDC CW kettingwiel + kaapstander	D	6.073,55	7349,00	
P105409	RC12-HD, 10 mm hydraulisch, 100TDC ACW kettingwiel + kaapstander	D	6.073,55	7349,00	
P105410	RC12-HD, 10 mm hydraulisch, 100TDC CW kettingwiel	D	6.032,23	7299,00	
P105411	RC12-HD, 10 mm hydraulisch, 100TDC ACW kettingwiel	D	5.825,62	7049,00	
P105412	RC12-HD, 10 mm hydraulisch, 200TDC CW kettingwiel + kaapstander	D	6.238,84	7549,00	
P105413	RC12-HD, 10 mm hydraulisch, 200TDC ACW kettingwiel + kaapstander	D	6.238,84	7549,00	
P105414	RC12-HD, 10 mm hydraulisch, 200TDC CW kettingwiel	D	5.990,91	7249,00	
P105415	RC12-HD, 10 mm hydraulisch, 200TDC ACW kettingwiel	D	5.990,91	7249,00	

RC12HD geschikt voor 11 mm (3/8" ISO) ketting en 16-20 mm (5/8-3/4") nylon lijn

P105424	RC12-HD, 11 mm hydraulisch, 100TDC CW kettingwiel + kaapstander	D	6.073,55	7349,00	
P105425	RC12-HD, 11 mm hydraulisch, 100TDC ACW kettingwiel + kaapstander	D	6.073,55	7349,00	
P105426	RC12-HD, 11 mm hydraulisch, 100TDC CW kettingwiel	D	5.825,62	7049,00	
P105427	RC12-HD, 11 mm hydraulisch, 100TDC ACW kettingwiel	D	5.825,62	7049,00	
P105428	RC12-HD, 11 mm hydraulisch, 200TDC CW kettingwiel + kaapstander	D	6.238,84	7549,00	
P105429	RC12-HD, 11 mm hydraulisch, 200TDC ACW kettingwiel + kaapstander	D	6.238,84	7549,00	
P105430	RC12-HD, 11 mm LP hydraulisch, 200TDC CW 3/8"	D	5.990,91	7249,00	
P105431	RC12-HD, 11 mm LP hydraulisch, 200TDC ACW 3/8"	D	5.990,91	7249,00	



P104989	RC12-HD, Hyd, 100TDC CW kettingwiel + kaapstander	D	6.073,55	7349,00	
P104990	RC12-HD, Hyd, 100TDC ACW kettingwiel + kaapstander	D	6.073,55	7349,00	
P104991	RC12-HD, Hyd, 100TDC CW kettingwiel	D	5.825,62	7049,00	
P104992	RC12-HD, Hyd, 100TDC ACW kettingwiel	D	5.825,62	7049,00	
P104993	RC12-HD, Hyd, 200TDC CW kettingwiel + kaapstander	D	6.238,84	7549,00	
P104994	RC12-HD, Hyd, 200TDC ACW kettingwiel + kaapstander	D	6.238,84	7549,00	
P104995	RC12-HD, Hyd, 200TDC CW kettingwiel	D	5.990,91	7249,00	
P104996	RC12-HD, Hyd, 200TDC ACW kettingwiel	D	5.990,91	7249,00	

RC12HD geschikt voor 10 mm (3/8") ketting en 16-20 mm (5/8-3/4") nylon lijn

P105452	RC12-HD, 10 mm hydraulisch GT, 100TDC CW kettingwiel + kaapstander	D	6.858,68	8299,00	
P105453	RC12-HD, 10 mm hydraulisch GT, 100TDC ACW kettingwiel + kaapstander	D	6.858,68	8299,00	
P105454	RC12-HD, 10 mm hydraulisch GT, 100TDC CW kettingwiel	D	6.032,23	7299,00	
P105455	RC12-HD, 10 mm hydraulisch GT, 100TDC ACW kettingwiel	D	6.610,74	7999,00	
P105456	RC12-HD, 10 mm hydraulisch GT, 200TDC CW kettingwiel + kaapstander	D	6.982,64	8449,00	
P105457	RC12-HD, 10 mm hydraulisch GT, 200TDC ACW kettingwiel + kaapstander	D	6.982,64	8449,00	
P105458	RC12-HD, 10 mm hydraulisch GT, 200TDC CW kettingwiel	D	6.734,71	8149,00	
P105459	RC12-HD, 10 mm hydraulisch GT, 200TDC ACW kettingwiel	D	6.734,71	8149,00	

P105460	RC12-HD, 11 mm hydraulisch GT, 100TDC CW kettingwiel + kaapstander	D	6.858,68	8299,00	
P105461	RC12-HD, 11 mm hydraulisch GT, 100TDC ACW kettingwiel + kaapstander	D	6.858,68	8299,00	
P105462	RC12-HD, 11 mm hydraulisch GT, 100TDC CW kettingwiel	D	6.610,74	7999,00	
P105463	RC12-HD, 11 mm hydraulisch GT, 100TDC ACW kettingwiel	D	6.610,74	7999,00	
P105464	RC12-HD, 11 mm hydraulisch GT, 200TDC CW kettingwiel + kaapstander	D	6.982,64	8449,00	
P105465	RC12-HD, 11 mm hydraulisch GT, 200TDC ACW kettingwiel + kaapstander	D	6.982,64	8449,00	
P105466	RC12-HD, 11 mm hydraulisch GT, 200TDC CW kettingwiel	D	6.734,71	8149,00	
P105467	RC12-HD, 11 mm hydraulisch GT, 200TDC ACW kettingwiel	D	6.734,71	8149,00	

RC12HD 12 mm geschikt voor 12-13 mm (1/2") ketting en 20 mm (3/4") nylon lijn

P105468	RC12-HD, 12 mm hydraulisch GT, 100TDC CW kettingwiel + kaapstander	D	6.858,68	8299,00	
P105469	RC12-HD, 12 mm hydraulisch GT, 100TDC ACW kettingwiel + kaapstander	D	6.858,68	8299,00	
P105470	RC12-HD, 12 mm hydraulisch GT, 100TDC CW kettingwiel	D	6.610,74	7999,00	

	P105471	RC12-HD, 12 mm hydraulisch GT, 100TDC ACW kettingwiel	D	6.610,74	7999,00
	P105472	RC12-HD, 12 mm hydraulisch GT, 200TDC CW kettingwiel + kaapstander	D	6.982,64	8449,00
	P105473	RC12-HD, 12 mm hydraulisch GT, 200TDC ACW kettingwiel + kaapstander	D	6.982,64	8449,00
	P105474	RC12-HD, 12 mm hydraulisch GT, 200TDC CW kettingwiel	D	6.734,71	8149,00
	P105475	RC12-HD, 12 mm hydraulisch GT, 200TDC ACW kettingwiel	D	6.734,71	8149,00

RC12-HD 3PH AC Elektrisch

RC12HD geschikt voor 10 mm (3/8") ketting en 16-20 mm (5/8-3/4") nylon lijn

	P105476	RC12-HD, 10 mm 220/400V 50hz AC, 100TDC CW kettingwiel + kaapstander	D	6.445,45	7799,00
	P105477	RC12-HD, 10 mm 220/400V 50hz AC, 100TDC ACW kettingwiel + kaapstander	D	6.445,45	7799,00
	P105478	RC12-HD, 10 mm 220/400V 50hz AC, 100TDC CW kettingwiel	D	6.197,52	7499,00
	P105479	RC12-HD, 10 mm 220/400V 50hz AC, 100TDC ACW kettingwiel	D	6.197,52	7499,00
	P105480	RC12-HD, 10 mm 220/400V 50hz AC, 200TDC CW kettingwiel + kaapstander	D	6.610,74	7999,00
	P105481	RC12-HD, 10 mm 220/400V 50hz AC, 200TDC ACW kettingwiel + kaapstander	D	6.610,74	7999,00
	P105482	RC12-HD, 10 mm 220/400V 50hz AC, 200TDC CW kettingwiel	D	6.362,81	7699,00
	P105483	RC12-HD, 10 mm 220/400V 50hz AC, 200TDC ACW kettingwiel	D	6.362,81	7699,00

RC12HD geschikt voor 11 mm (3/8" ISO) ketting en 16-20 mm (5/8-3/4") nylon lijn

	P105484	RC12-HD, 11 mm 220/400V 50hz AC, 100TDC CW kettingwiel + kaapstander	D	6.445,45	7799,00
	P105485	RC12-HD, 11 mm 220/400V 50hz AC, 100TDC ACW kettingwiel + kaapstander	D	6.445,45	7799,00
	P105486	RC12-HD, 11 mm 220/400V 50hz AC, 100TDC CW kettingwiel	D	6.197,52	7499,00
	P105487	RC12-HD, 11 mm 220/400V 50hz AC, 100TDC ACW kettingwiel	D	6.197,52	7499,00
	P105488	RC12-HD, 11 mm 220/400V 50hz AC, 200TDC CW kettingwiel + kaapstander	D	6.610,74	7999,00
	P105489	RC12-HD, 11 mm 220/400V 50hz AC, 200TDC ACW kettingwiel + kaapstander	D	6.610,74	7999,00
	P105490	RC12-HD, 11 mm 220/400V 50hz AC, 200TDC CW kettingwiel	D	6.362,81	7699,00
	P105491	RC12-HD, 11 mm 220/400V 50hz AC, 200TDC ACW kettingwiel	D	6.362,81	7699,00

RC12HD 12 mm geschikt voor 12-13 mm (1/2") ketting en 20 mm (3/4") nylon lijn

	P105492	RC12-HD, 12 mm 220/400V 50hz AC, 100TDC CW kettingwiel + kaapstander	D	6.445,45	7799,00
	P105493	RC12-HD, 12 mm 220/400V 50hz AC, 100TDC ACW kettingwiel + kaapstander	D	6.445,45	7799,00
	P105494	RC12-HD, 12 mm 220/400V 50hz AC, 100TDC CW kettingwiel	D	6.197,52	7499,00
	P105495	RC12-HD, 12 mm 220/400V 50hz AC, 100TDC ACW kettingwiel	D	6.197,52	7499,00
	P105496	RC12-HD, 12 mm 220/400V 50hz AC, 200TDC CW kettingwiel + kaapstander	D	6.610,74	7999,00
	P105497	RC12-HD, 12 mm 220/400V 50hz AC, 200TDC ACW kettingwiel + kaapstander	D	6.610,74	7999,00
	P105498	RC12-HD, 12 mm 220/400V 50hz AC, 200TDC CW kettingwiel	D	6.362,81	7699,00
	P105499	RC12-HD, 12 mm 220/400V 50hz AC, 200TDC ACW kettingwiel	D	6.362,81	7699,00

ANCHORMAX VERTIKALE KAAPSTANDER VOOR LIJN

De prijs anchormax is incl. motor, gearbox en voetschakelaar zonder deksel

	344	P100461	Anchormax, 12V, 500W, Kaapstander, Maximum lijn Dia. 12 mm	D	742,98	899,00
		P102535	Anchormax, 24V, 500W, Kaapstander, Maximum lijn Dia. 12 mm	D	742,98	899,00

VERTIKALE KAAPSTANDER VOOR LIJN

Alle onderstaande kaapstanders worden geleverd incl. motor en overbrenging. elektrische accessoires dienen apart besteld te worden

500 VC voor 12 mm lijn

	345	P100455	500 VC 12V 50TDC, maximum lijn dia. 12 mm, 600W	D	1.172,73	1419,00
		P100456	500 VC 24V 50TDC, maximum lijn dia. 12 mm, 600W	D	1.172,73	1419,00

1000 VC voor 14 mm lijn

	P102787	1000 VC, 12V, 1000W, 100TDC kaapstander	D	1.511,57	1829,00
	P102788	1000 VC, 24V, 1000W, 100TDC kaapstander	D	1.511,57	1829,00
	P102789	1000 VC, hydraulisch, 100TDC kaapstander	D	1.776,03	2149,00
	P102784	1000 VC, 12V, 1000W, 50TDC kaapstander	D	1.561,16	1889,00
	P102785	1000 VC, 24V, 1000W, 50TDC kaapstander	D	1.561,16	1889,00
	P102786	1000 VC, hydraulisch, 50TDC kaapstander	D	1.817,36	2199,00
	P102790	1000 VC, 12V, 1000W, 150TDC kaapstander	D	1.561,16	1889,00
	P102791	1000 VC, 24V, 1000W, 150TDC kaapstander	D	1.561,16	1889,00
	P102792	1000 VC, hydraulisch, 150TDC kaapstander	D	1.817,36	2199,00

Note:

De lijn diameters zijn gebaseerd op een minimum van drie windingen rond de kaapstander. Op standaard SCW configuraties is het kettingwiel aan de stuurboordzijde gemonteerd.



VERTIKALE ANKERLIEREN VOOR LIJN EN KETTING COMBINATIE

Alle onderstaande ankerlieren worden geleverd incl. motor en overbrenging. elektrische accessoires dienen apart besteld te worden (zie pagina 318)

VW10-8 geschikt voor 8 mm (5/16") ketting en 14-16 mm (9/16-5/8") Nylon lijn

346	P102586	VW10-8, 12V, 1000W 100TDC kettingwiel + kaapstander	F	1.734,71	2099,00
	P102587	VW10-8, 24V, 1000W 100TDC kettingwiel + kaapstander	F	1.734,71	2099,00
	P102584	VW10-8, 12V, 1000W, 100TDC kettingwiel	F	1.552,89	1879,00
	P102585	VW10-8, 24V, 1000W, 100TDC kettingwiel	F	1.552,89	1879,00
	P105446	VW10-8, 12V, 1000W 150TDC kettingwiel + kaapstander	F	1.858,68	2249,00
	P105447	VW10-8, 24V, 1000W 150TDC kettingwiel + kaapstander	F	1.858,68	2249,00
	P105444	VW10-8, 12V, 1000W 150TDC kettingwiel	F	1.693,39	2049,00
	P105445	VW10-8, 24V, 1000W 150TDC kettingwiel	F	1.693,39	2049,00

VW10-10 geschikt voor 10 mm (3/8") ketting en 16 mm (5/8") Nylon lijn

	P102590	VW10-10, 12V, 1200W 100TDC kettingwiel + kaapstander	F	1.635,54	1979,00
	P102591	VW10-10, 24V, 1200W 100TDC kettingwiel + kaapstander	F	1.635,54	1979,00
	P102588	VW10-10, 12V, 1200W, 100TDC kettingwiel	F	1.734,71	2099,00
	P102589	VW10-10, 24V, 1200W, 100TDC kettingwiel	F	1.734,71	2099,00
	P105450	RC10-10, hydraulisch, 150TDC CW kettingwiel + kaapstander	F	1.941,32	2349,00
	P105451	VW10-10, 24V, 1200W 150TDC kettingwiel + kaapstander	F	1.982,64	2399,00
	P105448	VW10-10, 12V, 1200W 150TDC kettingwiel	F	1.776,03	2149,00
	P105449	VW10-10, 24V, 1200W 150TDC kettingwiel	F	1.776,03	2149,00
	P104756	KIT- 48V Motor Upgrade 1200W	D	346,28	419,00

VERTIKALE ANKERLIEREN VOOR TRADITIONELE BEDIENING VAN LIJN/KETTING EN ALLEEN KETTING

Alle onderstaande ankerlieren worden geleverd incl. motor en overbrenging. elektrische accessoires dienen apart besteld te worden (zie pagina 318)

500 VW geschikt voor 6 mm ketting (kettingwiel apart geselecteerd)

347	P100457	500 VW, 12V, 600W, 50TDC kettingwiel + kaapstander	F	1.536,36	1859,00
	P100458	500 VW, 24V, 600W, 50TDC kettingwiel + kaapstander	F	1.536,36	1859,00

1000 VW geschikt voor 6-8 mm ketting (kettingwiel apart geselecteerd)

	P102769	1000 VW, 12V, 1000W, 100TDC kettingwiel + kaapstander	F	2.437,19	2949,00
	P102770	1000 VW, 24V, 1000W, 100TDC kettingwiel + kaapstander	F	2.519,83	3049,00
	P102771	1000 VW, hydraulisch, 100TDC kettingwiel + kaapstander	F	2.891,74	3499,00
	P102766	1000 VW, 12V, 1000W, 50TDC kettingwiel + kaapstander	F	2.519,83	3049,00
	P102767	1000 VW, 24V, 1000W, 50TDC kettingwiel + kaapstander	F	2.519,83	3049,00
	P102768	1000 VW, hydraulisch, 50TDC kettingwiel + kaapstander	F	2.933,06	3549,00
	P102772	1000 VW, 12V, 1000W, 150TDC kettingwiel + kaapstander	F	2.519,83	3049,00
	P102773	1000 VW, 24V, 1000W, 150TDC kettingwiel + kaapstander	F	2.519,83	3049,00
	P102774	1000 VW, hydraulisch, 150TDC kettingwiel + kaapstander	F	2.933,06	3549,00
	P100438	1000 VWLP 100TDC 12V	F	2.354,55	2849,00
	P100439	1000 VWLP 100TDC 24V	F	2.354,55	2849,00
	P100440	1000 VWLP 100TDC Hyd	F	2.809,09	3399,00
	P100435	1000 VWLP 50TDC 12V	F	2.395,87	2899,00
	P100436	1000 VWLP 50TDC 24V	F	2.395,87	2899,00
	P100437	1000 VWLP 50TDC Hyd	F	2.809,09	3399,00
	P100441	1000 VWLP 150TDC 12V	F	2.395,87	2899,00
	P100442	1000 VWLP 150TDC 24V	F	2.395,87	2899,00
	P100443	1000 VWLP 150TDC Hyd	F	2.809,09	3399,00

1500 VW geschikt voor 6-10 mm ketting (kettingwiel apart geselecteerd)

	P102778	1500 VW 100TDC 12V 56:1	F	2.437,19	2949,00
	P102779	1500 VW 100TDC 24V	F	2.437,19	2949,00
	P102780	1500 VW 100TDC Hyd	F	2.933,06	3549,00
	P102775	1500 VW 50TDC 12V	F	2.478,51	2999,00
	P102776	1500 VW 50TDC 24V	F	2.478,51	2999,00
	P102777	1500 VW 50TDC Hyd	F	3.015,70	3649,00
	P102781	1500 VW 150TDC 12V	F	3.098,35	3749,00
	P102782	1500 VW 150TDC 24V	F	3.098,35	3749,00
	P102783	1500 VW 150TDC Hyd	F	3.015,70	3649,00
	P104756	KIT- 48V Motor Upgrade 1200W	D	346,28	419,00

1500 VWLP geschikt voor 6-10 mm ketting (kettingwiel apart geselecteerd)

	P100447	1500 VWLP, 12V, 1200W, 100TDC kettingwiel	F	2.189,26	2649,00
	P100448	1500 VWLP, 24V, 1200W, 100TDC kettingwiel	F	2.189,26	2649,00
	P100449	1500 VWLP, hydraulisch, 100TDC kettingwiel	F	2.891,74	3499,00





	P100444	1500 VWLP, 12V, 1200W, 50TDC kettingwiel	F	2.519,83	3049,00
	P100445	1500 VWLP, 24V, 1200W, 50TDC kettingwiel	F	2.519,83	3049,00
	P100446	1500 VWLP, hydraulisch, 50TDC kettingwiel	F	2.933,06	3549,00
	P100450	1000 VWLP, hydraulisch, 150TDC kettingwiel	F	2.519,83	3049,00
	P100451	1500 VWLP, 24V, 1200W, 150TDC kettingwiel	F	2.519,83	3049,00
	P100452	1500 VWLP, hydraulisch, 150TDC kettingwiel	F	2.933,06	3549,00
	P104756	KIT- 48V Motor Upgrade 1200W	D	346,28	419,00

2500 VW geschikt voor 9-11 mm ketting (kettingwiel apart geselecteerd)

	P105013	2500 VW, 12V, 1200W, 85TDC kettingwiel + kaapstander	F	4.131,40	4999,00
	P105014	2500 VW, 24V, 1200W, 85TDC kettingwiel + kaapstander	F	4.131,40	4999,00
	P105015	2500 VW, hydraulisch, 85TDC kettingwiel + kaapstander	F	4.585,95	5549,00
	P105016	2500 VW, 12V, 1200W, 185TDC kettingwiel + kaapstander	F	4.255,37	5149,00
	P105017	2500 VW, 24V, 1200W, 185TDC kettingwiel + kaapstander	F	4.255,37	5149,00
	P105018	2500 VW, hydraulisch, 185TDC kettingwiel + kaapstander	F	4.709,92	5699,00
	P104756	KIT- 48V Motor Upgrade 1200W	D	346,28	419,00

3500 VW geschikt voor 8-13 mm ketting (kettingwiel apart geselecteerd)

	P105882	3500 VW 12V DC 85TDC	F	5.577,69	6749,00
	P105881	3500 VW 24V DC 85TDC	F	5.577,69	6749,00
	P105883	3500 VW HYD 85TDC	F	6.073,55	7349,00
	P105884	3500 VWLP 24V DC 85TDC	F	5.577,69	6749,00
	P104756	KIT- 48V Motor Upgrade 1200W	D	346,28	419,00

	P16496	3500 VW, 12V, 1200W, 85TDC kettingwiel + kaapstander	F	4.503,31	5449,00
	P16497	3500 VW, 24V, 1200W, 85TDC kettingwiel + kaapstander	F	4.503,31	5449,00
	P16492	3500 VW, hydraulisch, 85TDC kettingwiel + kaapstander	F	4.751,24	5749,00

* Specificeer kettingwiel bij de bestelling. Ankerlierprijzen zijn incl. kettingwiel.

VERTIKALE ANKERLIEREN VOOR KETTING

Alle onderstaande ankerlieren worden geleverd incl. motor, overbrenging en relais. elektrische accessoires dienen apart besteld te worden (zie pagina 318)

1000 VWC geschikt voor 6-10 mm ketting (kettingwiel apart geselecteerd)

348		P102717	1000 VWC, 12V, 1000W, 100TDC CW kettingwiel + kaapstander	F	3.263,64	3949,00
		P102718	1000 VWC, 24V, 1000W, 100TDC CW kettingwiel + kaapstander	F	3.263,64	3949,00
		P102721	1000 VWC, hydraulisch, 100TDC CW kettingwiel + kaapstander	F	3.552,89	4299,00
		P102760	1000 VWC, 12V, 1000W, 50TDC CW kettingwiel + kaapstander	F	3.098,35	3749,00
		P102761	1000 VWC, 24V, 1000W, 50TDC CW kettingwiel + kaapstander	F	3.098,35	3749,00
		P102762	1000 VWC, hydraulisch, 50TDC CW kettingwiel + kaapstander	F	3.552,89	4299,00
		P102719	1000 VWC, 12V, 1000W, 150TDC CW kettingwiel + kaapstander	F	3.098,35	3749,00
		P102720	1000 VWC, 24V, 1000W, 150TDC CW kettingwiel + kaapstander	F	3.098,35	3749,00
		P102722	1000 VWC, hydraulisch, 150TDC CW kettingwiel + kaapstander	F	3.552,89	4299,00

1000 VWCLP geschikt voor 6-10 mm ketting (kettingwiel apart geselecteerd)

	P100420	1000 VWCLP, 12V, 1000W, 100TDC CW kettingwiel	F	3.222,31	3899,00
	P100421	1000 VWCLP, 24V, 1000W, 100TDC CW kettingwiel	F	3.222,31	3899,00
	P100422	1000 VWCLP, hydraulisch, 100TDC CW kettingwiel	F	3.552,89	4299,00
	P100417	1000 VWCLP, 12V, 1000W, 50TDC CW kettingwiel	F	3.180,99	3849,00
	P100418	1000 VWCLP, 24V, 1000W, 50TDC CW kettingwiel	F	3.180,99	3849,00
	P100419	1000 VWCLP, hydraulisch, 50TDC CW kettingwiel	F	3.594,21	4349,00
	P100423	1000 VWCLP, 12V, 1000W, 150TDC CW kettingwiel	F	3.180,99	3849,00
	P100424	1000 VWCLP, 24V, 1000W, 150TDC CW kettingwiel	F	3.180,99	3849,00
	P100425	1000 VWCLP, hydraulisch, 150TDC CW kettingwiel	F	3.552,89	4299,00

1500 VWC geschikt voor 6-10 mm ketting (kettingwiel apart geselecteerd)

	P102723	1500 VWC, 12V, 1200W, 100TDC CW kettingwiel + kaapstander	F	3.428,93	4149,00
	P102724	1500 VWC, 24V, 1200W, 100TDC CW kettingwiel + kaapstander	F	3.428,93	4149,00
	P102725	1500 VWC, hydraulisch, 100TDC CW kettingwiel + kaapstander	F	3.594,21	4349,00
	P102754	1500 VWC, 12V, 1200W, 50TDC CW kettingwiel + kaapstander	F	3.222,31	3899,00
	P102755	1500 VWC, 24V, 1200W, 50TDC CW kettingwiel + kaapstander	F	3.222,31	3899,00
	P102756	1500 VWC, hydraulisch, 50TDC CW kettingwiel + kaapstander	F	3.676,86	4449,00
	P102726	1500 VWC, 12V, 1200W, 150TDC CW kettingwiel + kaapstander	F	3.222,31	3899,00
	P102727	1500 VWC, 24V, 1200W, 150TDC CW kettingwiel + kaapstander	F	3.222,31	3899,00
	P102728	1500 VWC, hydraulisch, 150TDC CW kettingwiel + kaapstander	F	3.676,86	4449,00
	P104756	KIT- 48V Motor Upgrade 1200W	D	346,28	419,00

1500 VWCLP geschikt voor 6-10 mm ketting (kettingwiel apart geselecteerd)				
P100429	1500 VWCLP, 12V, 1200W, 100TDC CW kettingwiel	F	2.726,45	3299,00
P100430	1500 VWCLP 100TDC 24V CW 56:1	F	2.726,45	3299,00
P100431	1500 VWCLP, hydraulisch, 100TDC CW	F	5.288,43	6399,00
P100426	1500 VWCLP, 12V, 1200W, 50TDC CW kettingwiel	F	3.304,96	3999,00
P100427	1500 VWCLP, 24V, 1200W, 50TDC CW kettingwiel	F	3.304,96	3999,00
P100428	1500 VWCLP, hydraulisch, 50TDC CW kettingwiel	F	3.718,18	4499,00
P100432	1500 VWCLP 150TDC 12V CW	F	3.470,25	4199,00
P100433	1500 VWCLP 150TDC 24V CW	F	3.470,25	4199,00
P100434	1500 VWCLP 150TDC Hyd CW	F	3.718,18	4499,00
P104756	KIT- 48V Motor Upgrade 1200W	D	346,28	419,00
2500 VWC geschikt voor 9-11 mm ketting (kettingwiel apart geselecteerd)				
P105019	2500 VWC, 12V, 1200W, 85TDC CW kettingwiel + kaapstander	F	5.081,82	6149,00
P105020	2500 VWC, 24V, 1200W, 85TDC CW kettingwiel + kaapstander	F	5.081,82	6149,00
P105021	2500 VWC, hydraulisch, 85TDC CW kettingwiel + kaapstander	F	5.123,14	6199,00
P105022	2500 VWC, 12V, 1200W, 85TDC ACW kettingwiel + kaapstander	F	4.999,17	6049,00
P105023	2500 VWC, 24V, 1200W, 85TDC ACW kettingwiel + kaapstander	F	4.999,17	6049,00
P105024	2500 VWC, hydraulisch, 85TDC ACW kettingwiel + kaapstander	F	6.486,78	7849,00
P105025	2500 VWC, 12V, 1200W, 185TDC CW kettingwiel + kaapstander	F	5.701,65	6899,00
P105026	2500 VWC, 24V, 1200W, 185TDC CW kettingwiel + kaapstander	F	5.701,65	6899,00
P105027	2500 VWC, hydraulisch, 185TDC CW kettingwiel + kaapstander	F	5.536,36	6699,00
P104756	KIT- 48V Motor Upgrade 1200W	D	346,28	419,00
2500 VWCLP geschikt voor 9-11 mm ketting (kettingwiel apart geselecteerd)				
P105028	2500 VWCLP, 12V, 1200W, 85TDC CW kettingwiel	F	4.751,24	5749,00
P104646	2500 VWCLP 85TDC 12V ACW CR	F	4.751,24	5749,00
P105029	2500 VWCLP, 24V, 1200W, 85TDC CW kettingwiel	F	4.751,24	5749,00
P104647	2500 VWCLP 85TDC 24V ACW CR	F	4.751,24	5749,00
P105030	2500 VWCLP, hydraulisch, 85TDC CW kettingwiel	F	6.693,39	8099,00
P105031	2500 VWCLP, 12V, 1200W, 185TDC CW kettingwiel	F	4.627,27	5599,00
P105032	2500 VWCLP, 24V, 1200W, 185TDC CW kettingwiel	F	4.627,27	5599,00
P105033	2500 VWCLP, hydraulisch, 185TDC CW kettingwiel	F	5.123,14	6199,00
P104756	KIT- 48V Motor Upgrade 1200W	D	346,28	419,00
3500 VWC geschikt voor 8-13 mm ketting (kettingwiel apart geselecteerd)				
P105108	3500 VWC, 12V, 1200W, 100TDC CW kettingwiel + kaapstander	F	4.503,31	5449,00
P105111	3500 VWC, 24V, 1200W, 100TDC CW kettingwiel + kaapstander	F	4.503,31	5449,00
P105113	3500 VWC, hydraulisch, 100TDC CW kettingwiel + kaapstander	F	4.875,21	5899,00
P105109	3500 VWC, 12V, 1200W, 100TDC ACW kettingwiel + kaapstander	F	4.957,85	5999,00
P105112	3500 VWC, 24V, 1200W, 100TDC ACW kettingwiel + kaapstander	F	4.957,85	5999,00
P105114	3500 VWC, hydraulisch, 100TDC ACW kettingwiel + kaapstander	F	7.230,58	8749,00
P105115	3500 VWC, 12V, 1200W, 200TDC CW kettingwiel + kaapstander	F	5.040,50	6099,00
P105117	3500 VWC, 24V, 1200W, 200TDC CW kettingwiel + kaapstander	F	5.040,50	6099,00
P105119	3500 VWC, hydraulisch, 200TDC CW kettingwiel + kaapstander	F	5.701,65	6899,00
P105116	3500 VWC, 12V, 1200W, 200TDC ACW kettingwiel + kaapstander	F	4.999,17	6049,00
P105118	3500 VWC, 24V, 1200W, 200TDC ACW kettingwiel + kaapstander	F	4.999,17	6049,00
P105120	3500 VWC, hydraulisch, 200TDC ACW kettingwiel + kaapstander	F	5.453,72	6599,00
P104756	KIT- 48V Motor Upgrade 1200W	D	346,28	419,00
3500 VWCLP geschikt voor 8-13 mm ketting (kettingwiel apart geselecteerd)				
P105127	3500 VWCLP, 12V, 1200W, 100TDC CW kettingwiel	F	4.172,73	5049,00
P105129	3500 VWCLP, 24V, 1200W, 100TDC CW kettingwiel	F	4.172,73	5049,00
P105134	3500 VWCLP, hydraulisch, 100TDC CW kettingwiel	F	4.379,34	5299,00
P105128	3500 VWCLP, 12V, 1200W, 100TDC ACW kettingwiel	F	4.420,66	5349,00
P105130	3500 VWCLP, 24V, 1200W, 100TDC ACW kettingwiel	F	4.420,66	5349,00
P105135	3500 VWCLP, hydraulisch, 100TDC ACW kettingwiel	F	5.619,01	6799,00
P105136	3500 VWCLP, 12V, 1200W, 200TDC CW kettingwiel	F	4.916,53	5949,00
P105138	3500 VWCLP, 24V, 1200W, 200TDC CW kettingwiel	F	4.916,53	5949,00
P105140	3500 VWCLP, hydraulisch, 200TDC CW kettingwiel	F	5.619,01	6799,00
P105141	3500 VWCLP, hydraulisch, 200TDC ACW ST	F	4.833,88	5849,00
P104756	KIT- 48V Motor Upgrade 1200W	D	346,28	419,00
3500 VWC with Band Brake geschikt voor 8-13 mm ketting (kettingwiel apart geselecteerd)				
P105121	3500 VWC, 12V, 1200W, 100TDC CW Band Brake kettingwiel + kaapstander	F	3.966,12	4799,00
P105123	3500 VWC, 24V, 1200W, 100TDC CW Band Brake kettingwiel + kaapstander	F	3.966,12	4799,00
P105125	3500 VWC, hydraulisch, 100TDC CW Band Brake kettingwiel + kaapstander	F	6.445,45	7799,00



	P105122	3500 VWC, 12V, 1200W, 100TDC ACW Band Brake kettingwiel + kaapstander	F	5.990,91	7249,00
	P105124	3500 VWC, 24V, 1200W, 100TDC ACW Band Brake kettingwiel + kaapstander	F	5.990,91	7249,00
	P105126	3500 VWC, hydraulisch, 100TDC ACW Band Brake kettingwiel + kaapstander	F	5.495,04	6649,00
	P104756	KIT- 48V Motor Upgrade 1200W	D	346,28	419,00

* Specificeer kettingwiel bij de bestelling. Ankerlierprijzen zijn incl. kettingwiel.

TDC = total deck clearance / maximale dekdikte

CW = clockwise version, draairichting bij anker op is met de klok mee

ACW = anti clockwise version, draairichting bij anker op is tegen de klok in

HRC SERIE
HORIZONTALE AUTOMATISCHE TOUW/KETTING ANKERLIER

	P102820	HRCFF-6 12V, 400W, 6 mm ketting, 12 mm lijn	D	1.189,26	1439,00
	P102822	HRCFF-7 12V, 400W, 7 mm ketting, 12 mm lijn	D	1.189,26	1439,00
	P102825	HRCFF-8, 12V, 600W, 8 mm ketting, 14 mm lijn	D	1.288,43	1559,00
	P102826	HRCFF-8, 24V, 600W, 8 mm ketting, 14 mm lijn	D	1.288,43	1559,00

Horizontale automatische touw/ketting ankerlier

		HRC10-8 geschikt voor 8 mm (5/16") ketting and 14-16 mm (9/16-5/8") Nylon Rope			
352	P100240	HRC10-8, 12V, 1000W, SCW/SD(Port)	D	1.900,00	2299,00
	P100241	HRC10-8, 24V, 1000W, SCW/SD(Port)	D	1.900,00	2299,00
	P100244	HRC10-8, hydraulisch, SCW/SD(Port)	D	2.395,87	2899,00
	P100246	HRC10-8, 12V, 1000W, SCW	D	1.858,68	2249,00
	P100247	HRC10-8, 24V, 1000W, SCW	D	1.858,68	2249,00
	P100250	HRC10-8, hydraulisch, SCW	D	2.395,87	2899,00

HRC10-10 geschikt voor 10 mm (3/8") ketting and 16 mm (5/8") Nylon Rope



	P100242	HRC10-10, 12V, 1200W, SCW/SD(Port)	D	2.065,29	2499,00
	P100243	HRC10-10, 24V, 1200W, SCW/SD(Port) (10 mm -3/8")	D	2.065,29	2499,00
	P100245	HRC10-10, hydraulisch, SCW/SD(Port)	D	2.065,29	2499,00
	P100248	HRC10-10, 12V, 1200W, SCW	D	1.900,00	2299,00
	P100249	HRC10-10, 24V, 1200W, SCW	D	1.900,00	2299,00
	P100251	HRC10-10, hydraulisch, SCW	D	2.395,87	2899,00
	P104756	KIT- 48V Motor Upgrade 1200W	D	346,28	419,00

HWC SERIE
HORIZONTALE ANKERLIEREN VOOR REMOTE HANDLING VAN ALLEEN KETTING

Onderstaande ankerlieren zijn incl. motor en overbrenging. elektrische accessoires moeten apart worden bijbesteld.

		2500 HWC geschikt voor 9-11 mm ketting (kettingwiel apart geselecteerd)			
354	P105048	2500 HWC, 12V, 1200W, SCW/SD (bakboord)	F	6.445,45	7799,00
	P105049	2500 HWC, 24V, 1200W, SCW/SD (bakboord)	F	6.445,45	7799,00
	P105050	2500 HWC, hydraulisch, SCW/SD (bakboord)	F	6.528,10	7899,00
	P105045	2500 HWC, 12V, 1200W, SCW/SD (stuurboord)	F	6.114,88	7399,00
	P105046	2500 HWC, 24V, 1200W, SCW/SD (stuurboord)	F	6.114,88	7399,00
	P105047	2500 HWC, hydraulisch, SCW/SD (stuurboord)	F	6.528,10	7899,00
	P105037	2500 HWC, 12V, 1200W, DCW/SD (bakboord)	F	6.941,32	8399,00
	P105038	2500 HWC, 24V, 1200W, DCW/SD (bakboord)	F	6.941,32	8399,00
	P105039	2500 HWC, hydraulisch, DCW/SD (bakboord)	F	7.478,51	9049,00
	P105040	2500 HWC, 12V, 1200W, DCW/SD (stuurboord)	F	7.147,93	8649,00
	P105051	2500 HWC, 24V, 1200W, DCW/SD (stuurboord)	F	7.147,93	8649,00
	P105041	2500 HWC, hydraulisch, DCW/SD (stuurboord)	F	7.478,51	9049,00
	P105042	2500 HWC, 12V, 1200W, DCW	F	7.809,09	9449,00
	P105043	2500 HWC, 24V, 1200W, DCW	F	7.809,09	9449,00
	P105044	2500 HWC, hydraulisch, DCW	F	7.354,55	8899,00
	P105034	2500 HWC, 12V, 1200W, DCW/DD	F	8.098,35	9799,00
	P105035	2500 HWC, 24V, 1200W, DCW/DD	F	8.098,35	9799,00
	P105036	2500 HWC, hydraulisch, DCW/DD	F	8.511,57	10299,00
	P104756	KIT- 48V Motor Upgrade 1200W	D	346,28	419,00

3500 HWC geschikt voor 8-13 mm ketting (kettingwiel apart geselecteerd)

	P13093	3500 HWC, 12V, 1200W, SCW/SD (bakboord)	F	7.023,97	8499,00
	P13094	3500 HWC, 24V, 1200W, SCW/SD (bakboord)	F	7.023,97	8499,00
	P14292	3500 HWC, hydraulisch, SCW/SD (bakboord)	F	7.519,83	9099,00
	P14586	3500 HWC, hydraulisch, SCW/DD	F	7.230,58	8749,00
	P100217	3500 HWC, 12V, 1200W, DCW/SD (bakboord)	F	7.809,09	9449,00

P100224	3500 HWC, 24V, 1200W, DCW/SD (bakboord)	F	7.809,09	9449,00
P103036	3500 HWC, hydraulisch, DCW/SD (bakboord)	F	8.098,35	9799,00
P13089	3500 HWC, 12V, 1200W, DCW	F	8.015,70	9699,00
P13090	3500 HWC, 24V, 1200W, DCW	F	8.015,70	9699,00
P100218	3500 HWC, hydraulisch, DCW	F	7.313,22	8849,00
P13097	3500 HWC, 12V, 1200W, DCW/DD	F	7.850,41	9499,00
P13098	3500 HWC, 24V, 1200W, DCW/DD	F	7.850,41	9499,00
P14295	3500 HWC, hydraulisch, DCW/DD	F	8.057,02	9749,00
P104756	KIT- 48V Motor Upgrade 1200W	D	346,28	419,00

3500 HWVC geschikt voor 8-13 mm ketting (kettingwiel apart geselecteerd)

355	P13150	3500 HWVC, 12V, 1200W, SCW/SD VC	F	13.676,86	16549,00
	P13151	3500 HWVC, 24V, 1200W, SCW/SD VC	F	13.676,86	16549,00
	P13101	3500 HWVC, 12V, 1200W, DCW VC	F	14.585,95	17649,00
	P13102	3500 HWVC, 24V, 1200W, DCW VC	F	14.585,95	17649,00
	P14289	3500 HWVC, hydraulisch, DCW VC	F	15.453,72	18699,00
	P100229	3500 HWVC, 12V, 1200W, DCW/DD VC	F	14.999,17	18149,00
	P100230	3500 HWVC, 24V, 1200W, DCW/DD VC	F	14.999,17	18149,00
	P100223	3500 HWVC, hydraulisch, DCW/DD VC	F	15.825,62	19149,00
	P104756	KIT- 48V Motor Upgrade 1200W	D	346,28	419,00

Op standaard SCW configuraties is het kettingwiel aan de stuurboordzijde gemonteerd.

TASMAN SERIE

Tasman 6 & 8

356	P102872	TASMAN 8-8, 12V ,1000W incl. 100m 8 mm lijn & 10m 8 mm ketting	F	1.652,07	1999,00
	P102873	TASMAN 8-8, 24V ,1000W incl. 100m 8 mm lijn & 10m 8 mm ketting	F	1.652,07	1999,00
	P102874	TASMAN 8-6, 12V ,1000W incl. 150m 6 mm lijn & 10m 6 mm ketting	F	1.652,07	1999,00
	P102875	TASMAN 8-6, 24V ,1000W incl. 150m 6 mm lijn & 10m 6 mm ketting	F	1.652,07	1999,00
	P102876	TASMAN 6-6, 12V, 1000W incl. 70m 6 mm lijn & 10m 6 mm ketting	F	1.362,81	1649,00
	P102877	TASMAN 6-6, 24V, 1000W incl. 70m 6 mm lijn & 10m 6 mm ketting	F	1.362,81	1649,00
	P102878	TASMAN 6-4, 12V, 1000W incl. 100m 4 mm lijn, 10m 6 mm lijn & 10m 6 mm ketting	F	1.362,81	1649,00
	P102879	TASMAN 6-4, 24V, 1000W incl. 100m 4 mm lijn, 10m 6 mm lijn & 10m 6 mm ketting	F	1.362,81	1649,00
	P102883	TASMAN 8, 12 V, tro mm ellier	F	1.362,81	1649,00
	P102884	TASMAN 8, 24 V, tro mm ellier	F	1.362,81	1649,00

BEDIENINGSMATERIAAL

358	P102938	Op/neer afstandspaneel (12V/24V) tuimelschakelaar	F	29,71	35,95
	P102983	Op/neer afstandspaneel (12V/24V) drukknop type	F	177,69	215,00
	P104816	Afstandsbediening met twee knoppen	F	247,11	299,00
	P104817	Afstandsbediening met vier knoppen	F	362,81	439,00
	P19001	Voetschakelaar, roestvast stalen rand, geen klep, Ø 108 mm , 20 mm hoog, 49 mm diep	F	52,89	64,00
	P19006	Voetschakelaar, met zwarte klep, Ø 104 mm, 21 mm hoog, 47 mm diep	F	51,24	62,00
	P19007	Voetschakelaar, met witte klep, Ø 104 mm, 21 mm hoog, 47 mm diep	F	51,24	62,00
	P19008	Voetschakelaar, zwarte kunststof rand, geen klep, Ø 108 mm , 20 mm hoog, 49 mm diep	F	51,24	62,00
	P100735	Voetschakelaar, met roestvast stalen klep, Ø 118 mm, 24 mm hoog, 50 mm diep	F	101,65	123,00
	P104809	Compacte voetschakelaar met witte klep, 5 Amp, gebruik in combinatie met relais. Ø 65 mm, 22 mm hoog	F	56,20	68,00
	P104810	Compacte voetschakelaar met zwarte klep, 5 Amp, gebruik in combinatie met relais. Ø 65 mm, 22 mm hoog	F	56,20	68,00
		Het is raadzaam alle elektrische accessoires aan te sluiten op een spoel			
	P100715	Relais 12V (HRC6, HRC8, RC6 en RC8-6)	F	152,89	185,00
	P11121	Relais 24V (HRC6, HRC8, RC6 en RC8-6)	F	145,45	176,00
	P19045	Relais 12V (HRC10, RC8-8, RC10, RC12, 1000 - 3500 series)	F	147,93	179,00
	P19046	Relais 24V (HRC10, RC8-8, RC10, RC12, 1000 - 3500 series)	F	147,93	179,00
	SP5102	Relais 12V (HRC, RC6 en RC8-6)	F	155,37	188,00
	SP5103	Relais 24V (HRC, RC6 en RC8-6)	F	155,37	188,00
	SP5104	Relais 12V (RC8-8, RC10, RC12, 1000 - 3500 serie)	F	161,98	196,00
	SP5105	Relais 24V (RC8-8, RC10, RC12, 1000 - 3500 serie)	F	161,98	196,00
	SP5107	Relais 24V (RC12 HD 2kw DC)	F	156,20	189,00
	SP1393	Relais 12V (kaapstanders)	F	96,69	117,00
	SP1394	Relais 24V (kaapstanders)	F	96,69	117,00
	P100789	40 Amp 12V/24V accu zekering Isolator paneel	F	95,04	115,00
	P102902	50 Amp 12V/24V accu zekering Isolator paneel	F	95,04	115,00
	P102903	70 Amp 12V/24V accu zekering Isolator paneel	F	95,04	115,00



	P100790	80 Amp 12V/24V accu zekering Isolator paneel	F	95,04	115,00
	P100791	135 Amp 12V/24V accu zekering Isolator paneel	F	95,04	115,00



1500 RVC

	360	P100386	1500 RVC 12V DC	F	8.180,99	9899,00
		P100385	1500 RVC 24V DC	F	8.180,99	9899,00
		P100387	1500 RVC Hydraulisch	F	8.635,54	10449,00

2500 RVC Retractable

		P100364	2500 RVC 12V Retractable Kaapstaander	F	9.627,27	11649,00
		P100365	2500 RVC 24V Retractable Kaapstaander	F	9.627,27	11649,00
		P100366	2500 RVC Hyd Retractable Kaapstaander	F	10.040,50	12149,00

AUTOANCHOR KETTINGTELLERS

	361	P102939	AA150 ketting teller, zonder bediening	F	379,34	459,00
		P102944	AA560 Ketting teller en ankerlier bediening	F	734,71	889,00
		P102945	AA570 draadloze kettingteller, wandpaneel	F	990,91	1199,00
		P102981	AA710 draadloze ankerlier bediening set met kettingteller	F	1.073,55	1299,00
		P102994	AA730 ankerlier bediening met kettingteller (3,5mtr kabel)	F	875,21	1059,00

AUTOANCHOR, KABELS EN ACCESSOIRES

		P102909	AA sensor voor HRC ankerlieren	F	76,03	92,00
		SP4120	AA Sensor voor lijn/ketting tellers (bijgeleverd in standaard pakket)	P	46,28	56,00
		SP4156	6,5 mtr verlengkabel set voor kettingteller sensor	F	38,80	46,95
		SP5022	10 mtr verlengkabel set voor kettingteller sensor	F	53,72	65,00
		SP4157	15 mtr verlengkabel set voor kettingteller sensor	F	64,46	78,00
		SP4153	20 mtr verlengkabel set voor kettingteller sensor	F	73,55	89,00
		SP5017	35 mtr verlengkabel set voor kettingteller sensor	F	103,31	125,00
		SP4192	Verbindingstuk (om 2 verlengkabels aan elkaar te verbinden)	F	28,06	33,95
		SP4154	2 mtr verbindingkabel voor dubbele installatie	F	31,36	37,95
		SP4155	T-verbinding voor dubbele installatie	F	35,50	42,95
		P102946	AA570 Draadloos wandpaneel, alleen console unit	F	428,93	519,00
		P102977	AA710 extra draadloze bedienings unit	F	486,78	589,00
		P102982	AA710 base station	F	536,36	649,00
		P102980	AA710 antenne (aanbevolen voor staal / aluminum en composiet schepen)	F	428,93	519,00
		SP4143	Kabelset - 10 meter AA710 antenne EXT kabel 9406	F	230,58	279,00

LIER BEDIENINGEN VOOR TWEE RICHTINGEN EN LOSSE elektrische ACCESSOIRES



		P104862	AA730 Afstandbediening	F	445,45	539,00
		P102992	AA320 bedrade ankerlierbediening	F	133,06	161,00
		P102995	AA341 bedrade ankerlierbediening voor twee ankerlieren	F	238,84	289,00
		P102996	AA342 bedrade ankerlierbediening voor twee ankerlieren	F	238,84	289,00

BOEGROLLEN







	362	P105074	MAXSET boegrol zijdeglans voor MAXSET 4kg & 6kg ankers	F	165,29	200,00
		P105075	MAXSET boegrol gepolijst voor MAXSET 4kg & 6kg ankers	F	263,64	319,00
		P105076	MAXSET boegrol zijdeglans voor MAXSET 10kg ankers	F	222,31	269,00
		P105077	MAXSET boegrol gepolijst voor MAXSET 10kg ankers	F	214,05	259,00
		P105078	MAXSET boegrol zijdeglans voor MAXSET 16kg ankers	F	214,05	259,00
		P105079	MAXSET boegrol gepolijst voor MAXSET 16kg ankers	F	263,64	319,00
		P105080	MAXSET boegrol zijdeglans voor MAXSET 20kg ankers	F	304,96	369,00
		P105081	MAXSET boegrol gepolijst voor MAXSET 20kg ankers	F	362,81	439,00
		P105082	MAXSET boegrol zijdeglans voor MAXSET 25,30 & 40kg ankers	F	635,54	769,00
		P105083	MAXSET boegrol gepolijst voor MAXSET 25,30 & 40kg ankers	F	693,39	839,00
		P104340	Verlengbare boegrol	F	195,04	236,00
		P104345	Vaste boegrol met beugel	F	173,55	210,00
		P104330	Scharnierende boegrol type 1 voor max. 8 mm ketting	F	222,31	269,00
		P104331	Scharnierende boegrol type 2 voor max. 13 mm ketting	F	338,02	409,00
		P104332	Vaste boegrol type 1 voor max 8 mm ketting	F	66,94	81,00
		P104333	Vaste boegrol type 2 voor max 8 mm ketting	F	93,39	113,00
		P104334	Vaste boegrol type 3 voor max 13 mm ketting	F	195,87	237,00
		P105093	Boegroller 130 mm passend voor de TASMAN tro mm ellier	F	95,87	116,00
		P105094	Boegroller 180 mm passend voor 6-8 meter ketting	F	94,21	114,00

KETTINGSTOPPERS





363	P104372	Ketting stopper voor 8 mm ketting	F	144,63	175,00
	P104373	Ketting stopper voor 10 mm ketting	F	222,31	269,00

P104374	Ketting stopper voor 13 mm ketting	F	354,55	429,00	
P104335	Compacte kettingstopper voor 8-10 mm ketting	F	81,82	99,00	
P104358	Ketting stopper, hoogteverstelbaar voor 8 mm ketting	F	247,11	299,00	
P104359	Ketting stopper, hoogteverstelbaar voor 10 - 13 mm ketting	F	395,87	479,00	
P105257	Ketting stopper/ spanner voor 10 - 13 mm ketting	F	561,16	679,00	
P104740	Kettingstopper/spanner retrofit set 13 mm kettingstoppers	P	321,49	389,00	
P105072	Anchor Tensioner for 7 mm - 12 mm short link chain	F	123,14	149,00	

ANKERS





364	P105069	4kg / 9lb Maxset anker, gegalvaniseerd	F	41,32	50,00	
	P105000	6kg / 13lb Maxset anker, gegalvaniseerd	F	61,16	74,00	
	P105001	10kg / 22lb Maxset anker, gegalvaniseerd	F	97,52	118,00	
	P105002	16kg / 35lb Maxset anker, gegalvaniseerd	F	152,07	184,00	
	P105003	20kg / 44lb Maxset anker, gegalvaniseerd	F	179,34	217,00	
	P105004	25kg / 55lb Maxset anker, gegalvaniseerd	F	271,90	329,00	
	P105005	30kg / 66lb Maxset anker, gegalvaniseerd	F	304,96	369,00	
	P105006	40kg / 88lb Maxset anker, gegalvaniseerd	F	362,81	439,00	
	P105070	4 kg / 9 lb Maxset anker roestvast staal	F	163,64	198,00	
	P105055	6kg / 13lb Maxset anker, roestvast staal	F	222,31	269,00	
	P105056	10kg / 22lb Maxset anker, roestvast staal	F	379,34	459,00	
	P105057	16kg / 35lb Maxset anker, roestvast staal	F	610,74	739,00	
	P105058	20kg / 44lb Maxset anker, roestvast staal	F	767,77	929,00	
	P105059	25kg / 55lb Maxset anker, roestvast staal	F	982,64	1189,00	
	P105067	30kg / 66lb Maxset anker, roestvast staal	F	1.172,73	1419,00	
	P105068	40kg / 88lb Maxset anker, roestvast staal	F	1.561,16	1889,00	
	P105060	5kg / 10lb Maxclaw anker, roestvast staal	F	192,56	233,00	
	P105061	8kg / 18lb Maxclaw anker, roestvast staal	F	296,69	359,00	
	P105062	10kg / 22lb Maxclaw anker, roestvast staal	F	362,81	439,00	
	P105063	15kg / 33lb Maxclaw anker, roestvast staal	F	569,42	689,00	
	P105064	20kg / 44lb Maxclaw anker, roestvast staal	F	776,03	939,00	
	P105065	30kg / 66lb Maxclaw anker, roestvast staal	F	1.139,67	1379,00	
	P105066	40kg / 88lb Maxclaw anker, roestvast staal	F	1.495,04	1809,00	
	P101100	Verstelbare 'Devils Claw' voor 13 mm (1/2") ketting	F	1.619,01	1959,00	

WARTELS EN LIERHENDELS









365	P104370	Ketting wartel roestvast staal, voor 6 - 8 mm ketting	F	28,06	33,95	
	P104371	Ketting wartel roestvast staal, voor 10 - 13 mm ketting	F	41,28	49,95	
	SP4808	Ketting wartel roestvast staal, voor 12 - 14 mm ketting	F	329,75	399,00	
	P103864	Lierhendel voor noodbediening, 8", for RC8/RC10/RC12 Series ankerlieren	F	16,49	19,95	
	P103865	Lierhendel voor noodbediening, 10", for RC8/RC10/RC12 Series ankerlieren	P	16,49	19,95	
	7038	Noodbediening verleng as 150 mm	P	33,02	39,95	
	7369	Noodbediening adapter naar 1/2 aansluiting	P	9,05	10,95	
	SP3651	D-sluiting (RVS) - DEE - 6 mm	F	1,90	2,30	
	SP3653	D-sluiting (RVS) - DEE - 8 mm	F	2,81	3,40	
	SP3654	D-sluiting (RVS) - DEE - 10 mm	F	4,05	4,90	
	SP3655	D-sluiting (RVS) - DEE - 12 mm	F	7,81	9,45	
	SP4804	D-sluiting (RVS) - DEE - 14 mm	F	12,36	14,95	
	SP3656	Harp-sluiting (RVS) - BOW - 6 mm	F	2,07	2,50	
	SP3657	Harp-sluiting (RVS) - BOW - 8 mm	F	2,89	3,50	
	SP3658	Harp-sluiting (RVS) - BOW - 10 mm	F	4,09	4,95	
	SP3659	Harp-sluiting (RVS) - BOW - 12 mm	F	7,81	9,45	
	SP4805	Harp-sluiting (RVS) - BOW - 14 mm	F	13,18	15,95	



















KETTINGWIELEN

	3132/201C	Ketting wiel voor 500 series voor; 6 mm DIN766 ketting	F	395,87	479,00	
	3132/203C	Ketting wiel voor 500 series voor; 7 mm DIN766 ketting, 7 mm EN818, 1/4 G40 ISO	F	437,19	529,00	
	3173/118C	Ketting wiel voor 1000-1500 series voor; 6 mm DIN766 ketting	F	486,78	589,00	
	3173/110C	Ketting wiel voor 1000-1500 series voor; 1/4 BBB ketting	F	486,78	589,00	
	3173/111C	Ketting wiel voor 1000-1500 series voor; 1/4 G40 ISO, 7 mm EN818, 7 mm DIN766 ketting	F	528,10	639,00	
	3173/107C	Ketting wiel voor 1000-1500 series voor; 8 mm EN818, 8 mm DIN766 ketting	F	594,21	719,00	
	3173/105C	Ketting wiel voor 1000-1500 series voor; 5/16 BBB, 5/16 G40 ISO, 9 mm DIN766 ketting	F	577,69	699,00	
	3173/100C	Ketting wiel voor 1000-1500 series voor; 3/8 G40 ISO, 3/8 G30 ISO ketting	F	461,98	559,00	
	3173/114C	Ketting wiel voor 1000-1500 series voor; 3/8 BBB, 9 mm DIN766, 10 mm DIN766 ketting	F	569,42	689,00	

	3173/101C	Kettingwiel voor 1000-1500 series voor; 10 mm EN818 ketting	F	461,98	559,00
	3231/046C	Kettingwiel voor 2200-2500 series voor; 1/4 BBB, 1/4 G40 ISO, 9 mm DINN766 ketting	F	627,27	759,00
	3231/033C	Kettingwiel voor 2200-2500 series voor; 5/16 BBB, 5/16 G40 ISO, 9 mm DINN766 ketting	F	676,86	819,00
	3231/054C	Kettingwiel voor 2200-2500 series voor; 3/8 BBB, 10 mm DINN766 ketting	F	693,39	839,00
	3231/058C	Kettingwiel voor 2200-2500 series voor; 3/8 G30 ISO, 3/8 G40 ISO, BBB, 10 mm EN818 ketting	F	709,92	859,00
	3182/031C	Kettingwiel voor 3500-4000 series voor; 8 mm DIN766 ketting	F	792,56	959,00
	3182/033C	Kettingwiel voor 3500-4000 series voor; 5/16 BBB, 5/16 G40 ISO ketting	F	1.040,50	1259,00
	3182/054C	Kettingwiel voor 3500-4000 series voor; 3/8 BBB, 10 mm DIN766 ketting	F	957,85	1159,00
	3182/058C	Kettingwiel voor 3500-4000 series voor; 3/8 G30 ISO, 3/8 G40 ISO, 10 mm EN818 ketting	F	875,21	1059,00
	3182/043C	Kettingwiel voor 3500-4000 series voor; 13 mm DIN766, 12 mm EN818	F	891,74	1079,00
	3182/042C	Kettingwiel voor 3500-4000 series voor; 1/2 BBB ketting	F	974,38	1179,00
	3182/201C	Kettingwiel voor 3500-4000 series voor; 1/2 G40, 14 mm EN818 ketting	F	1.040,50	1259,00
	3182/016C	Kettingwiel voor 3500-4000 series voor; 1/2 ISO, 13 mm grade L ketting	F	900,00	1089,00
	5437/016C	Kettingwiel voor 13 mm PWB en 13 mm GR4 McKinnon ketting	P	1.139,67	1379,00
	5437/017C	Kettingwiel voor 12,5 mm tabend schakelketting (alleen VW-Serie)	P	1.139,67	1379,00
	5437/042C	Kettingwiel voor 1/2" BBB ACCO; 11.2 mm McKinnon; 7/16" C3,C4,C7 Campbell ketting	P	1.139,67	1379,00
	5437/043C	Kettingwiel voor 12 mm EN-818; 13 mm DIN 766; 7/16" G40 ACCO ketting	F	1.197,52	1449,00
	5437/044C	Kettingwiel voor 13 mm DIN 764 ketting	F	1.197,52	1449,00
	5437/054C	Kettingwiel voor 10 mm DIN 766; 3/8" BBB ACCO ketting	F	1.197,52	1449,00
	5437/058C	Kettingwiel voor 3/8" G30, G40, G63, G80 ACCO; 10 mm PWB; 10 mm EN-818; 10 mm P Serafini ketting	F	1.197,52	1449,00
	5437/201C	Kettingwiel voor 14 mm EN-818; 1/2" G40 ACCO NA cm ketting	F	1.197,52	1449,00





KETINGSTOPPERS, KETING en LIJN, SNUBBERS en WARELS



















	SP3651	D-sluiting (RVS) - DEE - 6 mm	F	1,90	2,30
	SP3653	D-sluiting (RVS) - DEE - 8 mm	F	2,81	3,40
	SP3654	D-sluiting (RVS) - DEE - 10 mm	F	4,05	4,90
	SP3655	D-sluiting (RVS) - DEE - 12 mm	F	7,81	9,45
	SP4804	D-sluiting (RVS) - DEE - 14 mm	F	12,36	14,95
	SP3656	Harp-sluiting (RVS) - BOW - 6 mm	F	2,07	2,50
	SP3657	Harp-sluiting (RVS) - BOW - 8 mm	F	2,89	3,50
	SP3658	Harp-sluiting (RVS) - BOW - 10 mm	F	4,09	4,95
	SP3659	Harp-sluiting (RVS) - BOW - 12 mm	F	7,81	9,45
	SP4805	Harp-sluiting (RVS) - BOW - 14 mm	F	13,18	15,95
	3132/201C	Kettingwiel voor 500 series voor; 6 mm DIN766 ketting	F	395,87	479,00
	3132/203C	Kettingwiel voor 500 series voor; 7 mm DIN766 ketting, 7 mm EN818, 1/4 G40 ISO	F	437,19	529,00
	3173/118C	Kettingwiel voor 1000-1500 series voor; 6 mm DIN766 ketting	F	486,78	589,00
	3173/110C	Kettingwiel voor 1000-1500 series voor; 1/4 BBB ketting	F	486,78	589,00
	3173/111C	Kettingwiel voor 1000-1500 series voor; 1/4 G40 ISO, 7 mm EN818, 7 mm DIN766 ketting	F	528,10	639,00
	3173/107C	Kettingwiel voor 1000-1500 series voor; 8 mm EN818, 8 mm DIN766 ketting	F	594,21	719,00
	3173/105C	Kettingwiel voor 1000-1500 series voor; 5/16 BBB, 5/16 G40 ISO, 9 mm DIN766 ketting	F	577,69	699,00
	3173/100C	Kettingwiel voor 1000-1500 series voor; 3/8 G40 ISO, 3/8 G30 ISO ketting	F	461,98	559,00
	3173/114C	Kettingwiel voor 1000-1500 series voor; 3/8 BBB, 9 mm DINN766, 10 mm DIN766 ketting	F	569,42	689,00
	3173/101C	Kettingwiel voor 1000-1500 series voor; 10 mm EN818 ketting	F	461,98	559,00
	3231/046C	Kettingwiel voor 2200-2500 series voor; 1/4 BBB, 1/4 G40 ISO, 9 mm DINN766 ketting	F	627,27	759,00
	3231/033C	Kettingwiel voor 2200-2500 series voor; 5/16 BBB, 5/16 G40 ISO, 9 mm DINN766 ketting	F	676,86	819,00
	3231/054C	Kettingwiel voor 2200-2500 series voor; 3/8 BBB, 10 mm DINN766 ketting	F	693,39	839,00
	3231/058C	Kettingwiel voor 2200-2500 series voor; 3/8 G30 ISO, 3/8 G40 ISO, BBB, 10 mm EN818 ketting	F	709,92	859,00
	3182/031C	Kettingwiel voor 3500-4000 series voor; 8 mm DIN766 ketting	F	792,56	959,00
	3182/033C	Kettingwiel voor 3500-4000 series voor; 5/16 BBB, 5/16 G40 ISO ketting	F	1.040,50	1259,00
	3182/054C	Kettingwiel voor 3500-4000 series voor; 3/8 BBB, 10 mm DIN766 ketting	F	957,85	1159,00
	3182/058C	Kettingwiel voor 3500-4000 series voor; 3/8 G30 ISO, 3/8 G40 ISO, 10 mm EN818 ketting	F	875,21	1059,00
	3182/043C	Kettingwiel voor 3500-4000 series voor; 13 mm DIN766, 12 mm EN818	F	891,74	1079,00
	3182/042C	Kettingwiel voor 3500-4000 series voor; 1/2 BBB ketting	F	974,38	1179,00
	3182/201C	Kettingwiel voor 3500-4000 series voor; 1/2 G40, 14 mm EN818 ketting	F	1.040,50	1259,00
	3182/016C	Kettingwiel voor 3500-4000 series voor; 1/2 ISO, 13 mm grade L ketting	F	900,00	1089,00
	5437/016C	Kettennuss für 13 mm PWB und 13 mm GR4 McKinnon Kette	P	1.139,67	1379,00
	5437/017C	Kettennuss für 12,5 mm Steggliederkette (nur VW-Serie)	P	1.139,67	1379,00
	5437/042C	Kettingwiel voor 1/2" BBB ACCO; 11.2 mm McKinnon; 7/16" C3,C4,C7 Campbell ketting	P	1.139,67	1379,00
	5437/043C	Kettingwiel voor 12 mm EN-818; 13 mm DIN 766; 7/16" G40 ACCO ketting	F	1.197,52	1449,00
	5437/044C	Kettingwiel voor 13 mm DIN 764 ketting	F	1.197,52	1449,00
	5437/054C	Kettingwiel voor 10 mm DIN 766; 3/8" BBB ACCO ketting	F	1.197,52	1449,00

	5437/058C	Kettingwiel voor 3/8" G30, G40, G63, G80 ACCO; 10 mm PWB; 10 mm EN-818; 10 mm P Serafini ketting	F	1.197,52	1449,00	
	5437/201C	Kettingwiel voor 14 mm EN-818; 1/2" G40 ACCO NA cm ketting	F		1.197,52	
366	SP3105	Ketting 6 mm, DIN766 thermisch verzinkt, prijs per meter	F	5,74	6,95	
	SP4050	Ketting 8 mm, DIN766 thermisch verzinkt, prijs per meter	F	10,70	12,95	
	SP4051	Ketting 10 mm DIN766 thermisch verzinkt, prijs per meter	F	18,14	21,95	
	SP4052	Ketting 13 mm DIN766 thermisch verzinkt, prijs per meter	F	24,75	29,95	
	SP4012	Ketting 10 mm EN818-3 thermisch verzinkt, prijs per meter	F	32,19	38,95	
	SP3666	Ketting 12 mm EN818-3 thermisch verzinkt, prijs per meter	F	68,60	83,00	
	SP4471	6 mm ketting, RVS, DINN766, prijs per meter	F	15,66	18,95	
	SP4207	8 mm ketting, RVS, DINN766, prijs per meter	F	28,88	34,95	
	SP2514	10 mm ketting, RVS, DINN766, prijs per meter	F	37,98	45,95	
	SP4474	13 mm ketting, RVS, DINN766, prijs per meter	F	59,50	72,00	
	SP4809	12 mm ketting, RVS, DINN766, prijs per 100 meter	F		4.461,98	
	SP4460	6 mm ketting, gegalvaniseerd, DINN766, 30mtr	F	140,50	170,00	
	SP4461	6 mm ketting, gegalvaniseerd, DINN766, 50mtr	F	247,11	299,00	
	SP4459	6 mm ketting, gegalvaniseerd, DINN766, 100mtr	F	470,25	569,00	
	SP4463	8 mm ketting, gegalvaniseerd, DINN766, 30mtr	F	238,84	289,00	
	SP4464	8 mm ketting, gegalvaniseerd, DINN766, 50mtr	F	362,81	439,00	
	SP4462	8 mm ketting, gegalvaniseerd, DINN766, 100mtr	F	767,77	929,00	
	SP4466	10 mm ketting, gegalvaniseerd, DINN766, 30mtr	F	395,87	479,00	
	SP4467	10 mm ketting, gegalvaniseerd, DINN766, 50mtr	F	676,86	819,00	
	SP4465	10 mm ketting, gegalvaniseerd, DINN766, 100mtr	F	1.230,58	1489,00	
	SP4469	13 mm ketting, gegalvaniseerd, DINN766, 30mtr	F	602,48	729,00	
	SP4470	13 mm ketting, gegalvaniseerd, DINN766, 50mtr	F	957,85	1159,00	
	SP4468	13 mm ketting, gegalvaniseerd, DINN766, 100mtr	F	2.147,93	2599,00	
	SP4603	10mtr, 6 mm ketting met 25mtr 12 mm 8 strengs ankerlijn	F	145,45	176,00	
	SP4603	10mtr, 6 mm ketting met 25mtr 12 mm 8 strengs ankerlijn	F	145,45	176,00	
367	SP2627	10mtr, 6 mm ketting met 50mtr 12 mm 8 strengs ankerlijn	F	271,90	329,00	
	SP2628	10mtr, 6 mm ketting met 100mtr 12 mm 8 strengs ankerlijn	F	461,98	559,00	
	SP2629	10mtr, 6 mm ketting met 150mtr 12 mm 8 strengs ankerlijn	F	652,07	789,00	
	SP2630	10mtr, 6 mm ketting met 200mtr 12 mm 8 strengs ankerlijn	F	825,62	999,00	
	SP2643	20mtr, 6 mm ketting met 100mtr 12 mm 8 strengs ankerlijn	F	511,57	619,00	
	SP2647	10mtr, 7 mm HDG ketting met 100mtr 12 mm 8 strengs ankerlijn	F	561,16	679,00	
	SP2631	10mtr, 8 mm ketting met 50mtr 14 mm 8 strengs ankerlijn	F	362,81	439,00	
	SP2632	10mtr, 8 mm ketting met 100mtr 14 mm 8 strengs ankerlijn	F	619,01	749,00	
	SP2633	10mtr, 8 mm ketting met 150mtr 14 mm 8 strengs ankerlijn	F	858,68	1039,00	
	SP2634	10mtr, 8 mm ketting met 100mtr 14 mm 8 strengs ankerlijn	F	1.114,88	1349,00	
	SP2644	20mtr, 8 mm ketting met 50mtr 14 mm 8 strengs ankerlijn	F	453,72	549,00	
	SP2642	20mtr, 8 mm ketting met 100mtr 14 mm 8 strengs ankerlijn	F	693,39	839,00	
	SP2648	10mtr, 10 mm ketting met 50mtr 16 mm 8 strengs ankerlijn	F	478,51	579,00	
	SP2649	10mtr, 10 mm ketting met 100mtr 16 mm 8 strengs ankerlijn	F	784,30	949,00	
	SP2645	20mtr, 10 mm ketting met 50mtr 16 mm 8 strengs ankerlijn	F	610,74	739,00	
	SP2646	20mtr, 10 mm ketting met 100mtr 16 mm 8 strengs ankerlijn	F	916,53	1109,00	
	SP3167	Lijn-Nylon 8 strengs 12 mm	F	4,92	5,95	
	SP3168	Lijn-Nylon 8 strengs 14 mm	F	8,22	9,95	
	SP3169	Lijn-Nylon 8 strengs 16 mm	F	15,66	18,95	
	SP4492	Lijn-Nylon 8 strengs 18 mm	F	21,45	25,95	
	SP3170	Lijn-Nylon 8 strengs 20 mm	F	21,45	25,95	
	SP3174	Ketting snubber voor 6-7 mm ketting	F	58,68	71,00	
	SP3175	Ketting snubber voor 8 mm ketting	F	66,12	80,00	
	SP3176	Ketting snubber voor 10 mm ketting	F	90,91	110,00	
	SP4211	Ketting snubber voor 13 mm ketting	F	166,94	202,00	
	P105072	Anchor Tensioner for 7 mm - 12 mm short link chain	F	123,14	149,00	







V _QUIPMENT

STUURSTOELEN













375	CHCOMW	CO mm ANDER luxe stuurstoel, FLIP-UP, wit onderhoudsvrij kunstleer	Q	519,83	629,00	
	CHCOMB	CO mm ANDER luxe stuurstoel, FLIP-UP, blauw onderhoudsvrij kunstleer	Q	519,83	629,00	
Nieuw!	CHCOMCB	CO mm ANDER luxe stuurstoel, FLIP-UP, cognac bruin onderhoudsvrij kunstleer	Q	519,83	629,00	
	CHCOMU	CO mm ANDER Stuurstoel, Niet gestoffeerd	Q	461,98	559,00	
	CHFUS	QUEEN Stuurstoel FLIP-UP, wit onderhoudsvrij kunstleer	Q	428,93	519,00	

		CHFUSBL QUEEN Stuurstoel FLIP-UP, blauw onderhoudsvrij kunstleer	Q	428,93	519,00
		CHFUSQU QUEEN Stuurstoel, Niet gestoffeerd	Q	371,07	449,00
		CHFUSW KING Stuurstoel FLIP-UP, wit onderhoudsvrij kunstleer met donkerblauwe bias	Q	395,87	479,00
		CHFUSB KING Stuurstoel FLIP-UP, donkerblauw onderhoudsvrij kunstleer + witte bias	Q	395,87	479,00
		CHFUSC KING Stuurstoel FLIP-UP, crème onderhoudsvrij kunstleer	Q	395,87	479,00
		CHFUSKU KING Stuurstoel, Niet gestoffeerd	Q	313,22	379,00
	376	CHFASW MASTER Stuurstoel RVS, wit onderhoudsvrij kunstleer + arMLEUNINGEN	Q	594,21	719,00
		CHFASB MASTER Stuurstoel RVS, donkerblauw onderhoudsvrij kunstleer + arMLEUNINGEN	Q	594,21	719,00
		CHFASC MASTER Stuurstoel RVS, crème onderhoudsvrij kunstleer + arMLEUNINGEN	Q	594,21	719,00
	Nieuw!	CHFASCB MASTER Stuurstoel RVS, cognac bruin onderhoudsvrij kunstleer + arMLEUNINGEN	Q	594,21	719,00
		CHFASU MASTER Stuurstoel, Niet gestoffeerd	Q	536,36	649,00
		CHSAILW2 SAILOR stuurstoel met geanodiseerd aluminium frame, wit onderhoudsvrij kunstleer	Q	404,13	489,00
		CHSAILB2 SAILOR stuurstoel met geanodiseerd aluminium frame, blauw onderhoudsvrij kunstleer	Q	404,13	489,00
		CHCASW SKIPPER Kapiteinsstoel, in wit onderhoudsvrij kunstleer	Q	362,81	439,00
		CHCASB SKIPPER Kapiteinsstoel, in blauw onderhoudsvrij kunstleer	Q	362,81	439,00
	377	CHLIEUTW LIEUTENANT Kapiteinsstoel, FLIP-UP, wit onderhoudsvrij kunstleer	Q	395,87	479,00
		CHLIEUTB LIEUTENANT Kapiteinsstoel, FLIP-UP, blauw onderhoudsvrij kunstleer	Q	395,87	479,00
		CHSPORTW PILOT, sportieve stuurstoel, FLIP-UP, wit onderhoudsvrij kunstleer	Q	362,81	439,00
		CHSPORTWB PILOT, sportieve stuurstoel, FLIP-UP, wit met zwart onderhoudsvrij kunstleer	Q	362,81	439,00
	Nieuw!	CHSPORTCB PILOT, sportieve stuurstoel, FLIP-UP, cognac bruin onderhoudsvrij kunstleer	Q	362,81	439,00
		CHSPORTTB PILOT, sportieve stuurstoel, FLIP-UP, carbonzwart onderhoudsvrij kunstleer met rood stiksel	Q	362,81	439,00
		CHSPORTU PILOT Stuurstoel, Niet gestoffeerd	Q	288,43	349,00
		CHDRIVEW DRIVER, sportieve stuurstoel, wit onderhoudsvrij kunstleer	Q	288,43	349,00
	Nieuw!	CHDRIVEWB DRIVER, sportieve stuurstoel, zwart en wit onderhoudsvrij kunstleer	Q	288,43	349,00
		CHDRIVECB DRIVER, sportieve stuurstoel, cognac bruin onderhoudsvrij kunstleer	Q	288,43	349,00
	378	CHADMW ADMIRAL, sportieve stuurstoel met lendesteun, FLIP-UP, wit onderhoudsvrij kunstleer	Q	404,13	489,00
		CHADMB ADMIRAL, sportieve stuurstoel met lendesteun, FLIP-UP, blauw onderhoudsvrij kunstleer	Q	404,13	489,00
		CHMAJORW MAJOR Kapiteinsstoel, FLIP-UP, wit onderhoudsvrij kunstleer	Q	486,78	589,00
		CHMAJOB MAJOR Kapiteinsstoel, FLIP-UP, blauw onderhoudsvrij kunstleer	Q	486,78	589,00
		CHSEAMMB SEAMAN Kapiteinsstoel, FLIP-UP, mahoniebruin	Q	610,74	739,00
		CHSEAMPW SEAMAN Kapiteinsstoel, FLIP-UP, puur wit	Q	610,74	739,00
	Nieuw!	CHSEAMC SEAMAN Kapiteinsstoel, FLIP-UP, licht ivoor	Q	610,74	739,00
		CHSEAMCB SEAMAN Kapiteinsstoel, FLIP-UP, cognac bruin	Q	610,74	739,00
	379	CAPTSEAT3 CAPTAIN basisstoel, wit (excl. kussenset)	Q	106,61	129,00
		CAPTCSL CAPTAIN kussenset, lichtgrijs	Q	78,51	95,00
		CAPTCSB CAPTAIN kussenset, donkerblauw	Q	78,51	95,00
		CHCS CREW Klapstoel zonder kussens	Q	57,02	69,00
		CHCW CREW Luxe lichtgewicht klapstoel met kunststof frame in wit vinyl	Q	102,48	124,00
		CHCBWB CREW Luxe lichtgewicht klapstoel met kunststof frame in blauw en wit vinyl	Q	102,48	124,00
		CHCG CREW Luxe lichtgewicht klapstoel met kunststof frame in grijs vinyl	Q	102,48	124,00
		CHFSWW FISCHERMAN Stuurstoel Classic, wit onderhoudsvrij kunstleer met donkerblauwe bias	Q	82,64	100,00
		CHFSBW FISCHERMAN Stuurstoel Classic, blauw onderhoudsvrij kunstleer met witte bias	Q	82,64	100,00
	380	CHPRIVEL PRIVATE visstoel, lichtgrijs	Q	54,55	66,00
		CHFSW FIRST MATE Stuurstoel, wit onderhoudsvrij kunstleer met donkerblauwe bias	Q	85,95	104,00
		CHFSB FIRST MATE Stuurstoel, donkerblauw onderhoudsvrij kunstleer met witte bias	Q	85,95	104,00
		CHFSL FIRST MATE Stuurstoel, licht grijs onderhoudsvrij kunstleer met donker grijze bias	Q	85,95	104,00
		CHFSD FIRST MATE Stuurstoel, donkergrijs onderhoudsvrij kunstleer met licht grijze bias	Q	85,95	104,00
		DCHFSW FIRST CLASS 2 persoons stoel, wit onderhoudsvrij kunstleer met donkerblauwe bias	Q	263,64	319,00
		DCHFSB FIRST CLASS 2 persoons stoel, donkerblauw met wit onderhoudsvrij kunstleer	Q	263,64	319,00
	381	CHTBSW Stuurstoel dubbel, wit onderhoudsvrij kunstleer met donkerblauwe bias	Q	185,12	224,00
		CHTBSB Stuurstoel dubbel, Donkerblauw onderhoudsvrij kunstleer met witte bias	Q	185,12	224,00
		DCHTBSW 2 pers. Stuurstoel, wit onderhoudsvrij kunstleer met donkerblauwe bias	Q	428,93	519,00
		DCHTBSB 2 pers. Stuurstoel, donkerblauw onderhoudsvrij kunstleer met witte bias	Q	428,93	519,00
		CCDS Beschermhoes voor stuurstoel (zilver)	Q	30,54	36,95
		CCSB Beschermhoes voor stuurstoel (blauw)	Q	30,54	36,95
		CCMS Beschermhoes voor stuurstoel (grijs)	Q	34,67	41,95
		CCMB Beschermhoes voor MASTER stuurstoel (blauw)	Q	34,67	41,95

INDIVIDUELE STOELBEKLEDING

382	CHSKAIB	Rol skai 'marine grade' kunstleer 5 x 1,37 meter in RAL 5013 Kobalt Blauw	Q	97,52	118,00	
	CHSKAIW	Rol skai 'marine grade' kunstleer 5 x 1,37 meter in RAL 9002 Grijs Wit	Q	97,52	118,00	
	CHSKAIC	Rol skai 'marine grade' kunstleer 5 x 1,37 meter in RAL 1015 Licht Ivoor	Q	97,52	118,00	
	CHSKAITG	Rol skai 'marine grade' kunstleer 5 x 1,37 meter in RAL7043 Diepgrijs	Q	97,52	118,00	
	CHSKAILG	Rol skai 'marine grade' kunstleer 5 x 1,37 meter in RAL 7004 Signaal Grijs	Q	97,52	118,00	
	CHSKAIPW	Rol skai 'marine grade' kunstleer 5 x 1,37 meter in RAL 9010 Puur Wit	Q	97,52	118,00	
	CHSKAIRR	Rol skai 'marine grade' kunstleer 5 x 1,37 meter in RAL 3003 Robijn Rood	Q	97,52	118,00	
	CHSKAIGB	Rol skai 'marine grade' kunstleer 5 x 1,37 meter in RAL 9011 Grafiet Zwart	Q	97,52	118,00	
	CHSKAIGY	Rol skai 'marine grade' kunstleer 5 x 1,37 meter in RAL 1004 Goud Geel	Q	97,52	118,00	
	CHSKAIEG	Rol skai 'marine grade' kunstleer 5 x 1,37 meter in RAL 6001 Smaragd Groen	Q	97,52	118,00	
	CHSKAIMB	Rol skai 'marine grade' kunstleer 5 x 1,37 meter in RAL 8016 Mahonie Bruin	Q	97,52	118,00	
	CHSKAISB	Rol skai 'marine grade' kunstleer 5 x 1,37 meter in RAL 5003 Saffier Blauw	Q	97,52	118,00	
	CHSKAISG	Rol skai 'marine grade' kunstleer 5 x 1,37 meter in RAL 7015 Leisteen Grijs	Q	97,52	118,00	
	CHSKAIAW	Rol skai 'marine grade' kunstleer 5 x 1,37 meter in RAL 9006 Aluminium Wit	Q	97,52	118,00	
	CHSKAITB	Rol skai 'marine grade' kunstleer 5 x 1,37 meter in RAL 9017 Diepzwart	Q	97,52	118,00	
Nieuw!	CHSKAICB	Rol skai 'marine grade' kunstleer 5 x 1,37 meter in RAL 8023 Oranjebruin (cognac)	Q	97,52	118,00	
	S.CHSKAI	Stalen set stoelkleuren	K	7,81	9,45	

STOELPOTEN

383	PCG3040	Verstelbare stoelpoot met gasveer en slede, hoogte 30 - 40 cm	Q	288,43	349,00	
	PCG3547	Verstelbare stoelpoot met gasveer en slede, hoogte 35 - 47 cm	Q	329,75	399,00	
	PCG4363	Verstelbare stoelpoot met gasveer en slede, hoogte 50 - 60,5 cm	Q	338,02	409,00	
	PCG5680	Verstelbare stoelpoot met gasveer en slede, hoogte 56 - 80 cm	Q	362,81	439,00	
	PCMS3040	Handmatig verstelbare stoelpoot met slede, hoogte 30 - 40 cm	Q	230,58	279,00	
	PCMS3547	Handmatig verstelbare stoelpoot met slede, hoogte 35 - 47 cm	Q	263,64	319,00	
	PCMS4363	Handmatig verstelbare stoelpoot met slede, hoogte 50,5 - 63,5 cm	Q	296,69	359,00	
	PCM3040	Handmatig verstelbare stoelpoot met swivel, hoogte 30 - 40 cm	Q	145,45	176,00	
	PCM3547	Handmatig verstelbare stoelpoot met swivel, hoogte 35 - 47 cm	Q	166,12	201,00	
	PCM4363	Handmatig verstelbare stoelpoot met swivel, hoogte 50,5 - 63,5 cm	Q	179,34	217,00	
	PCG5680	Verstelbare stoelpoot met gasveer en slede, hoogte 56 - 80 cm	Q	362,81	439,00	
384	PCFS33	Stoelpoot vaste hoogte, 33 cm, met slede	Q	139,67	169,00	
	PCF33	Stoelpoot vaste hoogte, 33 cm	Q	100,83	122,00	
	PCFS45	Stoelpoot vaste hoogte, 45 cm, met slede	Q	144,63	175,00	
	PCF45	Stoelpoot vaste hoogte, 45 cm	Q	106,61	129,00	
	FTREST73	Roteerbare voetsteun voor buis Ø73 mm	Q	190,08	230,00	
	FTREST87	Roteerbare voetsteun voor buis Ø87 mm	Q	185,12	224,00	
	PCBELL	Stoelpoot met bel vorm, handbediening / 33 tot 50 cm	Q	88,43	107,00	
	PC13	Stoelpoot met wartel / hoogte 13 cm	Q	90,91	110,00	
385	PCS15	Stoelpoot met slide / hoogte 15 cm	Q	125,62	152,00	
	PCBS	Stoelwartel met vergrendeling voor 7 posities en slide, 360° draaibaar, hoogte 7 cm, hendels links en rechts	Q	106,61	129,00	
	PCBSR	Stoelwartel met vergrendeling voor 7 posities en slide, 360° draaibaar, hoogte 7 cm, hendels rechts	Q	104,96	127,00	
	PCBL	Draaiplaat voor stoelmontage, met draaivergrendeling, hoogte 5 cm	Q	63,64	77,00	
	PCB	Verwijderbare draaiplaat voor stoelmontage, hoogte 5,5 cm	Q	30,54	36,95	
	PCBR	Draaiplaat voor stoelmontage, roestvast staal, hoogte 2,5 cm	Q	39,63	47,95	
386	SCU	Universele slide, hoogte 7 cm	Q	86,78	105,00	
	PCR38	Verwijderbare stoelpoot met bevestigingswartel, hoogte 38 cm	Q	114,05	138,00	
	PCRS38	Verwijderbare stoelpoot met bevestigingswartel en slide, hoogte 38 cm	Q	149,59	181,00	
	PCRQ33	Verwijderbare stoelpoot met "quick positioning" bevestigingswartel, hoogte 33 cm	Q	87,60	106,00	
	PCRQ38	Verwijderbare stoelpoot met "quick positioning" bevestigingswartel, hoogte 38 cm	Q	91,74	111,00	
	PCRBASE	Extra voetplaat voor verwijderbare stoelpoten type PCR	Q	45,45	55,00	

"QUICK POSITIONING SERIES" STOELPOTEN





387	PCQSWIV	"Quick positioning series" stoel montagewartel	Q	18,97	22,95	
	PCQF28C	"Quick positioning series" Alleen de poot, klik verbinding met de voetplaat, hoogte 28 cm	Q	23,10	27,95	
	PCQF28T	"Quick positioning series" Alleen de poot, schroefdraad verbinding met de voetplaat, hoogte 28 cm	Q	23,10	27,95	
	PCQF33C	"Quick positioning series" Alleen de poot, klik verbinding met de voetplaat, hoogte 33 cm	Q	25,58	30,95	
	PCQF33T	"Quick positioning series" Alleen de poot, schroefdraad verbinding met de voetplaat, hoogte 33 cm	Q	25,58	30,95	
	PCQF38C	"Quick positioning series" Alleen de poot, klik verbinding met de voetplaat, hoogte 38 cm	Q	26,40	31,95	
	PCQF38T	"Quick positioning series" Alleen de poot, schroefdraad verbinding met de voetplaat, hoogte 38 cm	Q	26,40	31,95	
	PCQG5774C	"Quick positioning series" Poot met gasveer en stoel montagewartel, klik, hoogte 57 - 74 cm	Q	100,83	122,00	
	PCQG5774T	"Quick positioning series" Poot met gasveer en stoel montagewartel, schroefdraad, hoogte 57 - 74 cm	Q	100,83	122,00	

	PCQBASEC	"Quick positioning series" Voetplaat, klik verbinding	Q	42,15	51,00
	PCQBASET	"Quick positioning series" Voetplaat, schroefdraad verbinding	Q	42,15	51,00



TAFELS

	388	PTT5070	Tafel incl. poot, ovaal (45 cm X 76 cm) handmatig verstelbaar 50 - 70 cm	Q	185,12	224,00
		TPM5070	Tafel incl. poot, handmatig verstelbaar van 50 - 70 cm	Q	185,12	224,00
		PTTF68	Tafel incl. poot, ovaal (45 cm X 76 cm) gefixeerd	Q	147,93	179,00
		PTF68	Tafel incl. poot, vaste hoogte 68 cm (flush)	Q	147,93	179,00
		PTTR68	Tafel incl. poot, demonteerbaar/ 68 cm	Q	147,93	179,00
		PTR68	Tafel incl. poot, vaste hoogte 68 cm	Q	147,93	179,00
	389	PCMS2969	3-staps tafelpoot, verstelbaar van 290 mm t/m 690 mm.	Q	164,46	199,00
		PT68	Tafelpoot met wartel / hoogte 685 mm	Q	98,35	119,00
		PS68	Tafelpoot verwijderbaar/ hoogte 685 mm	Q	98,35	119,00
		PTG3370M	Tafelpoot, gepolijst en geanodiseerd aluminium. Hoogteverstelling ondersteund door 230N gasveer	D	461,98	559,00
	390	TTR	Rond, Ø 600 mm	Q	80,17	97,00
		TTO	Ovaal, 450 mm x 760 mm	Q	74,38	90,00
		TBT	Tafelwartel geanodiseerd aluminium	Q	37,98	45,95
		TBTBA	Tafelwartel helder geanodiseerd aluminium	Q	40,45	48,95
		TCCA	Tafelpoot verzonken, geanodiseerd	Q	25,58	30,95
		TCCP	Tafelpoot verzonken, gepolijst	Q	45,45	55,00
		TCSA	Tafelpoot met schroefverbinding, geanodiseerd	Q	33,02	39,95
		TCSP	Tafelpoot met schroefverbinding, gepolijst en helder geanodiseerd	Q	52,89	64,00
		TCSPM	Tafelpoot met schroefverbinding, handmatig verstelbaar, gepolijst en helder geanodiseerd	Q	78,51	95,00
		TCSPG	Tafelpoot met schroefverbinding, pneumatisch verstelbaar, gepolijst en helder geanodiseerd	Q	121,49	147,00
		TBF	Geïntegreerde voetplaat	Q	33,02	39,95
		TBFBA	Aansluiting voor verzonken tafelpoot	Q	36,32	43,95
		TBR	Verwijderbare voetplaat	Q	36,32	43,95
		TBRBA	Aansluiting voor tafelpoot met schroefverbinding	Q	37,98	45,95

SCHEEPSHOORNS

	391	H12L	elektrische sloopshoorn, enkel, lage toon, 12V, roestvast staal	Q	59,50	72,00
		H12H	elektrische sloopshoorn, enkel, hoge toon, 12V, roestvast staal	Q	59,50	72,00
		H24L	elektrische sloopshoorn, enkel, lage toon, 24V, roestvast staal	Q	59,50	72,00
		H24H	elektrische sloopshoorn, enkel, hoge toon, 24V, roestvast staal	Q	59,50	72,00
		H12D	elektrische sloopshoorn, dubbel, 12V, roestvast staal	Q	116,53	141,00
		H24D	elektrische sloopshoorn, dubbel, 24V, roestvast staal	Q	116,53	141,00
		T12	elektrische inbouw hoorn, 12V. incl. witte, zwarte en verchromde afdek kap	Q	40,45	48,95
		TNA12L	Hoorn (enkel) 12 Volt, met lage toon, 420 Hz, 108 db	Q	37,15	44,95
		TNA12H	Hoorn (enkel) 12 Volt, met hoge toon, 480 Hz, 108 db	Q	37,15	44,95
		TNA24L	Hoorn (enkel) 24 Volt, met lage toon, 420 Hz, 108 db	Q	37,15	44,95
		TNA24H	Hoorn (enkel) 24 Volt, met hoge toon, 480 Hz, 108 db	Q	37,15	44,95
		TNA12D	Hoorn (dubbel) 12 Volt, met hoge en lage toon, 110 db	Q	71,90	87,00
		TNA24D	Hoorn (dubbel) 24 Volt, met hoge en lage toon, 110 db	Q	71,90	87,00
	392	C12L	elektrische sloopshoorn, enkel, lage toon, 12V, roestvast staal	Q	28,06	33,95
		C12D	elektrische sloopshoorn, dubbel, lage en hoge toon, 12V, roestvast staal	Q	55,37	67,00
		HORNPB	Drukknop-schakelaar voor sloopshoorn, max 15 A, 12/24 Volt	Q	30,54	36,95
		SLT3A	Telescopische roestvast stalen (AISI 316) zwemtrap met 3 treden, uitgetrokken lengte 880 mm	Q	97,52	118,00
		SLT4A	Telescopische roestvast stalen (AISI 316) zwemtrap met 4 treden, uitgetrokken lengte 1165 mm	Q	147,93	179,00
		SLT3AW	Telescopische roestvast stalen (AISI 316) zwemtrap (wijd) met 3 treden, uitgetrokken lengte 895 mm	Q	97,52	118,00
		SLT4AW	Telescopische roestvast stalen (AISI 316) zwemtrap (wijd) met 4 treden, uitgetrokken lengte 1160 mm	Q	150,41	182,00
	393	SLT3PA	Roestvast stalen (AISI 316) zwemtrap met 3 tredes, telescopische met zwart synthetische grips	Q	142,98	173,00
		SLT4PA	Roestvast stalen (AISI 316) zwemtrap met 4 tredes, telescopische met zwart synthetische grips	Q	195,04	236,00
		SLT4CA	Roestvast stalen (AISI 316) zwemtrap met 4 tredes, telescopische met inbouw cassette en zwart synthetische grips	Q	404,13	489,00
		SLFB3A	Opvouwbaar roestvast stalen (AISI 316) zwemtrap met bogen, 3 treden, uitgeklapte lengte 685 mm	Q	76,03	92,00
		SLFB4A	Opvouwbaar roestvast stalen (AISI 316) zwemtrap met bogen, 4 treden, uitgeklapte lengte 920 mm	Q	85,95	104,00
	394	SLT4DA	Roestvast stalen (AISI 316) zwemtrap met 4 tredes, telescopische met luxe uitgevoerde zwarte synthetische grips	Q	420,66	509,00
		SLF3A	Opvouwbaar roestvast stalen (AISI 316) zwemtrap met 3 treden, uitgeklapte lengte 625 mm	Q	69,42	84,00
		SLF4A	Opvouwbaar roestvast stalen (AISI 316) zwemtrap met 4 treden, uitgeklapte lengte 905 mm	Q	80,99	98,00
		SLFM3A	Opvouwbaar roestvast stalen (AISI 316) zwemtrap met 3 teak treden, uitgeklapte lengte 570 mm	Q	90,08	109,00
		SLFM4A	Opvouwbaar roestvast stalen (AISI 316) zwemtrap met 4 teak treden, uitgeklapte lengte 755 mm	Q	107,44	130,00







ROESTVAST STALEN HANDRELING (AISI 316)

395	PIJP	Roestvaststalen relingpijp Ø 20 mm (per meter)	Q	31,36	37,95	
	PIJP25	Roestvaststalen relingpijp Ø 25 mm (per meter)	Q	34,67	41,95	
	STEUN20V	Roestvast stalen voorstuk voor relingpijp Ø 20 mm	Q	13,18	15,95	
	STEUN20A	Roestvast stalen eindstuk voor relingpijp Ø 20 mm	Q	13,18	15,95	
	STEUN20M	Roestvast stalen middenstuk voor relingpijp Ø 20 mm	Q	13,18	15,95	
	STEUN25V	Roestvast stalen voorstuk voor relingpijp Ø 25 mm	Q	18,14	21,95	
	STEUN25A	Roestvast stalen eindstuk voor relingpijp Ø 25 mm	Q	18,14	21,95	
	STEUN25M	Roestvast stalen middenstuk voor relingpijp Ø 25 mm	Q	18,14	21,95	

SCEPTERS

	STANCH61	Scepter, lengte 610 mm, Ø 25 mm, met 2 gaten @305 / 600 mm	Q	88,43	107,00	
	STANCH75	Scepter, lengte 750 mm, Ø 25 mm, met 2 gaten @375 / 740 mm	Q	106,61	129,00	
	STANCHPR	Scepterpot, recht	Q	75,21	91,00	
	STANCHPS	Scepterpot, hoek van 6°	Q	75,21	91,00	



KIKKERS EN BOLDERS

396	TAURUS01	Kikker, RVS type TAURUS 1, lengte 140 mm	Q	33,02	39,95	
	TAURUS02	Kikker, RVS type TAURUS 2, lengte 195 mm	Q	45,45	55,00	
	TAURUS03	Kikker, RVS type TAURUS 3, lengte 255 mm	Q	71,90	87,00	
	TAURUS04	Kikker, RVS type TAURUS 4, lengte 300 mm	Q	95,04	115,00	
	TAURUS05	Kikker, RVS type TAURUS 5, lengte 300 mm	Q	132,23	160,00	
	TAURUS06	Kikker, RVS type TAURUS 6, lengte 300 mm	Q	134,71	163,00	
	TAURUS07	Kikker, RVS type TAURUS 7, lengte 255 mm	Q	149,59	181,00	
	ACHIL080	Bolder met voetplaat, type Achilles 80	Q	42,98	52,00	
	ACHIL090	Bolder met voetplaat, type Achilles 90	Q	47,11	57,00	
	ACHIL110	Bolder met voetplaat, type Achilles 110	Q	61,98	75,00	
	ACHIL130	Bolder met voetplaat, type Achilles 130	Q	68,60	83,00	
	ACHIL150	Bolder met voetplaat, type Achilles 150	Q	97,52	118,00	
	ACHIL160	Bolder met voetplaat, type Achilles 160	Q	162,81	197,00	
	ACHIL080Z	Lasbolder, type Achilles 80Z	Q	33,02	39,95	
	ACHIL090Z	Lasbolder, type Achilles 90Z	Q	37,15	44,95	
	ACHIL110Z	Lasbolder, type Achilles 110Z	Q	47,11	57,00	
	ACHIL130Z	Lasbolder, type Achilles 130Z	Q	52,89	64,00	
	ACHIL150Z	Lasbolder, type Achilles 150Z	Q	66,94	81,00	
	ACHIL160Z	Lasbolder, type Achilles 160Z	Q	125,62	152,00	
	ACHIL090B	Bolder voor boutmontage (M8)	Q	57,85	70,00	

STOOTLIJSTEN





STOOTLIJST TYPE HARO



Voor een complete stootlijst dient u een STOOTLIJST, AFDEKRAND en een set EINDSTUKKEN te bestellen.

398	HARO5034	Stootlijst type halfrond 50 x 34 mm, antraciet, rol van 20 meter (prijs per meter)	Q	18,14	21,95	
	HARO5034L	Stootlijst type halfrond 50 x 34 mm, antraciet, rol van 30 meter (prijs per meter)	Q	18,14	21,95	
	HARO50W	Stootlijst type halfrond 50 x 34 mm, wit, rol van 20 meter (prijs per meter)	Q	18,14	21,95	
	HARO50WL	Stootlijst type halfrond 50 x 34 mm, wit, rol van 30 meter (prijs per meter)	Q	18,14	21,95	
	HARO6035	Stootlijst type halfrond 60 x 35 mm, antraciet, rol van 20 meter (prijs per meter)	Q	25,58	30,95	
	HARO6035L	Stootlijst type halfrond 60 x 35 mm, antraciet, rol van 30 meter (prijs per meter)	Q	25,58	30,95	
	HARO60W	Stootlijst type halfrond 60 x 35 mm, wit, rol van 20 meter (prijs per meter)	Q	25,58	30,95	
	HARO60WL	Stootlijst type halfrond 60 x 35 mm, wit, rol van 30 meter (prijs per meter)	Q	25,58	30,95	

STOOTLIJST TYPE HARO5S

Voor een complete stootlijst dient u een STOOTLIJST, AFDEKRAND en een set EINDSTUKKEN te bestellen.

	HARO5S	Stootlijst type HARO5S, 50 x 34 mm, antraciet, rol van 20 meter (prijs per meter)	Q	18,14	21,95	
	HARO5SL	Stootlijst type HARO5S, 50 x 34 mm, antraciet, rol van 30 meter (prijs per meter)	Q	18,14	21,95	
	HARO5SW	Stootlijst type HARO5S, 50 x 34 mm, wit, rol van 20 meter (prijs per meter)	Q	18,14	21,95	
	HARO5SWL	Stootlijst type HARO5S, 50 x 34 mm, wit, rol van 30 meter (prijs per meter)	Q	18,14	21,95	
	STRIPB	Afdekrand voor stootlijst blauw, rol van 20 meter (prijs per meter)	Q	6,16	7,45	
	STRIPBL	Afdekrand voor stootlijst blauw, rol van 30 meter (prijs per meter)	Q	6,16	7,45	
	STRIPD	Afdekrand voor stootlijst antraciet, rol van 20 meter (prijs per meter)	Q	6,16	7,45	
	STRIPDL	Afdekrand voor stootlijst antraciet, rol van 30 meter (prijs per meter)	Q	6,16	7,45	
	STRIPG	Afdekrand voor stootlijst grijs, rol van 20 meter (prijs per meter)	Q	6,16	7,45	
	STRIPGL	Afdekrand voor stootlijst grijs, rol van 30 meter (prijs per meter)	Q	6,16	7,45	
	STRIPR	Afdekrand voor stootlijst rood, rol van 20 meter (prijs per meter)	Q	6,16	7,45	
	STRIPRL	Afdekrand voor stootlijst rood, rol van 30 meter (prijs per meter)	Q	6,16	7,45	
	HARO20S	RVS strip voor HARO5S stootlijst, 10 x 2 meter prijs per 20 m	Q	577,69	699,00	

	HARO30S	RVS strip voor HARO5S stootlijst, 15 x 2 meter prijs per 30 m	Q	842,15	1019,00
	EHARO50B	Set eindstukken, voor stootlijst type HARO50, zwart	Q	11,53	13,95
	EHARO50W	Set eindstukken, voor stootlijst type HARO50, wit	Q	11,53	13,95
	EHARO60B	Set eindstukken, voor stootlijst type HARO60, zwart	Q	11,53	13,95
	EHARO60W	Set eindstukken, voor stootlijst type HARO60, wit	Q	11,53	13,95
	HAROSE	Set eindstukken, voor stootlijst type HARO5S	Q	15,66	18,95

STOOTLIJST TYPE TRAP

Voor een complete stootlijst dient u een STOOTLIJST, AFDEKRAND en een set EINDSTUKKEN te bestellen.

399	TRAP5534	Stootlijst type trapezium 55 x 34 mm, antraciet, rol van 20 meter (prijs per meter)	Q	18,97	22,95
	TRAP5534L	Stootlijst type trapezium 55 x 34 mm, antraciet, rol van 30 meter (prijs per meter)	Q	18,97	22,95
	TRAP55W	Stootlijst type trapezium 55 x 34 mm, wit, rol van 20 meter (prijs per meter)	Q	18,97	22,95
	TRAP55WL	Stootlijst type trapezium 55 x 34 mm, wit, rol van 30 meter (prijs per meter)	Q	18,97	22,95
	TRAP6038	Stootlijst type trapezium 60 x 38 mm, antraciet, rol van 20 meter (prijs per meter)	Q	26,40	31,95
	TRAP6038L	Stootlijst type trapezium 60 x 38 mm, antraciet, rol van 30 meter (prijs per meter)	Q	26,40	31,95
	TRAP60W	Stootlijst type trapezium 60 x 38 mm, wit, rol van 20 meter (prijs per meter)	Q	26,40	31,95
	TRAP60WL	Stootlijst type trapezium 60 x 38 mm, wit, rol van 30 meter (prijs per meter)	Q	26,40	31,95
	TRAP7043	Stootlijst type trapezium 70 x 43 mm, antraciet, rol van 20 meter (prijs per meter)	Q	35,50	42,95
	TRAP7043L	Stootlijst type trapezium 70 x 43 mm, antraciet, rol van 30 meter (prijs per meter)	Q	35,50	42,95
	TRAP70W	Stootlijst type trapezium 70 x 50 mm, wit, rol van 20 meter (prijs per meter)	Q	35,50	42,95
	TRAP70WL	Stootlijst type trapezium 70 x 50 mm, wit, rol van 30 meter (prijs per meter)	Q	35,50	42,95

STOOTLIJST TYPE TRAPS5

Voor een complete stootlijst dient u een STOOTLIJST, AFDEKRAND en een set EINDSTUKKEN te bestellen.

	TRAP5S		Q	18,97	22,95
	TRAP5SL	Stootlijst type TRAP5S, 55 x 34 mm, antraciet, rol van 30 meter (prijs per meter)	Q	18,97	22,95
	TRAP5SW	Stootlijst type TRAP5S, 55 x 34 mm, wit, rol van 20 meter (prijs per meter)	Q	18,97	22,95
	TRAP5SWL	Stootlijst type TRAP5S, 55 x 34 mm, wit, rol van 30 meter (prijs per meter)	Q	18,97	22,95
	STRIPB	Afdekrand voor stootlijst blauw, rol van 20 meter (prijs per meter)	Q	6,16	7,45
	STRIPBL	Afdekrand voor stootlijst blauw, rol van 30 meter (prijs per meter)	Q	6,16	7,45
	STRIPD	Afdekrand voor stootlijst antraciet, rol van 20 meter (prijs per meter)	Q	6,16	7,45
	STRIPDL	Afdekrand voor stootlijst antraciet, rol van 30 meter (prijs per meter)	Q	6,16	7,45
	STRIPG	Afdekrand voor stootlijst grijs, rol van 20 meter (prijs per meter)	Q	6,16	7,45
	STRIPGL	Afdekrand voor stootlijst grijs, rol van 30 meter (prijs per meter)	Q	6,16	7,45
	STRIPR	Afdekrand voor stootlijst rood, rol van 20 meter (prijs per meter)	Q	6,16	7,45
	STRIPRL	Afdekrand voor stootlijst rood, rol van 30 meter (prijs per meter)	Q	6,16	7,45
	TRAP20S	RVS strip voor TRAP5S stootlijst, 10 x 2 meter prijs per 20 m	Q	693,39	839,00
	TRAP30S	RVS strip voor TRAP5S stootlijst, 15 x 2 meter prijs per 30 m	Q	1.032,23	1249,00
	ETRAP55B	Set eindstukken, voor stootlijst type TRAP55, zwart	Q	9,05	10,95
	ETRAP55W	Set eindstukken, voor stootlijst type TRAP55, wit	Q	9,05	10,95
	ETRAP60B	Set eindstukken, voor stootlijst type TRAP60, zwart	Q	9,05	10,95
	ETRAP60W	Set eindstukken, voor stootlijst type TRAP60, wit	Q	9,05	10,95
	ETRAP70B	Set eindstukken, voor stootlijst type TRAP70, zwart	Q	9,05	10,95
	ETRAP70W	Set eindstukken, voor stootlijst type TRAP70, wit	Q	9,05	10,95
	TRAPSE	Set eindstukken, voor stootlijst type TRAP5S	Q	15,66	18,95

STOOTLIJST TYPE POLY









Voor een complete stootlijst dient u een STOOTLIJST, AFDEKRAND en een set EINDSTUKKEN te bestellen.

400	POLY3026	Stootlijst type POLY 30 x 26 mm, antraciet, rol van 20 meter (prijs per meter)	Q	8,22	9,95
	POLY3026L	Stootlijst type POLY 30 x 26 mm, antraciet, rol van 30 meter (prijs per meter)	Q	8,22	9,95
	POLY30W	Stootlijst type POLY 30 x 26 mm, wit, rol van 20 meter (prijs per meter)	Q	8,22	9,95
	POLY30WL	Stootlijst type POLY 30 x 26 mm, wit, rol van 30 meter (prijs per meter)	Q	8,22	9,95
	POLY3528	Stootlijst type POLY 35 x 28 mm, antraciet, rol van 20 meter (prijs per meter)	Q	9,88	11,95
	POLY3528L	Stootlijst type POLY 35 x 28 mm, antraciet, rol van 30 meter (prijs per meter)	Q	9,88	11,95
	POLY35W	Stootlijst type POLY 35 x 28 mm, wit, rol van 20 meter (prijs per meter)	Q	9,88	11,95
	POLY35WL	Stootlijst type POLY 35 x 28 mm, wit, rol van 30 meter (prijs per meter)	Q	9,88	11,95
	POLY4031	Stootlijst type POLY 40 x 31 mm, antraciet, rol van 20 meter (prijs per meter)	Q	14,01	16,95
	POLY4031L	Stootlijst type POLY 40 x 31 mm, antraciet, rol van 30 meter (prijs per meter)	Q	14,01	16,95
	POLY40W	Stootlijst type POLY 40 x 31 mm, wit, rol van 20 meter (prijs per meter)	Q	14,01	16,95
	POLY40WL	Stootlijst type POLY 40 x 31 mm, wit, rol van 30 meter (prijs per meter)	Q	14,01	16,95



STOOTLIJST TYPE POLY4S

Voor een complete stootlijst dient u een STOOTLIJST, AFDEKRAND en een set EINDSTUKKEN te bestellen.





POLY4S		Q	14,01	16,95	
POLY4SL	Stootlijst type POLY4S, 40 x 31 mm, antraciet, rol van 30 meter (prijs per meter)	Q	14,01	16,95	
POLY4SW	Stootlijst type POLY4S, 40 x 31 mm, wit, rol van 20 meter (prijs per meter)	Q	14,01	16,95	
POLY4SWL	Stootlijst type POLY4S, 40 x 31 mm, wit, rol van 30 meter (prijs per meter)	Q	14,01	16,95	
STRIPB	Afdekrand voor stootlijst blauw, rol van 20 meter (prijs per meter)	Q	6,16	7,45	
STRIPBL	Afdekrand voor stootlijst blauw, rol van 30 meter (prijs per meter)	Q	6,16	7,45	
STRIPD	Afdekrand voor stootlijst antraciet, rol van 20 meter (prijs per meter)	Q	6,16	7,45	
STRIPDL	Afdekrand voor stootlijst antraciet, rol van 30 meter (prijs per meter)	Q	6,16	7,45	
STRIPG	Afdekrand voor stootlijst grijs, rol van 20 meter (prijs per meter)	Q	6,16	7,45	
STRIPGL	Afdekrand voor stootlijst grijs, rol van 30 meter (prijs per meter)	Q	6,16	7,45	
STRIPR	Afdekrand voor stootlijst rood, rol van 20 meter (prijs per meter)	Q	6,16	7,45	
STRIPRL	Afdekrand voor stootlijst rood, rol van 30 meter (prijs per meter)	Q	6,16	7,45	
POLY20S	RVS strip voor POLY4S stootlijst, 10 x 2 meter prijs per 20m	Q	445,45	539,00	
POLY30S	RVS strip voor POLY4S stootlijst, 15 x 2 meter prijs per 30m	Q	718,18	869,00	
EPOLY40B	Set eindstukken voor stootlijst type POLY40, zwart	Q	9,05	10,95	
EPOLY40W	Set eindstukken voor stootlijst type POLY40, wit	Q	9,05	10,95	
EPOLY30B	Set eindstukken voor stootlijst type POLY30, zwart	Q	9,05	10,95	
EPOLY30W	Set eindstukken voor stootlijst type POLY30, wit	Q	9,05	10,95	
EPOLY35B	Set eindstukken voor stootlijst type POLY35, zwart	Q	9,05	10,95	
EPOLY35W	Set eindstukken voor stootlijst type POLY35, wit	Q	9,05	10,95	
POLYSE	Set eindstukken, voor stootlijst type POLY4S	Q	15,66	18,95	

STOOTLIJST TYPE STE



401	STE4838	Stootlijst type STE 48 x 38 mm. compleet, rol van 20 mtr.(prijs per meter)	Q	45,45	55,00	
	STE4838L	Stootlijst type STE 48 x 38 mm. compleet, rol van 30 mtr.(prijs per meter)	Q	45,45	55,00	

STOOTLIJST TYPE ROND

Voor een complete stootlijst dient u een STOOTLIJST en AFDEKRAND te bestellen.

ROND4248	Stootlijst type ROND 4248 mm, antraciet, rol van 20 mtr. (prijs per meter)	Q	14,01	16,95	
ROND4248L	Stootlijst type ROND 4248 mm, antraciet, rol van 30 mtr. (prijs per meter)	Q	14,01	16,95	
STRIPB	Afdekrand voor stootlijst blauw, rol van 20 meter (prijs per meter)	Q	6,16	7,45	
STRIPBL	Afdekrand voor stootlijst blauw, rol van 30 meter (prijs per meter)	Q	6,16	7,45	
STRIPD	Afdekrand voor stootlijst antraciet, rol van 20 meter (prijs per meter)	Q	6,16	7,45	
STRIPDL	Afdekrand voor stootlijst antraciet, rol van 30 meter (prijs per meter)	Q	6,16	7,45	
STRIPG	Afdekrand voor stootlijst grijs, rol van 20 meter (prijs per meter)	Q	6,16	7,45	
STRIPGL	Afdekrand voor stootlijst grijs, rol van 30 meter (prijs per meter)	Q	6,16	7,45	
STRIPR	Afdekrand voor stootlijst rood, rol van 20 meter (prijs per meter)	Q	6,16	7,45	
STRIPRL	Afdekrand voor stootlijst rood, rol van 30 meter (prijs per meter)	Q	6,16	7,45	

ZOEK- EN NAVIGATIE VERLICHTING

402	Z5032LED	LED zoeklicht Ø150 mm, 10W, 10-32V	Q	1.073,55	1299,00	
	Z7032LED	LED zoeklicht Ø180 mm, 10W, 10-32V	Q	1.114,88	1349,00	
	ZN215	Zoeklicht Ø 215 mm, 12/24 of 230 Volt, stuurhuis-bediening (excl.halogeonlamp)	Q	784,30	949,00	
	LAMP50LED	Vervangend LED (10W) voor Ø150 mm zoeklicht	Q	453,72	549,00	
	LAMP80LED	Vervangend LED (10W) voor Ø180 mm zoeklicht	Q	900,00	1089,00	

















Alle navigatieverlichting wordt geleverd zonder lamp. Om aan de eisen van I.M.O te voldoen moet bij iedere lantaarn van de modellen 35 en 55 apart een goedgekeurde lamp worden besteld, type LAMP1225 of LAMP2425.

403	SB35ZWIT	Stuurboordlantaarn (zijmontage),wit huis (excl. lamp)	Q	78,51	95,00	
	BB35ZWIT	Bakboordlantaarn(zijmontage),wit huis (excl. lamp)	Q	78,51	95,00	
	TW35ZWIT	Toplantaarn(wandmontage),wit huis (excl. lamp)	Q	78,51	95,00	
	HW35ZWIT	Heklantaarn(wandmontage),wit huis (excl. lamp)	Q	78,51	95,00	
	TKL35VWIT	Tweekleuren-lantaarn (voetmontage), wit huis (excl. lamp)	Q	85,12	103,00	
	DKL35VWIT	Driekleuren-lantaarn (voetmontage), wit huis (excl. lamp)	Q	85,95	104,00	
	RW35VWIT	Rondschijnend, wit (voetmontage), wit huis (excl. lamp)	Q	71,90	87,00	
	RR35VWIT	Rondschijnend, rood(voetmontage), wit huis (excl. lamp)	Q	71,90	87,00	
	RG35VWIT	Rondschijnend, groen (voetmontage), wit huis (excl. lamp)	Q	71,90	87,00	
	RW35HWIT	Rondschijnend, wit (hijsbaar),wit huis (excl. lamp)	Q	71,90	87,00	
	RR35HWIT	Rondschijnend, rood(hijsbaar),wit huis (excl. lamp)	Q	71,90	87,00	
	RGR35HWIT	Rondschijnend, groen (hijsbaar),wit huis (excl. lamp)	Q	71,90	87,00	
	SB35Z	Stuurboordlantaarn(zijmontage),zwart huis (excl. lamp)	Q	85,12	103,00	
	BB35Z	Bakboordlantaarn(zijmontage),zwart huis (excl. lamp)	Q	85,12	103,00	
	TW35Z	Toplantaarn (wandmontage),zwart huis (excl. lamp)	Q	85,12	103,00	



	HW35Z	Heklantaarn (wandmontage),zwart huis (excl. lamp)	Q	85,12	103,00
	TKL35V	Tweekleuren-lantaarn(voetmontage), zwart huis (excl. lamp)	Q	95,04	115,00
	DKL35V	Driekleuren-lantaarn(voetmontage), zwart huis (excl. lamp)	Q	95,04	115,00
	RW35V	Rondschildnend, wit(voetmontage), zwart huis (excl. lamp)	Q	80,99	98,00
	RR35V	Rondschildnend, rood (voetmontage), zwart huis (excl. lamp)	Q	80,99	98,00
	RG35V	Rondschildnend, groen(voetmontage), zwart huis (excl. lamp)	Q	80,99	98,00
	RW35H	Rondschildnend, wit(hijsbaar),zwart huis (excl. lamp)	Q	80,99	98,00
	RR35H	Rondschildnend, rood (hijsbaar),zwart huis (excl. lamp)	Q	80,99	98,00
	RGR35H	Rondschildnend, groen(hijsbaar),zwart huis (excl. lamp)	Q	80,99	98,00
	SB55VN	Stuurboordlantaarn(voetmontage), zwart huis (excl. lamp)	Q	127,27	154,00
	BB55VN	Bakboordlantaarn(voetmontage), zwart huis (excl. lamp)	Q	127,27	154,00
	TW55VN	Toplantaarn (voetmontage), zwart huis (excl. lamp)	Q	127,27	154,00
	HW55VN	Heklantaarn (voetmontage), zwart huis (excl. lamp)	Q	127,27	154,00
	HGL55VN	Sleeplicht, geel (voetmontage), zwart huis (excl. lamp)	Q	127,27	154,00
	RW55VN	Rondschildnend, wit(voetmontage), zwart huis (excl. lamp)	Q	123,97	150,00
	RR55VN	Rondschildnend, rood (voetmontage), zwart huis (excl. lamp)	Q	123,97	150,00
	RGL55VN	Rondschildnend, geel(voetmontage), zwart huis (excl. lamp)	Q	113,22	137,00
	RGR55VN	Rondschildnend, groen(voetmontage), zwart huis (excl. lamp)	Q	123,97	150,00
	SETH55	Set om navigatielantaarns type 55 hijsbaar te maken	Q	37,98	45,95

ROESTVAST STALEN FITTINGEN







404	QJ05MC-NN	Waterschep, roestvast staal, G3/8"	Q	23,10	27,95
	QJ05MD-NN	Waterschep, roestvast staal, G1/2"	Q	25,58	30,95
	QJ05ME-NN	Waterschep, roestvast staal, G3/4"	Q	30,54	36,95
	QJ05MF-NN	Waterschep, roestvast staal, G1"	Q	35,50	42,95
	QJ05MG-NN	Waterschep, roestvast staal, G1 1/4"	Q	40,45	48,95
	QJ05MH-NN	Waterschep, roestvast staal, G1 1/2"	Q	50,41	61,00
	QJ05MI-NN	Waterschep, roestvast staal, G2"	Q	66,94	81,00
	QH05MD-NN	Ventilatie fitting, roestvast staal, gepolijst, G1/2"	Q	14,01	16,95
	QH05ME-NN	Ventilatie fitting, roestvast staal, gepolijst, G3/4"	Q	14,01	16,95
	QH05MF-NN	Ventilatie fitting, roestvast staal, gepolijst, G1"	Q	23,10	27,95
	QH05MG-NN	Ventilatie fitting, roestvast staal, gepolijst, G1 1/4"	Q	30,54	36,95
	QH05MH-NN	Ventilatie fitting, roestvast staal, gepolijst, G1 1/2"	Q	39,63	47,95
	QH05MI-NN	Ventilatie fitting, roestvast staal, gepolijst, G2"	Q	57,02	69,00
	QA05MC-15	Slang connector, roestvast staal, externe draad, G3/8", slang Ø 15 mm	Q	4,50	5,45
	QA05MD-12	Slang connector, roestvast staal, externe draad, G3/8", slang Ø 12 mm	Q	5,33	6,45
	QA05MD-15	Slang connector, roestvast staal, externe draad, G1/2", slang Ø 15 mm	Q	5,33	6,45
	QA05MD-20	Slang connector, roestvast staal, externe draad, G1/2", slang Ø 20 mm	Q	5,33	6,45
	QA05ME-20	Slang connector, roestvast staal, externe draad, G3/4", slang Ø 20 mm	Q	7,81	9,45
	QA05ME-25	Slang connector, roestvast staal, externe draad, G3/4", slang Ø 25 mm	Q	7,81	9,45
	QA05MF-25	Slang connector, roestvast staal, externe draad, G1", slang Ø 25 mm	Q	12,36	14,95
	QA05MF-30	Slang connector, roestvast staal, externe draad, G1", slang Ø 30 mm	Q	12,36	14,95
	QA05MG-32	Slang connector, roestvast staal, externe draad, G1 1/4", slang Ø 32 mm	Q	16,49	19,95
	QA05MG-35	Slang connector, roestvast staal, externe draad, G1 1/4", slang Ø 35 mm	Q	18,14	21,95
	QA05MG-38	Slang connector, roestvast staal, externe draad, G1 1/4", slang Ø 38 mm	Q	21,45	25,95
	QA05MH-38	Slang connector, roestvast staal, externe draad, G1 1/2", slang Ø 38 mm	Q	31,36	37,95
	QA05MH-45	Slang connector, roestvast staal, externe draad, G1 1/2", slang Ø 45 mm	Q	33,02	39,95
	QA05MI-50	Slang connector, roestvast staal, externe draad, G2", slang Ø 50 mm	Q	33,02	39,95
	QA05FC-15	Slang connector, roestvast staal, interne draad, G3/8", slang Ø 15 mm	Q	4,05	4,90
	QA05FD-15	Slang connector, roestvast staal, interne draad, G1/2", slang Ø 15 mm	Q	6,16	7,45
	QA05FD-20	Slang connector, roestvast staal, interne draad, G1/2", slang Ø 20 mm	Q	6,57	7,95
	QA05FE-20	Slang connector, roestvast staal, interne draad, G3/4", slang Ø 20 mm	Q	7,40	8,95
	QA05FF-25	Slang connector, roestvast staal, interne draad, G1", slang Ø 25 mm	Q	12,36	14,95
	QA05FG-35	Slang connector, roestvast staal, interne draad, G1 1/4", slang Ø 35 mm	Q	20,62	24,95
QA05FG-40	Slang connector, roestvast staal, interne draad, G1 1/4", slang Ø 40 mm	Q	23,10	27,95	
QA05FH-45	Slang connector, roestvast staal, interne draad, G1 1/2", slang Ø 45 mm	Q	25,58	30,95	
QA05FI-50	Slang connector, roestvast staal, interne draad, G2", slang Ø 50 mm	Q	31,36	37,95	
405	QB05FD-19	Slangpilaar 90° AISI 316 interne draad G1/2", slang 19 mm	Q	9,05	10,95
	QB05FE-25	Slangpilaar 90° AISI 316 interne draad G3/4", slang 25 mm	Q	12,36	14,95
	QB05FF-30	Slangpilaar 90° AISI 316 interne draad G1", slang 30 mm	Q	14,01	16,95
	QB05FH-39	Slangpilaar 90° AISI 316 interne draad G1 1/2", slang 39 mm	Q	26,40	31,95
	QB05FH-50	Slangpilaar 90° AISI 316 interne draad G1 1/2", slang 50 mm	Q	31,36	37,95
	QB05MD-20	Slangpilaar gebogen AISI 316 externe draad G1/2", slang 20 mm	Q	11,53	13,95
	QB05ME-25	Slangpilaar gebogen AISI 316 externe draad G3/4", slang 25 mm	Q	14,01	16,95
	QB05MF-30	Slangpilaar gebogen AISI 316 externe draad G1", slang 30 mm	Q	18,97	22,95

	QB05MG-38	Slangpilaar gebogen AISI 316 externe draad G1 1/4", slang 38 mm	Q	26,40	31,95	
	THRU1/2S	Huiddoorvoer, roestvast staal, afgeschuinde flens, brushed, G½	Q	23,93	28,95	
	THRU3/4S	Huiddoorvoer, roestvast staal, afgeschuinde flens, brushed, G¾	Q	26,40	31,95	
	THRU1S	Huiddoorvoer, roestvast staal, afgeschuinde flens, brushed, G1	Q	35,50	42,95	
	THRU11/4S	Huiddoorvoer, roestvast staal, afgeschuinde flens, brushed, G1¼	Q	54,55	66,00	
	THRU11/2S	Huiddoorvoer, roestvast staal, afgeschuinde flens, brushed, G1½	Q	59,50	72,00	
	THRU2S	Huiddoorvoer, roestvast staal, afgeschuinde flens, brushed, G2	Q	74,38	90,00	
	QD05MC-NN	Huiddoorvoer, roestvast staal, afgeronde flens, gepolijst, G3/8"	Q	14,01	16,95	
	QD05MD-NN	Huiddoorvoer, roestvast staal, afgeronde flens, gepolijst, G1/2"	Q	14,01	16,95	
	QD05ME-NN	Huiddoorvoer, roestvast staal, afgeronde flens, gepolijst, G3/4"	Q	18,14	21,95	
	QD05MF-NN	Huiddoorvoer, roestvast staal, afgeronde flens, gepolijst, G1"	Q	26,40	31,95	
	QD05MG-NN	Huiddoorvoer, roestvast staal, afgeronde flens, gepolijst, G1 1/4"	Q	30,54	36,95	
	QD05MH-NN	Huiddoorvoer, roestvast staal, afgeronde flens, gepolijst, G1 1/2"	Q	35,50	42,95	
	QD05MI-NN	Huiddoorvoer, roestvast staal, afgeronde flens, gepolijst, G2"	Q	66,94	81,00	
	QF05MC-14	Huiddoorvoer, roestvast staal, afgeronde flens, gepolijst, G3/8", met slang connectie Ø 14 mm	Q	14,01	16,95	
	QF05MD-18	Huiddoorvoer, roestvast staal, afgeronde flens, gepolijst, G1/2", met slang connectie Ø 18 mm	Q	14,01	16,95	
	QF05ME-23	Huiddoorvoer, roestvast staal, afgeronde flens, gepolijst, G3/4", met slang connectie Ø 23 mm	Q	18,14	21,95	
	QF05MF-29	Huiddoorvoer, roestvast staal, afgeronde flens, gepolijst, G1", met slang connectie Ø 29 mm	Q	26,40	31,95	
	QF05MG-38	Huiddoorvoer, roestvast staal, afgeronde flens, gepolijst, G1 1/4", met slang connectie Ø 38 mm	Q	30,54	36,95	
	QF05MH-44	Huiddoorvoer, roestvast staal, afgeronde flens, gepolijst, G1 1/2", met slang connectie Ø 44 mm	Q	35,50	42,95	
	QF05MI-55	Huiddoorvoer, roestvast staal, afgeronde flens, gepolijst, G2", met slang connectie Ø 55 mm	Q	61,16	74,00	
406	QE05MC-NN	Huiddoorvoer, roestvast staal, vlakke flens, gepolijst, G3/8"	Q	14,01	16,95	
	QE05MD-NN	Huiddoorvoer, roestvast staal, vlakke flens, gepolijst, G1/2"	Q	14,01	16,95	
	QE05ME-NN	Huiddoorvoer, roestvast staal, vlakke flens, gepolijst, G3/4"	Q	16,49	19,95	
	QE05MF-NN	Huiddoorvoer, roestvast staal, vlakke flens, gepolijst, G1"	Q	28,88	34,95	
	QE05MG-NN	Huiddoorvoer, roestvast staal, vlakke flens, gepolijst, G1 1/4"	Q	31,36	37,95	
	QE05MH-NN	Huiddoorvoer, roestvast staal, vlakke flens, gepolijst, G1 1/2"	Q	40,45	48,95	
	QE05MI-NN	Huiddoorvoer, roestvast staal, vlakke flens, gepolijst, G2"	Q	66,12	80,00	
	QG05MC-15	Huiddoorvoer, roestvast staal, vlakke flens, gepolijst, G3/8", met slang connectie Ø 15 mm	Q	14,01	16,95	
	QG05MD-18	Huiddoorvoer, roestvast staal, vlakke flens, gepolijst, G1/2", met slang connectie Ø 18 mm	Q	14,01	16,95	
	QG05ME-22	Huiddoorvoer, roestvast staal, vlakke flens, gepolijst, G3/4", met slang connectie Ø 22 mm	Q	16,49	19,95	
	QG05MF-29	Huiddoorvoer, roestvast staal, vlakke flens, gepolijst, G1", met slang connectie Ø 29 mm	Q	28,88	34,95	
	QG05MG-38	Huiddoorvoer, roestvast staal, vlakke flens, gepolijst, G1 1/4", met slang connectie Ø 38 mm	Q	31,36	37,95	
	QG05MH-43	Huiddoorvoer, roestvast staal, vlakke flens, gepolijst, G1 1/2", met slang connectie Ø 43 mm	Q	40,45	48,95	
	QG05MI-55	Huiddoorvoer, roestvast staal, vlakke flens, gepolijst, G2", met slang connectie Ø 55 mm	Q	66,12	80,00	

ROESTVAST STAAL (AISI 316) KOGELKRANEN

	BV1/2	Kogelkraan, roestvast staal, G½	Q	18,14	21,95	
	BV3/4	Kogelkraan, roestvast staal, G¾	Q	26,40	31,95	
	BV1	Kogelkraan, roestvast staal, G1	Q	37,98	45,95	
	BV11/4	Kogelkraan, roestvast staal, G1¼	Q	59,50	72,00	
	BV11/2	Kogelkraan, roestvast staal, G1½	Q	82,64	100,00	
	BV2	Kogelkraan, roestvast staal, G2	Q	132,23	160,00	

BRONZEN (ISO CUPB5SN5ZN5) FITTINGEN

	WCAPB1/2	Waterschep, brons, G 1/2	Q	37,15	44,95	
	WCAPB3/4	Waterschep, brons, G 3/4	Q	57,85	70,00	
	WCAPB1	Waterschep, brons, G 1	Q	66,94	81,00	
	WCAPB11/4	Waterschep, brons, G1,25	Q	87,60	106,00	
	WCAPB11/2	Waterschep, brons, G1,5	Q	125,62	152,00	
407	THRUB1/2	Huiddoorvoer, brons, G 1/2	Q	18,97	22,95	
	THRUB3/4	Huiddoorvoer, brons, G 3/4	Q	26,40	31,95	
	THRUB1	Huiddoorvoer, brons, G1	Q	33,02	39,95	
	THRUB11/4	Huiddoorvoer, brons, G1,25	Q	42,98	52,00	
	THRUB11/2	Huiddoorvoer, brons, G1,5	Q	52,07	63,00	
	HPB1/2	Slang connector, brons, G 1/2 x 13 mm	Q	6,98	8,45	
	HPB3/4	Slang connector, brons, G 3/4 x 19 mm	Q	10,70	12,95	
	HPB1	Slang connector, brons, G 1 x 25 mm	Q	15,66	18,95	
	HPB11/4	Slang connector, brons, G 1 1/4 x 32 mm	Q	21,45	25,95	
	HPB11/2	Slang connector, brons, G 1 1/2 x 38 mm	Q	30,54	36,95	
	MAN2G1/2	Verdeelstuk, brons, met 1 x G 3/4 draad binnen/buiten, and 2 x G 1/2 draad binnen	Q	28,88	34,95	
	MAN3G1/2	Verdeelstuk, brons, met 1 x G 3/4 draad binnen/buiten, and 3 x G 1/2 draad binnen	Q	39,63	47,95	
	MAN2G3/4	Verdeelstuk, brons, met 1 x G 1 draad binnen/buiten, and 2 x G 3/4 draad binnen	Q	40,45	48,95	
	MAN3G3/4	Verdeelstuk, brons, met 1 x G 1 draad binnen/buiten, and 3 x G 3/4 draad binnen	Q	50,41	61,00	

BRONZEN (ISO CUPB5SN5ZN5) KOGELKRANEN

	BVB1/2	Kogelkraan, brons, G 1/2	Q	26,40	31,95
	BVB3/4	Kogelkraan, brons, G 3/4	Q	34,67	41,95
	BVB1	Kogelkraan, brons, G 1	Q	52,07	63,00
	BVB11/4	Kogelkraan, brons, G 1 1/4	Q	88,43	107,00
	BVB11/2	Kogelkraan, brons, G 1 1/2	Q	100,83	122,00











MESSING FITTINGEN

408	WCAP1/2	Waterschep messing, G $\frac{1}{2}$	Q	23,93	28,95
	WCAP3/4	Waterschep messing, G $\frac{3}{4}$	Q	30,54	36,95
	WCAP1	Waterschep messing, G1	Q	33,02	39,95
	WCAP11/4	Waterschep messing, G1 $\frac{1}{4}$	Q	39,63	47,95
	WCAP11/2	Waterschep messing, G1 $\frac{1}{2}$	Q	59,50	72,00
	WCAP2	Waterschep messing, G2	Q	98,35	119,00
	WCAP21/2	Waterschep messing, G2 $\frac{1}{2}$	Q	160,33	194,00
	WCAP3	Waterschep messing, G3	Q	205,79	249,00
	DOORB3/8	Huiddoorvoer messing, G $\frac{3}{8}$	Q	11,53	13,95
	DOORB1/2	Huiddoorvoer messing, G $\frac{1}{2}$	Q	12,36	14,95
	DOORB3/4	Huiddoorvoer messing, G $\frac{3}{4}$	Q	20,62	24,95
	DOORB1	Huiddoorvoer messing, G1	Q	21,45	25,95
	DOORB11/4	Huiddoorvoer messing, G1 $\frac{1}{4}$	Q	28,06	33,95
	DOORB11/2	Huiddoorvoer messing, G1 $\frac{1}{2}$	Q	33,02	39,95
	DOORB2	Huiddoorvoer messing, G2	Q	47,11	57,00
	DOORB21/2	Huiddoorvoer messing, G2 $\frac{1}{2}$	Q	92,56	112,00
	DOORB3	Huiddoorvoer messing, G3	Q	126,45	153,00
	HPM1/2B	Slang pilaar, messing, 90 graden gebogen, G 1/2, slang Ø 13 mm	Q	10,70	12,95
	HPM3/4B	Slang pilaar, messing, 90 graden gebogen, G 3/4, slang Ø 19 mm	Q	15,66	18,95
	HPM1B	Slang pilaar, messing, 90 graden gebogen, G 1, slang Ø 25 mm	Q	18,97	22,95
	HPM11/4B	Slang pilaar, messing, 90 graden gebogen, G 1 1/4, slang Ø 32 mm	Q	25,58	30,95
	HPM11/2B	Slang pilaar, messing, 90 graden gebogen, G 1 1/2, slang Ø 38 mm	Q	31,36	37,95
409	SLP1/408	Slang connector messing, G $\frac{1}{4}$, slang Ø 8 mm	Q	3,06	3,70
	SLP1/416	Slang connector messing, G $\frac{1}{4}$, slang Ø 16 mm	Q	3,47	4,20
	SLP3/810	Slang connector messing, G $\frac{3}{8}$, slang Ø 10 mm	Q	3,06	3,70
	SLP3/815	Slang connector messing, G $\frac{3}{8}$, slang Ø 15 mm	Q	2,31	2,80
	SLP1/213	Slang connector messing, G $\frac{1}{2}$, slang Ø 13 mm	Q	3,47	4,20
	SLP1/216	Slang connector messing, G $\frac{1}{2}$, slang Ø 16 mm	Q	3,80	4,60
	SLP1/219	Slang connector messing, G $\frac{1}{2}$, slang Ø 19 mm	Q	3,80	4,60
	SLP3/416	Slang connector messing, G $\frac{3}{4}$, slang Ø 16 mm	Q	4,92	5,95
	SLP3/419	Slang connector messing, G $\frac{3}{4}$, slang Ø 19 mm	Q	4,05	4,90
	SLP3/425	Slang connector messing, G $\frac{3}{4}$, slang Ø 25 mm	Q	6,16	7,45
	SLP125	Slang connector messing, G 1, slang Ø 25 mm	Q	6,16	7,45
	SLP132	Slang connector messing, G 1, slang Ø 32 mm	Q	7,40	8,95
	SLP11/432	Slang connector messing, G1 $\frac{1}{4}$, slang Ø 32 mm	Q	8,22	9,95
	SLP11/438	Slang connector messing, G1 $\frac{1}{4}$, slang Ø 38 mm	Q	11,53	13,95
	SLP11/238	Slang connector messing, G1 $\frac{1}{2}$, slang Ø 38 mm	Q	14,01	16,95
	SLP11/245	Slang connector messing, G1 $\frac{1}{2}$, slang Ø 45 mm	Q	15,66	18,95
	SLP251	Slang connector messing, G 2, slang Ø 51 mm	Q	18,97	22,95
	SLP21/260	Slang connector messing, G2 $\frac{1}{2}$, slang Ø 60 mm	Q	44,63	54,00
	SLP376	Slang connector messing, G 3, slang Ø 76 mm	Q	61,16	74,00



VERNIKKELD MESSING KOGELKRANEN

	KRAAN1/4	Kogelkraan, Vernikkeld messing, G $\frac{1}{4}$	Q	9,05	10,95
	KRAAN3/8	Kogelkraan, Vernikkeld messing, G $\frac{3}{8}$	Q	9,88	11,95
	KRAAN1/2	Kogelkraan, Vernikkeld messing, G $\frac{1}{2}$	Q	9,88	11,95
	KRAAN3/4	Kogelkraan, Vernikkeld messing, G $\frac{3}{4}$	Q	14,01	16,95
	KRAAN1	Kogelkraan, Vernikkeld messing, G1	Q	20,62	24,95
	KRAAN11/4	Kogelkraan, Vernikkeld messing, G1 $\frac{1}{4}$	Q	33,02	39,95
	KRAAN11/2	Kogelkraan, Vernikkeld messing, G1 $\frac{1}{2}$	Q	47,11	57,00
	KRAAN2	Kogelkraan, Vernikkeld messing, G2	Q	69,42	84,00
	KRAAN21/2	Kogelkraan, Vernikkeld messing, G2 $\frac{1}{2}$	Q	197,52	239,00
	KRAAN3	Kogelkraan, Vernikkeld messing, G3	Q	201,65	244,00
	KRA1/2L	Kogelkraan, Vernikkeld messing, G $\frac{1}{2}$ L, 3-weg	Q	47,93	58,00
	KRA3/4L	Kogelkraan, Vernikkeld messing, G $\frac{3}{4}$ L, 3-weg	Q	59,50	72,00
	KRA1L	Kogelkraan, Vernikkeld messing, G1 L, 3-weg	Q	85,95	104,00
	KRA11/4L	Kogelkraan, Vernikkeld messing, G1 $\frac{1}{4}$ L, 3-weg	Q	119,83	145,00
	KRA11/2L	Kogelkraan, Vernikkeld messing, G1 $\frac{1}{2}$ L, 3-weg	Q	192,56	233,00











DELTRIN FITTINGEN















410	DOORN5/8	Huiddoorvoer, Delrin, G $\frac{5}{8}$, voor slang Ø 16 mm	Q	4,50	5,45	
	DOORN3/4	Huiddoorvoer, Delrin, G $\frac{3}{4}$, voor slang Ø 19 mm	Q	4,92	5,95	
	DOORN1	Huiddoorvoer, Delrin, G 1, voor slang Ø 25 mm	Q	6,16	7,45	
	DOORN11/4	Huiddoorvoer, Delrin, G1 $\frac{1}{4}$, voor slang Ø 32 mm	Q	6,16	7,45	
	DOORN11/2	Huiddoorvoer, Delrin, G1 $\frac{1}{2}$, voor slang Ø 38 mm	Q	7,40	8,95	
	THR16	Huiddoorvoer, Delrin, voor slang Ø 16 mm (5/8")	Q	10,70	12,95	
	THR19	Huiddoorvoer, Delrin, voor slang Ø 19 mm (3/4")	Q	12,36	14,95	
	THR25	Huiddoorvoer, Delrin, voor slang Ø 25 mm (1")	Q	16,49	19,95	
	THR28	Huiddoorvoer, Delrin, voor slang Ø 28 mm (1 1/8")	Q	16,49	19,95	
	THR32	Huiddoorvoer, Delrin, voor slang Ø 32 mm (1 1/4")	Q	16,49	19,95	
	THR38	Huiddoorvoer, Delrin, voor slang Ø 38 mm (1 1/2")	Q	21,45	25,95	
	THR16L	Huiddoorvoer met L- flens, Delrin, voor slang Ø 16 mm (5/8")	Q	9,88	11,95	
	THR19L	Huiddoorvoer met L- flens, Delrin, voor slang Ø 19 mm (3/4")	Q	12,36	14,95	
	THR25L	Huiddoorvoer met L- flens, Delrin, voor slang Ø 25 mm (1")	Q	16,49	19,95	
	THR28L	Huiddoorvoer met L- flens, Delrin, voor slang Ø 28 mm (1 1/8")	Q	16,49	19,95	
	THR32L	Huiddoorvoer met L- flens, Delrin, voor slang Ø 32 mm (1 1/4")	Q	18,14	21,95	
	THR38L	Huiddoorvoer met L- flens, Delrin, voor slang Ø 38 mm (1 1/2")	Q	21,45	25,95	
411	THR25BH	Huiddoorvoer, 90 graden gebogen met hoge flens, Delrin, voor slang Ø 25 mm (1")	Q	21,45	25,95	
	THR28BH	Huiddoorvoer, 90 graden gebogen met hoge flens, Delrin, voor slang Ø 28 mm (1 1/8")	Q	21,45	25,95	
	THR25BL	Huiddoorvoer, 90 graden gebogen met lage flens, Delrin, voor slang Ø 25 mm (1")	Q	26,40	31,95	
	THR28BL	Huiddoorvoer, 90 graden gebogen met lage flens, Delrin, voor slang Ø 28 mm (1 1/8")	Q	26,40	31,95	
	BULK16	Schotdoorvoer, Delrin, voor slang Ø 16 mm (5/8")	Q	18,97	22,95	
	BULK19	Schotdoorvoer, Delrin, voor slang Ø 19 mm (3/4")	Q	23,93	28,95	
	BULK25	Schotdoorvoer, Delrin, voor slang Ø 25 mm (1")	Q	31,36	37,95	
	BULK28	Schotdoorvoer, Delrin, voor slang Ø 28 mm (1 1/8")	Q	28,88	34,95	
	BULK32	Schotdoorvoer, Delrin, voor slang Ø 32 mm (1 1/4")	Q	28,88	34,95	
	BULK38	Schotdoorvoer, Delrin, voor slang Ø 38 mm (1 1/2")	Q	40,45	48,95	















KUNSTSTOF T-STUKKEN

	TPC16	T-stuk voor slang Ø 16 mm (5/8")	Q	15,66	18,95	
	TPC19	T-stuk voor slang Ø 19 mm (3/4")	Q	14,01	16,95	
	TPC25	T-stuk voor slang Ø 25 mm (1")	Q	14,01	16,95	
	TPC28	T-stuk voor slang Ø 28 mm (1 1/8")	Q	14,01	16,95	

APPENDAGES



412	QS050203	Afdekdop AISI 316 externe draad G3/8"	Q	2,64	3,20	
	QS050204	Afdekdop AISI 316 externe draad G1/2"	Q	3,22	3,90	
	QS050205	Afdekdop AISI 316 externe draad G3/4"	Q	4,50	5,45	
	QS050206	Afdekdop AISI 316 externe draad G1"	Q	6,57	7,95	
	QS050207	Afdekdop AISI 316 externe draad G1 1/4"	Q	9,88	11,95	
	QS050208	Afdekdop AISI 316 externe draad G1 1/2"	Q	12,36	14,95	
	QS050209	Afdekdop AISI 316 externe draad G2"	Q	18,14	21,95	
	QS050603	Zeskant bus AISI 316 externe draad - interne draad G3/8" - G1/4"	Q	2,56	3,10	
	QS050604	Zeskant bus AISI 316 externe draad - interne draad G1/2" - G3/8"	Q	2,81	3,40	
	QS050605	Zeskant bus AISI 316 externe draad - interne draad G3/4" - G1/2"	Q	4,50	5,45	
	QS050606	Zeskant bus AISI 316 externe draad - interne draad G1" - G3/4"	Q	5,33	6,45	
	QS050607	Zeskant bus AISI 316 externe draad - interne draad G1 1/4" - G1"	Q	8,22	9,95	
	QS050608	Zeskant bus AISI 316 externe draad - interne draad G1 1/2" - G1 1/4"	Q	9,88	11,95	
	QS050609	Zeskant bus AISI 316 externe draad - interne draad G2" - G1 1/2"	Q	18,14	21,95	
	QS050303	T-splitsing AISI 316 interne draad G3/8"	Q	4,50	5,45	
	QS050304	T-splitsing AISI 316 interne draad G1/2"	Q	4,92	5,95	
	QS050305	T-splitsing AISI 316 interne draad G3/4"	Q	7,81	9,45	
	QS050306	T-splitsing AISI 316 interne draad G1"	Q	12,36	14,95	
	QS050307	T-splitsing AISI 316 interne draad G1 1/4"	Q	18,97	22,95	
	QS050308	T-splitsing AISI 316 interne draad G1 1/2"	Q	23,10	27,95	
	QS050309	T-splitsing AISI 316 interne draad G2"	Q	34,67	41,95	
	QS050703	Elleboog connector 45° AISI 316 interne draad - interne draad G3/8"	Q	4,50	5,45	
	QS050704	Elleboog connector 45° AISI 316 interne draad - interne draad G1/2"	Q	4,92	5,95	
	QS050705	Elleboog connector 45° AISI 316 interne draad - interne draad G3/4"	Q	7,40	8,95	
	QS050706	Elleboog connector 45° AISI 316 interne draad - interne draad G1"	Q	11,53	13,95	
	QS050707	Elleboog connector 45° AISI 316 interne draad - interne draad G1 1/4"	Q	18,14	21,95	
	QS050708	Elleboog connector 45° AISI 316 interne draad - interne draad G1 1/2"	Q	23,10	27,95	
413	QS050403	Elleboog connector 90° AISI 316 interne draad - interne draad G3/8"	Q	3,88	4,70	

	QS050404	Elleboog connector 90° AISI 316 interne draad - interne draad G1/2"	Q	4,05	4,90
	QS050405	Elleboog connector 90° AISI 316 interne draad - interne draad G3/4"	Q	6,16	7,45
	QS050406	Elleboog connector 90° AISI 316 interne draad - interne draad G1"	Q	9,05	10,95
	QS050407	Elleboog connector 90° AISI 316 interne draad - interne draad G1 1/4"	Q	14,01	16,95
	QS050408	Elleboog connector 90° AISI 316 interne draad - interne draad G1 1/2"	Q	16,49	19,95
	QS050409	Elleboog connector 90° AISI 316 interne draad - interne draad G2"	Q	26,40	31,95
	QS050103	Elleboog connector 90° AISI 316 externe draad - interne draad G3/8"	Q	3,47	4,20
	QS050104	Elleboog connector 90° AISI 316 externe draad - interne draad G1/2"	Q	4,92	5,95
	QS050105	Elleboog connector 90° AISI 316 externe draad - interne draad G3/4"	Q	8,22	9,95
	QS050106	Elleboog connector 90° AISI 316 externe draad - interne draad G1"	Q	11,53	13,95
	QS050107	Elleboog connector 90° AISI 316 externe draad - interne draad G1 1/4"	Q	18,14	21,95
	QS050108	Elleboog connector 90° AISI 316 externe draad - interne draad G1 1/2"	Q	21,45	25,95
	QS050109	Elleboog connector 90° AISI 316 externe draad - interne draad G2"	Q	31,36	37,95
	QS050503	Ventiel AISI 316 externe draad - externe draad G3/8"	Q	2,56	3,10
	QS050504	Ventiel AISI 316 externe draad - externe draad G1/2"	Q	3,47	4,20
	QS050505	Ventiel AISI 316 externe draad - externe draad G3/4"	Q	4,92	5,95
	QS050506	Ventiel AISI 316 externe draad - externe draad G1"	Q	7,40	8,95
	QS050507	Ventiel AISI 316 externe draad - externe draad G1 1/4"	Q	10,70	12,95
	QS050508	Ventiel AISI 316 externe draad - externe draad G1 1/2"	Q	14,01	16,95
	QS050509	Ventiel AISI 316 externe draad - externe draad G2"	Q	20,62	24,95
	QS050803	Mof AISI 316 interne draad G3/8"	Q	2,81	3,40
	QS050804	Mof AISI 316 interne draad G1/2"	Q	4,05	4,90
	QS050805	Mof AISI 316 interne draad G3/4"	Q	4,92	5,95
	QS050806	Mof AISI 316 interne draad G1"	Q	9,05	10,95
	QS050807	Mof AISI 316 interne draad G1 1/4"	Q	12,36	14,95
	QS050808	Mof AISI 316 interne draad G1 1/2"	Q	16,49	19,95
	QS050809	Mof AISI 316 interne draad G2"	Q	20,62	24,95
414	AB16S	Ontluchtingsnippel roestvast staal Ø 16 mm. recht	Q	18,14	21,95
	AB16B	Ontluchtingsnippel roestvast staal Ø 16 mm. gebogen	Q	18,97	22,95
	AB19S	Ontluchtingsnippel roestvast staal Ø 19 mm. recht	Q	25,58	30,95
	AB19SL	Ontluchtingsnippel roestvast staal Ø 19 mm. recht, lang model	Q	26,40	31,95
	AB19B	Ontluchtingsnippel roestvast staal Ø 19 mm. gebogen	Q	26,40	31,95
	AB25B	Ontluchtingsnippel roestvast staal Ø 25 mm. gebogen	Q	26,40	31,95
	AB38B	Ontluchtingsnippel roestvast staal Ø 38 mm. gebogen	Q	37,98	45,95
	ST04HS	Ontluchtingsnippel RVS 316, slang Ø 16 mm, gebogen	Q	23,10	27,95
	ST04S	Ontluchtingsnippel RVS 316, slang Ø 16 mm, recht	Q	18,97	22,95
	ST05HS	Ontluchtingsnippel verzonken, RVS 316, slang Ø 16 mm, gebogen	Q	30,54	36,95
	ST05S	Ontluchtingsnippel verzonken, RVS 316, slang Ø 16 mm, recht	Q	23,93	28,95
415	CAPW38S	Dekdop "WATER" roestvast staal voor slang Ø 38 mm. deksel Ø 87 mm., L= 75 mm	Q	57,85	70,00
	CAPW38W	Dekdop "WATER" roestvast staal voor slang Ø 38 mm. deksel Ø 87 mm., L= 75 mm	Q	69,42	84,00
	CAPG38S	Dekdop "BENZINE" roestvast staal voor slang Ø 38 mm. deksel Ø 87 mm, L= 75 mm	Q	57,85	70,00
	CAPG38W	Dekdop "BENZINE" roestvast staal voor slang Ø 38 mm. deksel Ø 87 mm, L= 75 mm	Q	68,60	83,00
	CAPF38S	Dekdop "DIESEL FUEL" roestvast voor slang Ø 38 mm. deksel Ø 87 mm., L= 75 mm	Q	57,85	70,00
	CAPF38W	Dekdop "DIESEL FUEL" roestvast staal voor slang Ø 38 mm. deksel Ø 87 mm., L= 75 mm	Q	71,07	86,00
	CAPWC38S	Dekdop "WC" roestvast staal voor slang Ø 38 mm. deksel Ø 87 mm., L= 120 mm	Q	68,60	83,00
	CAPWC38W	Dekdop "WC" rvs voor slang Ø 38 mm. deksel Ø 88 mm. met winch aansluiting, L= 115 mm	Q	85,12	103,00
	CAPF51S	Dekdop "DIESEL FUEL" roestvast staal voor slang Ø 51 mm. deksel Ø 93 mm., L= 75 mm	Q	61,98	75,00
	CAPF51W	Dekdop "DIESEL FUEL" roestvast staal voor slang Ø 51 mm. deksel Ø 93 mm., L= 75 mm	Q	76,03	92,00
	KEY1	Sleutel voor dekdop	Q	9,05	10,95
	FCAPDF38	Dekdop "Diesel Fuel" voor slang Ø 38 mm met kettinkje en handgreep, deksel Ø 85 mm., L= 75 mm	Q	47,11	57,00
	FCAPDF50	Dekdop "Diesel Fuel" voor slang Ø 50 mm met kettinkje en handgreep, deksel Ø 85 mm., L= 75 mm	Q	45,45	55,00
	CAPWC38	Dekdop "WC" messing verchromd voor slang Ø 38 mm voor vuilwater, deksel Ø 90 mm., L= 120 mm	Q	63,64	77,00
	FCAPWATER	Dekdop "WATER" voor slang Ø 38 mm met kettinkje en handgreep, deksel Ø 85 mm., L= 75 mm	Q	44,63	54,00
SLANGKLE mm EN					
416	HCS08	Slangklem D 8-16 mm, RVS304 (Prijs per stuk)	Q	1,40	1,70
	HCS12	Slangklem D 12-22 mm, RVS304 (Prijs per stuk)	Q	1,57	1,90
	HCS16	Slangklem D 16-27 mm, RVS304 (Prijs per stuk)	Q	2,23	2,70
	HCS20	Slangklem D 20-32 mm, RVS304 (Prijs per stuk)	Q	2,48	3,00
	HCS25	Slangklem D 25-40 mm, RVS304 (Prijs per stuk)	Q	2,56	3,10
	HCS32	Slangklem D 32-50 mm, RVS304 (Prijs per stuk)	Q	2,64	3,20
	HCS40	Slangklem D 40-60 mm, RVS304 (Prijs per stuk)	Q	2,81	3,40
	HCS50	Slangklem D 50-70 mm, RVS304 (Prijs per stuk)	Q	2,89	3,50
	HCS60	Slangklem D 60-80 mm, RVS304 (Prijs per stuk)	Q	3,31	4,00











HCS75	Slangklem D 70-90 mm, RVS304 (Prijs per stuk)	Q	3,55	4,30	
HCS90	Slangklem D 90-110 mm, RVS304 (Prijs per stuk)	Q	3,80	4,60	
HCS110	Slangklem D 110-130 mm, RVS304 (Prijs per stuk)	Q	4,50	5,45	
HCS130	Slangklem D 130-150 mm, RVS304 (Prijs per stuk)	Q	4,50	5,45	
HCS150	Slangklem D 150-170 mm, RVS304 (Prijs per stuk)	Q	5,33	6,45	
HCHD034	Slangklem Heavy Duty D 34-37 mm (Prijs per stuk)	Q	3,06	3,70	
HCHD037	Slangklem Heavy Duty D 37-40 mm (Prijs per stuk)	Q	3,06	3,70	
HCHD040	Slangklem Heavy Duty D 40-50 mm (Prijs per stuk)	Q	3,06	3,70	
HCHD043	Slangklem Heavy Duty D 43-47 mm (Prijs per stuk)	Q	3,31	4,00	
HCHD047	Slangklem Heavy Duty D 47-51 mm (Prijs per stuk)	Q	3,55	4,30	
HCHD051	Slangklem Heavy Duty D 51-55 mm (Prijs per stuk)	Q	3,55	4,30	
HCHD055	Slangklem Heavy Duty D 55-59 mm (Prijs per stuk)	Q	3,80	4,60	
HCHD059	Slangklem Heavy Duty D 59-63 mm (Prijs per stuk)	Q	3,80	4,60	
HCHD063	Slangklem Heavy Duty D 63-68 mm (Prijs per stuk)	Q	3,80	4,60	
HCHD068	Slangklem Heavy Duty D 68-73 mm (Prijs per stuk)	Q	4,92	5,95	
HCHD073	Slangklem Heavy Duty D 73-79 mm (Prijs per stuk)	Q	4,92	5,95	
HCHD079	Slangklem Heavy Duty D 79-85 mm (Prijs per stuk)	Q	5,33	6,45	
HCHD085	Slangklem Heavy Duty D 85-91 mm (Prijs per stuk)	Q	5,33	6,45	
HCHD091	Slangklem Heavy Duty D 91-97 mm (Prijs per stuk)	Q	5,33	6,45	
HCHD097	Slangklem Heavy Duty D 97-104 mm (Prijs per stuk)	Q	5,33	6,45	
HCHD104	Slangklem Heavy Duty D 104-112 mm (Prijs per stuk)	Q	6,16	7,45	
HCHD112	Slangklem Heavy Duty D 112-121 mm (Prijs per stuk)	Q	7,81	9,45	
HCHD121	Slangklem Heavy Duty D 121-130 mm (Prijs per stuk)	Q	7,81	9,45	
HCHD130	Slangklem Heavy Duty D 130-140 mm (Prijs per stuk)	Q	10,70	12,95	
HCHD140	Slangklem Heavy Duty D 140-150 mm (Prijs per stuk)	Q	10,70	12,95	
HCHD150	Slangklem Heavy Duty D 150-162 mm (Prijs per stuk)	Q	11,53	13,95	
HCHD162	Slangklem Heavy Duty D 162-174 mm (Prijs per stuk)	Q	12,36	14,95	
HCHD174	Slangklem Heavy Duty D 174-187 mm (Prijs per stuk)	Q	12,36	14,95	
HCHD187	Slangklem Heavy Duty D 187-200 mm (Prijs per stuk)	Q	14,01	16,95	
HCHD200	Slangklem Heavy Duty D 200-213 mm (Prijs per stuk)	Q	14,01	16,95	
HCHD213	Slangklem Heavy Duty D 213-226 mm (Prijs per stuk)	Q	14,01	16,95	
HCHD260	Slangklem Heavy Duty D 263-276 mm (Prijs per stuk)	Q	50,41	61,00	
HCHD300	Slangklem Heavy Duty D 316-329 mm (Prijs per stuk)	Q	64,46	78,00	
HCHDS034	Slangklem Heavy Duty D 34-37 mm, RVS304 (Prijs per stuk)	Q	6,16	7,45	
HCHDS037	Slangklem Heavy Duty D 37-40 mm, RVS304 (Prijs per stuk)	Q	6,57	7,95	
HCHDS040	Slangklem Heavy Duty D 40-50 mm, RVS304 (Prijs per stuk)	Q	6,57	7,95	
HCHDS043	Slangklem Heavy Duty D 43-47 mm, RVS304 (Prijs per stuk)	Q	8,22	9,95	
HCHDS047	Slangklem Heavy Duty D 47-51 mm, RVS304 (Prijs per stuk)	Q	8,22	9,95	
HCHDS051	Slangklem Heavy Duty D 51-55 mm, RVS304 (Prijs per stuk)	Q	9,05	10,95	
HCHDS055	Slangklem Heavy Duty D 55-59 mm, RVS304 (Prijs per stuk)	Q	9,05	10,95	
HCHDS059	Slangklem Heavy Duty D 59-63 mm, RVS304 (Prijs per stuk)	Q	9,88	11,95	
HCHDS063	Slangklem Heavy Duty D 63-68 mm, RVS304 (Prijs per stuk)	Q	9,88	11,95	
HCHDS068	Slangklem Heavy Duty D 68-73 mm, RVS304 (Prijs per stuk)	Q	12,36	14,95	
HCHDS073	Slangklem Heavy Duty D 73-79 mm, RVS304 (Prijs per stuk)	Q	14,01	16,95	
HCHDS079	Slangklem Heavy Duty D 79-85 mm, RVS304 (Prijs per stuk)	Q	14,01	16,95	
HCHDS085	Slangklem Heavy Duty D 85-91 mm, RVS304 (Prijs per stuk)	Q	14,01	16,95	
HCHDS091	Slangklem Heavy Duty D 91-97 mm, RVS304 (Prijs per stuk)	Q	14,01	16,95	
HCHDS097	Slangklem Heavy Duty D 97-104 mm, RVS304 (Prijs per stuk)	Q	14,01	16,95	
HCHDS104	Slangklem Heavy Duty D 104-112 mm, RVS304 (Prijs per stuk)	Q	15,66	18,95	
HCHDS112	Slangklem Heavy Duty D 112-121 mm, RVS304 (Prijs per stuk)	Q	15,66	18,95	
HCHDS121	Slangklem Heavy Duty D 121-130 mm, RVS304 (Prijs per stuk)	Q	15,66	18,95	
HCHDS130	Slangklem Heavy Duty D 130-140 mm, RVS304 (Prijs per stuk)	Q	25,58	30,95	
HCHDS140	Slangklem Heavy Duty D 140-150 mm, RVS304 (Prijs per stuk)	Q	25,58	30,95	
HCHDS150	Slangklem Heavy Duty D 150-162 mm, RVS304 (Prijs per stuk)	Q	26,40	31,95	
HCHDS162	Slangklem Heavy Duty D 162-174 mm, RVS304 (Prijs per stuk)	Q	26,40	31,95	
HCHDS174	Slangklem Heavy Duty D 174-187 mm, RVS304 (Prijs per stuk)	Q	26,40	31,95	
HCHDS187	Slangklem Heavy Duty D 187-200 mm, RVS304 (Prijs per stuk)	Q	26,40	31,95	
HCHDS200	Slangklem Heavy Duty D 200-213 mm, RVS304 (Prijs per stuk)	Q	26,40	31,95	
HCHDS213	Slangklem Heavy Duty D 213-226 mm, RVS304 (Prijs per stuk)	Q	26,40	31,95	
HCHDS260	Slangklem Heavy Duty D 263-276 mm, RVS304 (Prijs per stuk)	Q	52,89	64,00	
HCHDS300	Slangklem Heavy Duty D 316-329 mm, RVS304 (Prijs per stuk)	Q	149,59	181,00	

BILGE POMPEN

417	BLP12500	Dompelpomp 2400 L/h (500 G/h), 12 V, uitgaande Ø 19 mm	Q	30,54	36,95	
	BLP121000	Dompelpomp 3000 L/h (1000 G/h), 12 V, uitgaande Ø 28.5 mm	Q	35,50	42,95	
	BLP122000	Dompelpomp 6600 L/h (2000 G/h), 12 V, uitgaande Ø 28.5 mm	Q	52,89	64,00	

	BLP123000	Dompelpomp 9600 L/h (3000 G/h), 12 V, uitgaande Ø 32 mm	Q	85,95	104,00
	BLP24500	Dompelpomp 2400 L/h (500 G/h), 24 V, uitgaande Ø 19 mm	Q	30,54	36,95
	BLP242000	Dompelpomp 6600 L/h (2000 G/h), 24 V, uitgaande Ø 28.5 mm	Q	52,89	64,00
	BLP243000	Dompelpomp 9600 L/h (3000 G/h), 24 V, uitgaande Ø 32 mm	Q	85,95	104,00
	BLSWITCH	Vlotterschakelaar, 19-50 mm, 12/24 V	Q	28,06	33,95
	BLPM020	Handpomp, 0,44 L/slag, voor Ø 32 mm slang	Q	26,40	31,95
	BLPS05	Hand plunjerpomp, 0,5 L/slag	Q	20,62	24,95
	BLPS08	Hand plunjerpomp, 0,8 L/slag	Q	23,10	27,95



KABEL BESTURING







	418	LCSKIT7	Light series kabel besturing kit, tot 55 PK, incl. besturinghuis, 90° montage beugel en 7 ft (213,5 cm) kabel.	Q	149,59	181,00
		LCSKIT8	Light series kabel besturing kit, tot 55 PK, incl. besturinghuis, 90° montage beugel en 8 ft (244 cm) kabel.	Q	151,24	183,00
		LCSKIT9	Light series kabel besturing kit, tot 55 PK, incl. besturinghuis, 90° montage beugel en 9 ft (274,5 cm) kabel.	Q	155,37	188,00
		LCSKIT10	Light series kabel besturing kit, tot 55 PK, incl. besturinghuis, 90° montage beugel en 10 ft (305 cm) kabel.	Q	157,85	191,00
		LCSKIT11	Light series kabel besturing kit, tot 55 PK, incl. besturinghuis, 90° montage beugel en 11 ft (335,5 cm) kabel.	Q	161,16	195,00
		LCSKIT12	Light series kabel besturing kit, tot 55 PK, incl. besturinghuis, 90° montage beugel en 12 ft (366 cm) kabel.	Q	166,12	201,00
		LCSKIT13	Light series kabel besturing kit, tot 55 PK, incl. besturinghuis, 90° montage beugel en 13 ft (396,5 cm) kabel.	Q	169,42	205,00
		LCSKIT14	Light series kabel besturing kit, tot 55 PK, incl. besturinghuis, 90° montage beugel en 14 ft (427 cm) kabel.	Q	171,90	208,00
		LCSKIT15	Light series kabel besturing kit, tot 55 PK, incl. besturinghuis, 90° montage beugel en 15 ft (457,5 cm) kabel.	Q	175,21	212,00
		LCSKIT16	Light series kabel besturing kit, tot 55 PK, incl. besturinghuis, 90° montage beugel en 16 ft (488 cm) kabel.	Q	177,69	215,00
		HZFKIT8	High performance ZF kabel besturing kit tot 125 PK, incl. besturinghuis, 90° montage beugel en 8 ft. (244 cm) kabel.	Q	222,31	269,00
		HZFKIT9	High performance ZF kabel besturing kit tot 125 PK, incl. besturinghuis, 90° montage beugel en 9 ft. (274,5 cm) kabel.	Q	222,31	269,00
		HZFKIT10	High performance ZF kabel besturing kit tot 125 PK, incl. besturinghuis, 90° montage beugel en 10 ft. (305 cm) kabel.	Q	222,31	269,00
		HZFKIT11	High performance ZF kabel besturing kit tot 125 PK, incl. besturinghuis, 90° montage beugel en 11 ft. (335,5 cm) kabel.	Q	230,58	279,00
		HZFKIT12	High performance ZF kabel besturing kit tot 125 PK, incl. besturinghuis, 90° montage beugel en 12 ft. (366 cm) kabel.	Q	230,58	279,00
		HZFKIT13	High performance ZF kabel besturing kit tot 125 PK, incl. besturinghuis, 90° montage beugel en 13 ft. (396,5 cm) kabel.	Q	238,84	289,00
		HZFKIT14	High performance ZF kabel besturing kit tot 125 PK, incl. besturinghuis, 90° montage beugel en 14 ft. (427 cm) kabel.	Q	238,84	289,00
		HZFKIT15	High performance ZF kabel besturing kit tot 125 PK, incl. besturinghuis, 90° montage beugel en 15 ft. (457,5 cm) kabel.	Q	238,84	289,00
		HZFKIT16	High performance ZF kabel besturing kit tot 125 PK, incl. besturinghuis, 90° montage beugel en 16 ft. (488 cm) kabel.	Q	247,11	299,00
		HZFKIT17	High performance ZF kabel besturing kit tot 125 PK, incl. besturinghuis, 90° montage beugel en 17 ft. (518,5 cm) kabel.	Q	247,11	299,00
		HZFKIT18	High performance ZF kabel besturing kit tot 125 PK, incl. besturinghuis, 90° montage beugel en 18 ft. (549 cm) kabel.	Q	255,37	309,00
		HZFKIT19	High performance ZF kabel besturing kit tot 125 PK, incl. besturinghuis, 90° montage beugel en 19 ft. (579,5 cm) kabel.	Q	255,37	309,00
		HZFKIT20	High performance ZF kabel besturing kit tot 125 PK, incl. besturinghuis, 90° montage beugel en 20 ft. (610 cm) kabel.	Q	255,37	309,00

OPTIES VOOR KABELBESTURING

	419	HB20	High Performance series 20° montage beugel kit	Q	18,97	22,95
		SQBALL	H en L series, stuur kabel Quick release kogelverbinding	Q	71,07	86,00

KABEL BESTURING ACCESSOIRES

		SLINK	H en L series, stuur kabel universele verbindingsarm	Q	63,64	77,00
		SSPLASH	H en L series, stuur kabel bun montage	Q	77,69	94,00
		STRANS	H en L series, stuur kabel spiegel montage, kort	Q	90,91	110,00
	420	STRANL	H en L series, stuur kabel spiegel montage, lang	Q	90,91	110,00
		LCAB5	Light series stuur kabel, tot 55 PK, 5ft.(152,5 cm)	Q	71,07	86,00
		LCAB6	Light series stuur kabel, tot 55 PK, 6ft.(183 cm)	Q	73,55	89,00
		LCAB7	Light series stuur kabel, tot 55 PK, 7ft.(213,5 cm)	Q	80,17	97,00
		LCAB8	Light series stuur kabel, tot 55 PK, 8ft.(244 cm)	Q	83,47	101,00
		LCAB9	Light series stuur kabel, tot 55 PK, 9ft.(274,5 cm)	Q	88,43	107,00
		LCAB10	Light series stuur kabel, tot 55 PK, 10ft.(305 cm)	Q	92,56	112,00

LCAB11	Light series stuur kabel, tot 55 PK, 11ft.(335,5 cm)	Q	97,52	118,00	
LCAB12	Light series stuur kabel, tot 55 PK, 12ft.(366 cm)	Q	100,83	122,00	
LCAB13	Light series stuur kabel, tot 55 PK, 13ft.(396,5 cm)	Q	107,44	130,00	
LCAB14	Light series stuur kabel, tot 55 PK, 14ft.(427 cm)	Q	112,40	136,00	
LCAB15	Light series stuur kabel, tot 55 PK, 15ft.(457,5 cm)	Q	117,36	142,00	
LCAB16	Light series stuur kabel, tot 55 PK, 16ft.(488 cm)	Q	121,49	147,00	
LCAB17	Light series stuur kabel, tot 55 PK, 17ft.(518,5 cm)	Q	125,62	152,00	
LCAB18	Light series stuur kabel, tot 55 PK, 18ft.(549 cm)	Q	127,27	154,00	
LCAB19	Light series stuur kabel, tot 55 PK, 19ft.(579,5 cm)	Q	131,40	159,00	
LCAB20	Light series stuur kabel, tot 55 PK, 20ft.(610 cm)	Q	132,23	160,00	
HCAB5	High performance series stuur kabel. tot 125 PK. 5 ft. (152,5 cm)	Q	93,39	113,00	
HCAB6	High performance series stuur kabel. tot 125 PK. 6 ft. (183 cm)	Q	97,52	118,00	
HCAB7	High performance series stuur kabel. tot 125 PK. 7 ft. (213,5 cm)	Q	100,83	122,00	
HCAB8	High performance series stuur kabel. tot 125 PK. 8 ft. (244 cm)	Q	106,61	129,00	
HCAB9	High performance series stuur kabel. tot 125 PK. 9 ft. (274,5 cm)	Q	112,40	136,00	
HCAB10	High performance series stuur kabel. tot 125 PK. 10 ft. (305 cm)	Q	114,88	139,00	
HCAB11	High performance series stuur kabel. tot 125 PK. 11 ft. (335,5 cm)	Q	119,83	145,00	
HCAB12	High performance series stuur kabel. tot 125 PK. 12 ft. (366 cm)	Q	125,62	152,00	
HCAB13	High performance series stuur kabel. tot 125 PK. 13 ft. (396,5 cm)	Q	131,40	159,00	
HCAB14	High performance series stuur kabel. tot 125 PK. 14 ft. (427 cm)	Q	133,88	162,00	
HCAB15	High performance series stuur kabel. tot 125 PK. 15 ft. (457,5 cm)	Q	139,67	169,00	
HCAB16	High performance series stuur kabel. tot 125 PK. 16 ft. (488 cm)	Q	145,45	176,00	
HCAB17	High performance series stuur kabel. tot 125 PK. 17 ft. (518,5 cm)	Q	151,24	183,00	
HCAB18	High performance series stuur kabel. tot 125 PK. 18 ft. (549 cm)	Q	155,37	188,00	
HCAB19	High performance series stuur kabel. tot 125 PK. 19 ft. (579,5 cm)	Q	160,33	194,00	
HCAB20	High performance series stuur kabel. tot 125 PK. 20 ft. (610 cm)	Q	166,12	201,00	

ANTISLIP

421	ANTI12HAP	Happy Elephant 90 x 120 cm (prijs per plaat)	Q		Gestopt. Vraag naar alternatieven
	ANTI24HAP	Happy Elephant 90 x 240 cm (prijs per plaat)	Q		Gestopt. Vraag naar alternatieven
	ANTI12SAF	Safari 90 x 120 cm (prijs per plaat)	Q		Gestopt. Vraag naar alternatieven
	ANTI24SAF	Safari 90 x 240 cm (prijs per plaat)	Q		Gestopt. Vraag naar alternatieven
	NOSKIDSBI	VETUS anti-slip zelfklevend (3M) EVA schuim, 240x90 cm, teak met bies look berken	Q	116,53	141,00
	NOSKIDSBL	VETUS anti-slip zelfklevend (3M) EVA schuim, 240x90 cm, teak met bies look zwart	Q	116,53	141,00
	NOSKIDSTE	VETUS anti-slip zelfklevend (3M) EVA schuim, 240x90 cm, teak look met bies naturel	Q	116,53	141,00
Nieuw!	NOSKIDFBI	VETUS anti-slip zelfklevend (3M) EVA schuim, 240x90 cm, volledig teak look voor randafwerking	Q	118,18	143,00
Nieuw!	NOSKIDFBL	VETUS anti-slip zelfklevend (3M) EVA schuim, 240x90 cm, volledig teak look zwart	Q	118,18	143,00
Nieuw!	NOSKIDFTE	VETUS anti-slip zelfklevend (3M) EVA schuim, 240x90 cm, volledig teak look naturel	Q	118,18	143,00
	BOATFIX1	Boatfix 1 ltr	Q	47,11	57,00

POLYWOOD

	SH06WXSH	Polywood plaat, wit, 1210 x 600 mm x 6 mm dikte	Q	59,50	72,00
	SH12WXSH	Polywood plaat, wit, 1210 x 600 mm x 12 mm dikte	Q	125,62	152,00
	SH18WXSH	Polywood plaat, wit, 1210 x 600 mm x 18 mm dikte	Q	169,42	205,00
	SH06WSH	Polywood plaat, wit, 1220 x 800 mm x 6 mm dikte	Q	66,12	80,00
	SH12WSH	Polywood plaat, wit, 1220 x 800 mm x 12 mm dikte	Q	128,93	156,00
	SH18WSH	Polywood plaat, wit, 1220 x 800 mm x 18 mm dikte	Q	192,56	233,00
	SH06WH	Polywood plaat, wit, 1220 x 2440 mm x 6 mm dikte	Q	181,82	220,00
	SH12WH	Polywood plaat, wit, 1220 x 2440 mm x 12 mm dikte	Q	362,81	439,00
	SH18WH	Polywood plaat, wit, 1220 x 2440 mm x 18 mm dikte	Q	544,63	659,00

Vraag naar de afwijkende verzendkosten voor dit product

WATERDICHT STOPCONTACT

422	SC29	Stopcontact, waterdicht met stekker, 2 polig, messing verchroomd	Q	23,93	28,95
	SC33	Stopcontact, waterdicht met stekker, 3 polig, messing verchroomd	Q	26,40	31,95
	SC44	Stopcontact, waterdicht met stekker, 4 polig, messing verchroomd	Q	26,40	31,95
	SC29L	Stopcontact, waterdicht met stekker, 2 polig, zware uitvoering, messing verchroomd	Q	28,06	33,95
	SC33L	Stopcontact, waterdicht met stekker, 3 polig, zware uitvoering, messing verchroomd	Q	28,06	33,95
	SC44L	Stopcontact, waterdicht met stekker, 4 polig, zware uitvoering, messing verchroomd	Q	30,54	36,95
	WDC2P	Watervaste deck aansluiting, 2 polig	C	20,62	24,95

HANG EN SLUITWERK

	LOCKDRC	Kunststof slot met verchroomde drukknop, 78 x 45 x 20 mm.	Q	31,36	37,95
	LOCKDRM	Kunststof slot met vermessingde drukknop, 78 x 45 x 20 mm.	Q	33,02	39,95





UITSTELPH Luik-uitsteller, type PH (202-368 mm)
UITSTELFE Ajustador acero inoxidable (AISI 316) tipo FE (261-485 mm)

Q 34,67 41,95
Q 37,98 45,95



423 **GASSP25** Gasveer, roestvast staal AISI 316, 180 - 254 mm. incl. aansluitingen
GASSP30 Gasveer, roestvast staal AISI 316, 220 - 305 mm. incl. aansluitingen
GASSP38 Gasveer, roestvast staal AISI 316, 240 - 380 mm. incl. aansluitingen
GASSP44 Gasveer, roestvast staal AISI 316, 280 - 440 mm. incl. aansluitingen
GASSP51 Gasveer, roestvast staal AISI 316, 305 - 510 mm. incl. aansluitingen

Q 78,51 95,00
Q 80,99 98,00
Q 85,12 103,00
Q 87,60 106,00
Q 90,08 109,00



VERREKIJKERS

BINO1 Verrekijker 7x50 met BK7 lenzen
BINO2 Waterdichte verrekijker 7x50 met BAK4 kwaliteits lenzen

Q 47,93 58,00
Q 132,23 160,00



ALUMINIUM- EN ZINK ANODEN

425 **ZINK02C** Zinkanode voor 23 kgf boegschroeftunnel
ZINK8C Huid-anode type 8, zink (excl. aansluitset)
ZINK15C Huid-anode type 15, zink (excl. aansluitset)
ZINK15SC Huid anode type 15S, zink (excl. aansluitset)
ZINK25C Huid-anode type 25, zink (excl. aansluitset)
ZINK25SC Huid anode type 25S, zink (excl. aansluitset)
ZINK35C Huid-anode type 35, zink (excl. aansluitset)
ALU08C Huid anode type 8, aluminium (excl. aansluitset)
ALU15C Huid anode type 15, aluminium (excl. aansluitset)
ALU15SC Huid anode type 15S, aluminium (excl. aansluitset)
ALU25C Huid anode type 25, aluminium (excl. aansluitset)
ALU25SC Huid anode type 25S, aluminium (excl. aansluitset)
ALU35C Huid anode type 35, aluminium (excl. aansluitset)
ZKITS Aansluitset staal voor huid-anode (per stuk)
ZKITP Aansluitset polyester voor huid-anode (per stuk)

ST 18,14 21,95
Q 23,10 27,95
Q 30,54 36,95
Q 30,54 36,95
Q 74,38 90,00
Q 74,38 90,00
Q 104,13 126,00
Q 21,45 25,95
Q 23,10 27,95
Q 23,10 27,95
Q 40,45 48,95
Q 40,45 48,95
Q 73,55 89,00
Q 12,36 14,95
Q 15,66 18,95



Nieuw! **BOA001Z** Huid-anode met schroefbevestiging 'Rechthoek' zink,0,24 kg
Nieuw! **BOA002Z** Huid-anode met schroefbevestiging 'Rechthoek' zink,0,50 kg
Nieuw! **BOA003A** Huid-anode met schroefbevestiging 'Rechthoek' aluminium, 0,44 kg
Nieuw! **BOA003Z** Huid-anode met schroefbevestiging 'Rechthoek' zink,0,94 kg
Nieuw! **BOA004A** Huid-anode met schroefbevestiging 'Rechthoek' aluminium, 0,87 kg
Nieuw! **BOA004Z** Huid-anode met schroefbevestiging 'Rechthoek' zink,1,94 kg
Nieuw! **BOA005A** Huid-anode met schroefbevestiging 'Rechthoek' aluminium, 1,52 kg
Nieuw! **BOA005Z** Huid-anode met schroefbevestiging 'Rechthoek' zink,3,40 kg
Nieuw! **BOA006A** Huid-anode met schroefbevestiging 'Rechthoek' aluminium, 2,40 kg
Nieuw! **BOA006Z** Huid-anode met schroefbevestiging 'Rechthoek' zink,5,60 kg
Nieuw! **BOA007A** Huid-anode met schroefbevestiging 'Rechthoek' aluminium, 4,50 kg
Nieuw! **BOA007Z** Huid-anode met schroefbevestiging 'Rechthoek' aluminium, 10,40 kg

Q 5,74 6,95
Q 10,70 12,95
Q 11,53 13,95
Q 15,66 18,95
Q 21,45 25,95
Q 33,02 39,95
Q 37,15 44,95
Q 59,50 72,00
Q 59,50 72,00
Q 84,30 102,00
Q 106,61 129,00
Q 148,76 180,00



Nieuw! **BOA021Z** Huid-anode met schroefbevestiging 'Plaat' zink,0,91 kg
Nieuw! **BOA022Z** Huid-anode met schroefbevestiging 'Plaat' zink,1,50 kg
Nieuw! **BOA023Z** Huid-anode met schroefbevestiging 'Plaat' zink,3,50 kg
Nieuw! **BOA024Z** Huid-anode met schroefbevestiging 'Plaat' zink,1,27 kg
Nieuw! **BOA025Z** Huid-anode met schroefbevestiging 'Plaat' zink,3,63 kg

Q 18,97 22,95
Q 30,54 36,95
Q 80,99 98,00
Q 26,40 31,95
Q 72,73 88,00











426 **WOA000Z** Las anode zink, 0,68 kg
WOA000A Las anode aluminium, 0,36 kg
WOA001Z Las anode zink, 1,07 kg
WOA001A Las anode aluminium, 0,55 kg
WOA002Z Las anode zink, 1,85 kg
WOA002A Las anode aluminium, 1,05 kg
WOA003Z Las anode zink, 2,27 kg
WOA003A Las anode aluminium, 1,1 kg
WOA004Z Las anode zink, 3,0 kg
WOA004A Las anode aluminium, 1,45 kg
WOA010Z Las anode zink, 1,0 kg
WOA010A Las anode aluminium, 0,55 kg
WOA011Z Las anode zink, 1,8 kg
WOA011A Las anode aluminium, 0,95 kg
WOA012Z Las anode zink, 2,7 kg
WOA012A Las anode aluminium, 1,26 kg





Q 14,01 16,95
Q 14,01 16,95
Q 20,62 24,95
Q 14,01 16,95
Q 33,02 39,95
Q 25,58 30,95
Q 39,63 47,95
Q 26,40 31,95
Q 50,41 61,00
Q 33,02 39,95
Q 20,62 24,95
Q 14,01 16,95
Q 33,02 39,95
Q 25,58 30,95
Q 47,93 58,00
Q 28,88 34,95



ZINK ANODEN

	ZINKAS25C	As-anode Ø 25 mm, zink	Q	18,14	21,95	
	ZINKAS30C	As-anode Ø 30 mm, zink	Q	16,49	19,95	
	ZINKAS35C	As-anode Ø 35 mm, zink	Q	26,40	31,95	
	ZINKAS40C	As-anode Ø 40 mm, zink	Q	33,02	39,95	
	ZINKAS45C	As-anode Ø 45 mm, zink	Q	33,02	39,95	
	ZINKAS50C	As-anode Ø 50 mm, zink	Q	33,02	39,95	
	ZINKAS60C	As-anode Ø 60 mm, zink	Q	61,98	75,00	
427	ZASA1C	As-anode, Ø 1", zink	Q	18,97	22,95	
	ZASA11/4C	As-anode, Ø 1.25", zink	Q	16,49	19,95	
	ZASA11/2C	As-anode, Ø 1.50", zink	Q	28,06	33,95	
	ZASA13/4C	As-anode, Ø 1.75", zink	Q	33,02	39,95	
	ZASA2C	As-anode, Ø 2", zink	Q	33,02	39,95	
	SAR25Z	As anode in zink, model "Ring" 0,31 kg	Q	10,70	12,95	
	SAR30Z	As anode in zink, model "Ring" 0,28 kg	Q	10,70	12,95	
	SAR35Z	As anode in zink, model "Ring" 0,25 kg	Q	10,70	12,95	
	SAR40Z	As anode in zink, model "Ring" 0,47 kg	Q	14,01	16,95	
	SAR45Z	As anode in zink, model "Ring" 0,44 kg	Q	14,01	16,95	
	SAR50Z	As anode in zink, model "Ring" 0,71 kg	Q	15,66	18,95	
	RAD50Z	Roer anode in zink, model "Schijf" 0,08 kg	Q	3,80	4,60	
	RAD70Z	Roer anode in zink, model "Schijf" 0,23 kg	Q	6,16	7,45	
	RAD90Z	Roer anode in zink, model "Schijf" 0,45 kg	Q	12,36	14,95	
	RAD110Z	Roer anode in zink, model "Schijf" 0,70 kg	Q	18,14	21,95	
	RAD140Z	Roer anode in zink, model "Schijf" 1,5 kg	Q	37,15	44,95	
	STAD001Z	Spiegelanode model "Schijf", 140 mm 2,7 kg	Q	66,94	81,00	
	STAD002Z	Spiegelanode model "Schijf", 140 mm 3,0 kg	Q	71,90	87,00	
	STAD003Z	Spiegelanode model "Schijf", 125 mm 2,7 kg	Q	66,94	81,00	
	STAD004Z	Spiegelanode model "Schijf", 135 mm 3,7 kg	Q	93,39	113,00	

















DOPMOER ANODES

428	SN25SET	Reserve zink anode set voor Ø 25 mm asmoer	Q	45,45	55,00	
	SN30SET	Reserve zink anode set voor Ø 30 mm schroefas	Q	47,93	58,00	
	SN35SET	Reserve zink anode set voor Ø 35 mm asmoer	Q	55,37	67,00	
	SN40SET	Reserve zink anode set voor Ø 40 mm asmoer	Q	71,07	86,00	
	SN45SET	Reserve zink anode set voor Ø 45 mm asmoer	Q	95,04	115,00	
	SN50SET	Reserve zink anode set voor Ø 50 mm asmoer	Q	126,45	153,00	
	SN60SET	Reserve zink anode set voor Ø 60 mm asmoer	Q	214,05	259,00	
	SET0148	Reserveset zinkanode voor boegschroef 25 kgf.	Q	16,49	19,95	
	SET0149	Reserveset zinkanode voor boegschroef 35 / 45 / 55 kgf.	Q	18,14	21,95	
	SET0150	Reserveset zinkanode voor boegschroef 60 / 75 / 80 / 95 kgf.	Q	18,14	21,95	
	SET0151	Reserveset zinkanode voor boegschroef 125 / 130 / 160 kgf.	Q	18,14	21,95	
	SET0152	Reserveset zinkanode voor boegschroef 220 kgf.	Q	18,14	21,95	
Nieuw!	SET0221	Reserveset zinkanode voor boegschroef 220 / 230 / 285 / 310 kgf.	Q	47,11	57,00	
	SET0153	Reserveset zinkanode voor boegschroef 23A / 50 / 80 kgf. en alle hekschroef-sets.	Q	12,36	14,95	

SLANGEN EN SMEERMIDDELEN

WATERSLANG

	DWBOSE10B	Drinkwaterslang, inw. Ø 10 mm (Rol van 30 meter, Prijs per meter)	C	5,33	6,45	
	DWBOSE12B	Drinkwaterslang, inw. Ø 12 mm (Rol van 30 meter, Prijs per meter)	C	5,33	6,45	
	DWBOSE16B	Drinkwaterslang, inw. Ø 16 mm (Rol van 30 meter, Prijs per meter)	C	6,98	8,45	
	DWBOSE19B	Drinkwaterslang, inw. Ø 19 mm (Rol van 30 meter, Prijs per meter)	C	10,70	12,95	
	DWBOSE25B	Drinkwaterslang, inw. Ø 25 mm (Rol van 30 meter, Prijs per meter)	C	13,18	15,95	
	DWBOSE28B	Drinkwaterslang, inw. Ø 28 mm (Rol van 30 meter, Prijs per meter)	C	19,79	23,95	
	DWBOSE30B	Drinkwaterslang, inw. Ø 30 mm (Rol van 30 meter, Prijs per meter)	C	16,49	19,95	
	DWBOSE32B	Drinkwaterslang, inw. Ø 32 mm (Rol van 30 meter, Prijs per meter)	C	19,79	23,95	
	DWBOSE35B	Drinkwaterslang, inw. Ø 35 mm (Rol van 30 meter, Prijs per meter)	C	21,45	25,95	
	DWBOSE38B	Drinkwaterslang, inw. Ø 38 mm (Rol van 30 meter, Prijs per meter)	C	21,45	25,95	
	DWBOSE40B	Drinkwaterslang, inw. Ø 40 mm (Rol van 10 meter, Prijs per meter)	C	23,10	27,95	
	DWBOSE45B	Drinkwaterslang, inw. Ø 45 mm (Rol van 10 meter, Prijs per meter)	C	28,06	33,95	
	DWBOSE50B	Drinkwaterslang, inw. Ø 50 mm (Rol van 10 meter, Prijs per meter)	C	28,06	33,95	

		BRANDSTOFSLANG (ISO-7840 - Marine Fuel A1)		
		FUHOSE05A	Brandstofslang, inw. Ø 5x11 mm iso 7840 marine fuel A1 (Rol van 30 meter, Prijs per meter)	C 9,88 11,95
		FUHOSE06A	Brandstofslang, inw. Ø 6 mm (Rol van 30 meter, Prijs per meter)	C 11,53 13,95
		FUHOSE08A	Brandstofslang, inw. Ø 8 mm (Rol van 30 meter, Prijs per meter)	C 12,36 14,95
		FUHOSE10A	Brandstofslang, inw. Ø 10 mm (Rol van 30 meter, Prijs per meter)	C 12,36 14,95
		FUHOSE13A	Brandstofslang, inw. Ø 13 mm (Rol van 30 meter, Prijs per meter)	C 15,66 18,95
		FUHOSE16A	Brandstofslang, inw. Ø 16 mm (Rol van 30 meter, Prijs per meter)	C 17,31 20,95
		FUHOSE19A	Brandstofslang, inw. Ø 19 mm (Rol van 30 meter, Prijs per meter)	C 24,75 29,95
		FUHOSE25A	Brandstofslang, inw. Ø 25 mm (Rol van 30 meter, Prijs per meter)	C 34,67 41,95
		BRANDSTOFSLANG (ISO-7840 - Marine Fuel A1 - 15)		
		FHA11506A	Brandstofslang 6 x 13 mm ISO 7840 (Rol van 30 meter, Prijs per meter)	B 11,53 13,95
		FHA11508A	Brandstofslang 8 x 16 mm ISO 7840 (Rol van 30 meter, Prijs per meter)	B 12,36 14,95
		FHA11510A	Brandstofslang 10 x 18 mm ISO 7840 (Rol van 30 meter, Prijs per meter)	B 13,18 15,95
		FHA11513A	Brandstofslang 13 x 22 mm ISO 7840 (Rol van 30 meter, Prijs per meter)	B 17,31 20,95
		VUILWATERSLANG (GRIJS WATER)		
	433	WWHOSE16B	Vuilwaterslang (grijs water), inw. Ø 16 mm (Rol van 30 meter, Prijs per meter)	C 5,33 6,45
		WWHOSE19B	Vuilwaterslang (grijs water), inw. Ø 19 mm (Rol van 30 meter, Prijs per meter)	C 9,05 10,95
		WWHOSE25B	Vuilwaterslang (grijs water), inw. Ø 25 mm (Rol van 30 meter, Prijs per meter)	C 12,36 14,95
		WWHOSE38B	Vuilwaterslang (grijs water), inw. Ø 38 mm (Rol van 30 meter, Prijs per meter)	C 20,62 24,95
		WWHOSE45B	Vuilwaterslang (grijs water), inw. Ø 45 mm (Rol van 10 meter, Prijs per meter)	C 24,75 29,95
		GEURDICHTE WATERSLANG		
		SAHOSE16	Geurdichte vuilwaterslang inw. Ø 16 mm (Rol van 20 meter, Prijs per meter)	C 15,66 18,95
		SAHOSE19	Geurdichte vuilwaterslang inw. Ø 19 mm (Rol van 20 meter, Prijs per meter)	C 16,49 19,95
		SAHOSE25	Geurdichte vuilwaterslang inw. Ø 25 mm (Rol van 20 meter, Prijs per meter)	C 20,62 24,95
		SAHOSE38	Geurdichte vuilwaterslang inw. Ø 38 mm (Rol van 20 meter, Prijs per meter)	C 26,40 31,95
		BLOWER-/VENTILATIESLANG		
		BLHOSE310A	Blower-/ ventilatorslang, inw. Ø 76 +/- 3 mm (3") (rol van 10 meter)	C 73,55 89,00
		BLHOSE410A	Blower-/ ventilatorslang, inw. Ø 102 mm (4") (rol van 10 meter)	C 85,95 104,00
		VHOSE152	Slang voor directe luchtvoorziening Ø 152 mm (prijs per meter)	A 61,98 75,00
		VHOSE178	Slang voor afzuigventilator Ø 178 mm. (prijs per meter)	A 61,98 75,00
		GESLOTEN KLIMAATSYSTEMESLANG		
		CCHOSE16	Slang voor gesloten klimaatsystemen, Ø 16 mm (Rol van 20 meter, prijs per meter)	C 26,40 31,95
		CCHOSE25	Slang voor gesloten klimaatsystemen, Ø 256 mm (Rol van 20 meter, (prijs per meter)	C 33,84 40,95
		KOELWATERSLANG		
		MWHOSE19	Koelwaterslang inw. Ø 19 mm. (Rol van 20 meter, Prijs per meter)	C 30,54 36,95
		MWHOSE25	Koelwaterslang inw. Ø 25 mm. (Rol van 20 meter, Prijs per meter)	C 33,02 39,95
		MWHOSE32	Koelwaterslang inw. Ø 32 mm. (Rol van 20 meter, Prijs per meter)	C 37,98 45,95
		MWHOSE38	Koelwaterslang inw. Ø 38 mm. (Rol van 20 meter, Prijs per meter)	C 43,80 53,00
		MWHOSE51	Koelwaterslang inw. Ø 51 mm. (Rol van 20 meter, Prijs per meter)	C 54,55 66,00
		WARM WATER EN BOILERSLANG		
		HWHOSE13	Warm water en boilerslang, inw. Ø 13 mm (Rol van 10 meter, Prijs per meter)	C 20,62 24,95
		HWHOSE16	Warm water en boilerslang, inw. Ø 16 mm (Rol van 10 meter, Prijs per meter)	C 26,40 31,95
		SILICONESLANG		
		SIHOSE25	Silicone slang inw. Ø 25,4 mm (1") (Rol van 20 meter, Prijs per meter)	C 52,07 63,00
		SIHOSE32	Silicone slang inw. Ø 32 mm (1 1/4") (Rol van 20 meter, Prijs per meter)	C 60,33 73,00
		SIHOSE38	Silicone slang inw. Ø 38 mm (1 1/2") (Rol van 20 meter, Prijs per meter)	C 67,77 82,00
		SIHOSE51	Silicone slang inw. Ø 50,8 mm (2") (Rol van 20 meter, Prijs per meter)	C 104,13 126,00
		SIHOSE63	Silicone slang inw. Ø 63,5 mm (2 1/2") (Rol van 20 meter, Prijs per meter)	C 125,62 152,00
		SIHOSE76	Silicone slang inw. Ø 76,2 mm (3") (Rol van 20 meter, Prijs per meter)	C 157,02 190,00
		SIHOSE102	Silicone slang inw. Ø 101,6 mm (4") (Rol van 20 meter, Prijs per meter)	C 230,58 279,00
		BRANDSTOF VULSLANG (ISO-7840-Marine Fuel A1 / SAE J 1527)		
		FFHOSE38	Brandstof-vulslang, inw. Ø 38 mm (Rol van 20 meter, Prijs per meter)	C 51,24 62,00
		FFHOSE51	Brandstof-vulslang, inw. Ø 51 mm (Rol van 20 meter, Prijs per meter)	C 64,46 78,00

UITLAATSLANGEN (Lloyd's goedgekeurd. Voldoet aan SAE-J 2006 R2)

SLANG30	Rubberen uitlaatslang, inw. Ø30 mm (Rol van 20 meter, Prijs per meter)	C	36,32	43,95
SLANG40	Rubberen uitlaatslang, inw. Ø40 mm (Rol van 20 meter, Prijs per meter)	C	40,45	48,95
SLANG45	Rubberen uitlaatslang, inw. Ø45 mm (Rol van 20 meter, Prijs per meter)	C	43,80	53,00
SLANG50	Rubberen uitlaatslang, inw. Ø51 mm (Rol van 20 meter, Prijs per meter)	C	46,28	56,00
SLANG57	Rubberen uitlaatslang, inw. Ø57 mm (Rol van 20 meter, Prijs per meter)	C	50,41	61,00
SLANG60	Rubberen uitlaatslang, inw. Ø60 mm (Rol van 20 meter, Prijs per meter)	C	52,89	64,00
SLANG65	Rubberen uitlaatslang, inw. Ø65 mm (Rol van 20 meter, Prijs per meter)	C	59,50	72,00
SLANG75	Rubberen uitlaatslang, inw. Ø76 mm (Rol van 20 meter, Prijs per meter)	C	65,29	79,00
SLANG90	Rubberen uitlaatslang, inw. Ø90 mm (Rol van 20 meter, Prijs per meter)	C	72,73	88,00
SLANG100	Rubberen uitlaatslang, inw. Ø102 mm (Rol van 20 meter, Prijs per meter)	C	76,03	92,00
SLANG110	Rubberen uitlaatslang, inw. Ø110 mm (Rol van 20 meter, Prijs per meter)	C	90,91	110,00
SLANG125	Rubberen uitlaatslang, inw. Ø127 mm (Rol van 20 meter, Prijs per meter)	C	109,09	132,00
SLANG150	Rubberen uitlaatslang, inw. Ø152 mm (Rol van 20 meter, Prijs per meter)	C	131,40	159,00
SLANG200	Rubberen uitlaatslang, inw. Ø203 mm (rol van 12 m, prijs per meter)	C	166,12	201,00
SLANG250	Rubberen uitlaatslang, inw. Ø254 mm (rol van 12m, prijs per meter)	C	263,64	319,00
SLANG300	Rubberen uitlaatslang, inw. Ø305 mm (rol van 12 m, prijs per meter)	C	313,22	379,00

UITLAATSLANGEN (RINA goedgekeurd)

Nieuw!	SLANG30R	Rubberen uitlaatslang, inw. Ø30 mm (Rol van 20 meter, Prijs per meter)	C	36,32	43,95
Nieuw!	SLANG40R	Rubberen uitlaatslang, inw. Ø40 mm (Rol van 20 meter, Prijs per meter)	C	42,98	52,00
Nieuw!	SLANG45R	Rubberen uitlaatslang, inw. Ø45 mm (Rol van 20 meter, Prijs per meter)	C	43,80	53,00
Nieuw!	SLANG50R	Rubberen uitlaatslang, inw. Ø51 mm (Rol van 20 meter, Prijs per meter)	C	46,28	56,00
Nieuw!	SLANG60R	Rubberen uitlaatslang, inw. Ø60 mm (Rol van 20 meter, Prijs per meter)	C	51,24	62,00
Nieuw!	SLANG65R	Rubberen uitlaatslang, inw. Ø65 mm (Rol van 20 meter, Prijs per meter)	C	59,50	72,00
Nieuw!	SLANG75R	Rubberen uitlaatslang, inw. Ø76 mm (Rol van 20 meter, Prijs per meter)	C	64,46	78,00
Nieuw!	SLANG90R	Rubberen uitlaatslang, inw. Ø90 mm (Rol van 20 meter, Prijs per meter)	C	71,90	87,00
Nieuw!	SLANG100R	Rubberen uitlaatslang, inw. Ø102 mm (Rol van 20 meter, Prijs per meter)	C	79,34	96,00
Nieuw!	SLANG110R	Rubberen uitlaatslang, inw. Ø110 mm (Rol van 20 meter, Prijs per meter)	C	82,64	100,00
Nieuw!	SLANG125R	Rubberen uitlaatslang, inw. Ø127 mm (Rol van 20 meter, Prijs per meter)	C	104,96	127,00
Nieuw!	SLANG150R	Rubberen uitlaatslang, inw. Ø152 mm (Rol van 20 meter, Prijs per meter)	C	132,23	160,00

SMEER- EN KOELMIDDELEN

435	VMD151	VETUS Marine Diesel Oil SAE 15W-40, 1 liter verpakking	Q	12,36	14,95	
	VMD154	VETUS Marine Diesel Oil SAE 15W-40, 4 liter verpakking	Q	37,98	45,95	
	VMD1520	VETUS Marine Diesel Oil SAE 15W-40, 20 liter verpakking	Q	158,68	192,00	
	VMD101	VETUS Marine Diesel Synthetic Engine Oil SAE 10W-40, 1 liter verpakking	Q	11,53	13,95	
	VMD104	VETUS Marine Diesel Synthetic Engine Oil SAE 10W-40, 4 liter verpakking	Q	40,45	48,95	
	VBT05	VETUS Special Gearbox Oil, 0,5 liter verpakking	Q	9,05	10,95	
	VTF1	VETUS Transmission Oil, 1 liter verpakking	Q	14,01	16,95	
	VHS1	VETUS Hydraulic Steering Oil HF15, 1 liter verpakking	Q	18,14	21,95	
	VHT1	VETUS Hydraulic Oil HT, 1 liter verpakking	Q	12,36	14,95	
	VHT4	VETUS Hydraulic Oil HT, 4 liter verpakking	Q	44,63	54,00	
	VHT20	VETUS Hydraulic Oil HT, 20 liter verpakking	Q	126,45	153,00	
	436	VTS1	VETUS Tweetakt buitenboordmotor olie, N mm A (BIA) TC-W3, 1 liter	Q	15,66	18,95
		VFS251	VETUS viertakt buitenboordmotor olie, 25W-40, 1 liter	Q	14,01	16,95
		VFS101	VETUS viertakt buitenboordmotor olie, 10W-30, 1 liter	Q	14,01	16,95
VTEFS		VETUS Teflon Spray, voor smering en bescherming tegen vuil en vocht, 400 ml	Q	15,66	18,95	
VSG		VETUS Scheepsvet, N.L.G.I. Klasse 2, DIN 51 502, KP 2 K-30, 600 gr.	Q	14,01	16,95	
VSD7505		VETUS Sterndrive olie, API: GL-4/5 SAE 75W-90, 500 ml	Q	9,88	11,95	
VOC1		VETUS Organic Coolant-38, 1 liter verpakking	Q	8,22	9,95	
VOC4		VETUS Organic Coolant-38, 4 liter verpakking	Q	28,06	33,95	
CARTERP		Aftappomp voor carterolie (zeewaterbestendig)	Q	39,63	47,95	



Index Catalogus

A	Aansluitingen	196, 404	Boegrollers	362 - 363
	Aansluitingen (hoek)	405	Boegschroefanoden	428
	Aansluitingen en nippels voor tanks	192	Boegschroefpanelen	220
	Aansluitkit vuilwatertanks	192	Boegschroeftunnels	218
	Aansluitkit watertanks	174	Boegschroefsystemen	197
	Aansluitset voor brandstoftanks	155	Boegschroeven	202
	Aanzuigpijp	175	Boegschroeven (hydraulisch)	214
	Accessoires voor boegschroeven	226 - 228	Boegschroeven 'extended runtime'	214
	Accubakken	255	Boilers	168 - 169
	Accukabels	260	Bolders	396
	Accukeuzeschakelaar	258	Bootstoelen	375
	Acculader/onderhouder	255	BOW PRO boegschroeven	205
	Acculaders	255	Brandstoffilters	148 -149, 151
	Accumulatortank	171	Brandstofgeurfilter	141
	Accupoolklemmen	260	Brandstofoverloop	152
	Accu's	256 - 257	Brandstofsysteem	143
	Accuschakelaars	258	Brandstoftanks	153 - 154
	Accuscheiders	255	Buitenboordbesturing	279 - 280
	Afsluiters	192, 194, 406, 407	C	
	Afstandbedieningen ankerlieren	361	Carterpomp	436
	Afstandbedieningen boegschroeven	223	Cilinders	274 - 276
	Afstandbedieningen motoren	48 - 52	D	
	Afzuigventilatoren	319 - 321, 326 - 327	Dekbekleding (anti-slip)	421
	Akoestische materialen	62 - 66	Dekdoorvoeren	415
	Ankerketting	366	Dekventilatoren	316 - 317, 322 - 323
	Ankerlier bedieningspanelen	358, 361	Detectoren	141
	Ankerlieren	332, 334 - 357	Diesel filters	151
	Ankerlieren (hydraulisch)	342, 360	Dieselmotoren	18 - 43
	Ankerlieren accessoires	361 - 367	Differentiaal-apparaten	53
	Ankers	364	Diode splitter	255
	Anoden	424	Doradeboxen	324
	As-anodes	426	Draadloze afstandsbediening	273
	Assen	90	Drive voor schroefassen	88 - 89
B	Batterijhoofdschakelaars	228, 258	Duivelsklauw	363
	Bedieningsapparatuur ankerlier	358	E	
	Bedieningspaneel DC boegschroeven	220	Elektrische afstandsbediening (boegschroeven)	223
	Bedieningspaneel vuilwater tank	191	Elektrische motorbesturingen	50 - 52
	Bedieningspanelen (hydraulische boegschroeven)	222	Elektrische voortstuwing	67
	Bedieningspanelen boeg- en hekschroeven	221	E-Line	72 - 74
	Bedieningspanelen toiletten	184	E-POD	75
	Beluchters	116 - 117	Filters	56 - 59
	Beluchtingsklep	192	Fire port	61
	Benzinedetector	141	F	
	Bevestiging voor waterlocks	122	Flexibele keerkoppelingen	84 - 87
	Bilgepompen	417	Flexibele tanks	190
	Bilgepompen vuilwater	191	Flush luik	298
			Fly bridge hatch	305
			Fuelsafe	158
			G	
			Gas/waterscheiders	118
			Gasveren	423
			Geluiddemper	112, 114

	Geluidisolatie	62 - 66		Koelwaterfilters	56 - 59
	Generatoren	252 - 253		Kogelgewricht	53
	Geurfilters	157, 190		Koperen leiding	282
	Geurfilters (vuilwater)	190	L	Ladders	392
	Geurfilters voor dieselolie	157		Luiken	294 - 300
H	Handreling	395		Luikheffers	422
	Handvatten	365	M	Maxwell ankersystemen	329
	Hang- en sluitwerk	422		Mechanische motorafstandbediening	48 - 49
	Hangdeuren	305		Mengkraan (thermostatisch)	175
	Hekschroeven	214-216		Meters en indicatoren	132 - 136
	Homokinetische koppelingen	88 - 89		Mixer	122
	Hoofdstroomschakelaar en noodstop	227		Montagebeugels	66
	Hoorns	391		Motor afstandsbedieningen	48 - 49
	Huiddoorvoeren	408, 410 - 411		Motoren	18 - 44
	Hydraulisch bekrachtigde besturing	242		Motorinstrumenten panelen	127 - 131
	Hydraulisch boeg- en hekschroeven	239 - 240		Motorsteunen (flexibel)	54 - 55
	Hydraulisch powerpack	245	N	Navigatieverlichting	403
	Hydraulische ankerlier	248		Niveauschakelaar	417
	Hydraulische boegschroef bediening (joystick)	222		Niveausensors	138
	Hydraulische buitenboordbesturing	279 - 280		Nylon slang	281
	Hydraulische luikheffers	247	O	Olie-/waterafscheider	60
	Hydraulische olie	235		Oliekoeler	243
	Hydraulische pompen	233		Ontluchtingsnippels	404, 414
	Hydraulische steunen	234	P	Paddestoelventilatoren	317
	Hydraulische stuur- en regeleenheden	236		Parallelschakelaar voor boeg- en hekschroef	228
	Hydraulische tanks	234		Poly-wood platen	421
	Hydraulische voorstuwing	244		Pompen	417
	Hydrofoor	170 - 171		Pompen (waterdruksysteem)	171
I	Inspectiedeksel	156, 173-174, 193		Pompflenzen	280
	Instrumenten (dashboard)	127 - 131		Poolklemmen (accu's)	260
	Instrumenten en sensoren voor tanks	135, 137		Poorten	289 - 293
	IP schroeven	215		Poten	355
J	Joystick (hydraulische boegschroef bediening)	221, 237		Power hydraulica	229
	Joystick boegschroef & stuursystemen	224 - 225		Power packs (elektrisch)	245
K	Kaapstanders	336 - 347		Power packs (hydraulisch)	32, 245
	Kabelbesturing	418	R	Proportionele kleppen	238
	Kabelklem	53		Ramen op maat	301 - 305
	Kabelklemmen	260		Regensensor (automatisch)	312
	Kabelschonen	260		Relais	259
	Kajuitingangen	304		Retractable boegschroef	216
	Kettingsnubbers	367		Rimdrive	209
	Kettingstopper	362 - 363		Roeren	283 - 284
	Kikkers	396		Roerstandaanwijzer unit	136
	Kleppen (proportioneel)	238		Roerstandaanwijzers	136
				Rubberlagers	99

Ruitenwisser bedieningspaneel	312	Stroomonderbreker	359
Ruitenwisser sproei-installatie	311 - 312	Stuurpompen	273 - 277
Ruitenwisserarmen en -bladen	306 - 310	Stuursystemen	263
Ruitenwissermotoren	306	Stuursysteemconfiguraties	272
Ruitenwissers	308 - 311	Stuursystemen voor beroepsvaart	277
Ruitenwissers heavy duty	310	Stuursystemen voor buitenboordmotoren	279 - 280
S Saildrive	30	Stuurwielen	267 - 271
Saildrive kit	30	Superjacht ankerlieren en kaapstanders	370
Sani-processor	185 - 186	Swivel	385
Scepterpot	395	T Tafelpoten	388
Scepters	395	Tafels	390
Schakelaars	247	Tank fresh	190
Schakelpanelen	140	Tank sensoren	191
Scheepsbeglazing	285	Tanks	153 - 154, 165 - 166, 187 - 189
Scheepsinstrumenten	123	Tanks brandstof	153 - 154
Schelpventilatoren	318	Tanks flexibel	167, 190
Schroefas anoden	98	Tanks vuilwater	187 - 189
Schroefassen	82 - 83	Tanks water	165 - 166
Schroefassystemen	79	Tankvlotters	173
Schroefassen en schroefaskokers	92 - 94	Terugslagklep	281
Schroeven	96 - 97	Tijdvertragingsschakelaar	226
Selectietabel accessoires ankerlieren	368 - 369	Toiletten	181 - 183
Slangaansluitingen	121 - 122, 404 - 409	Touw	367
Slangen	430	Touwsnijder	98
Slangklem	416	Trek-drukkabels	53
Slangkoppelingen	404 - 409	T-stukken	411, 412
Slangverbindingen	193	Tunnelbuizen (boeg- en hekschroeven)	218
Slingerruiten	309	U Uitlaat spiegeldoorvoeren	119
Smeermiddelen	435 - 436	Uitlaatsystemen	101
Snubbers	367	Ultrasonische sensor	138
Solas motoren	44	V V-CAN	8 - 11
Solenoids	259, 359	Ventilatie	313
Spanbanden	363, 367	Ventilatieluiken	294 - 298
Spare parts	437	Ventilator (elektrisch)	319
Spin-on filter	147 - 148	Ventilatoren	316 - 323
Splash-stop (brandstof)	152	Verbindingskabels (boeg- en hekschroeven)	226
Sproei-installatie voor wissers	311	Verbindingsonderdelen (stuursystemen)	282
Spruitstukken	407	Verrekijkers	423
Stabilisatoren	240 - 241	Verwarmingselement voor boilers	175
Stekkers met stopcontact (waterdicht)	422	Vluchtluiken	294 - 298
Stoelen	375	Voetschakelaars	359
Stoelhoezen	381	Vuilwater controlepaneel	191
Stoelpoten	383	Vuilwater pomp	191
Stootlijsten	398 - 401	Vuilwatersystemen	177
Stop-knop	53		
Stroom aan boord	249		

	Vuilwater tank accessoires	191 - 196
	Vuilwater tanks	187 - 190
	Vuilwater verbindingen	196
	V-Quipment	373
W	Walstroom	261 - 262
	Wartels	365
	Waterafscheider/brandsstoffilter	147 - 151
	Waterafscheider/filter	147 - 149
	Waterafscheiders/groffilters	60
	Waterdruksystemen	170 - 171
	Waterfilters	56 - 59
	Watergesmeerde schroefassen	90 - 95
	Waterlocks	106 - 110, 112
	Watermenger	122
	Waterschepjes	404, 406, 408
	Watersystemen	161
	Watertanks	165 - 166
Z	Zekeringen en zekeringhouders	228, 259
	Zink anodes	424
	Zoeklichten	402
	Zwanenhals	114 - 115
	Zwemtrappen	392

